

Silicon Deep Trench PIN Diodes

- Optimized for low bias current antenna switches in hand held applications
- Very low capacitance at zero volt reverse bias at frequencies above 1GHz (typ. 0.19 pF)
- Low forward resistance (typ. 1.3 Ω @ $I_F = 3$ mA)
- Improved ON / OFF mode harmonic distortion balance
- Pb-free (RoHS compliant) package¹⁾
- Qualified according AEC Q101

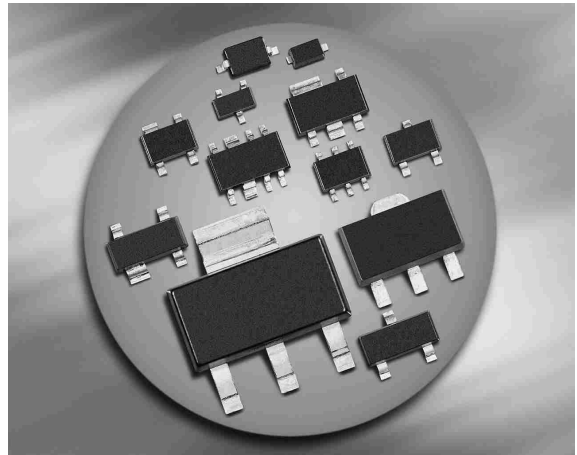

BAR90-02LRH BAR90-098LRH
BAR90-02LS

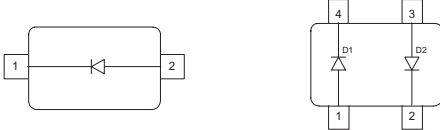

Type	Package	Configuration	L_S (nH)	Marking
BAR90-02LRH	TSLP-2-7	single, leadless	0.4	R9
BAR90-02LS	TSSLP-2-1	single, leadless	0.2	J
BAR90-098LRH	TSLP-4-7	anti-parallel pair, leadless	0.4	T9

¹Pb-containing package may be available upon special request

Maximum Ratings at $T_A = 25^\circ\text{C}$, unless otherwise specified

Parameter	Symbol	Value	Unit
Diode reverse voltage	V_R	80	V
Forward current	I_F	100	mA
Total power dissipation	P_{tot}		mW
$T_S \leq 137^\circ\text{C}$, BAR90-02LS		150	
$T_S \leq 133^\circ\text{C}$, all others		250	
Junction temperature	T_j	150	$^\circ\text{C}$
Operating temperature range	T_{op}	-55 ... 125	
Storage temperature	T_{stg}	-55 ... 150	

Thermal Resistance

Parameter	Symbol	Value	Unit
Junction - soldering point ¹⁾	R_{thJS}		K/W
BAR90-02LS		≤ 90	
all others		≤ 65	

Electrical Characteristics at $T_A = 25^\circ\text{C}$, unless otherwise specified

Parameter	Symbol	Values			Unit
		min.	typ.	max.	

DC Characteristics

Breakdown voltage $I_{(BR)} = 5 \mu\text{A}$	$V_{(BR)}$	80	-	-	V
Reverse current $V_R = 60 \text{ V}$	I_R	-	-	50	nA
Forward voltage $I_F = 3 \text{ mA}$ $I_F = 100 \text{ mA}$	V_F	0.75 -	0.81 0.9	0.87 1	V

¹For calculation of R_{thJA} please refer to Application Note Thermal Resistance

Electrical Characteristics at $T_A = 25^\circ\text{C}$, unless otherwise specified

Parameter	Symbol	Values			Unit
		min.	typ.	max.	
AC Characteristics					
Diode capacitance $V_R = 1\text{ V}, f = 1\text{ MHz}$ $V_R = 0\text{ V}, f = 100\text{ MHz}$ $V_R = 0\text{ V}, f = 1\text{ GHz}$ $V_R = 0\text{ V}, f = 1.8\text{ GHz}$	C_T	- - - -	0.25 0.3 0.19 0.18	0.35 - - -	pF
Reverse parallel resistance $V_R = 0\text{ V}, f = 100\text{ MHz}$ $V_R = 0\text{ V}, f = 1\text{ GHz}$ $V_R = 0\text{ V}, f = 1.8\text{ GHz}$	R_P	- - -	35 5 4	- - -	k Ω
Forward resistance $I_F = 1\text{ mA}, f = 100\text{ MHz}$ $I_F = 3\text{ mA}, f = 100\text{ MHz}$ $I_F = 10\text{ mA}, f = 100\text{ MHz}$	r_f	- - -	2 1.3 0.8	- 2.3 -	Ω
Charge carrier life time $I_F = 10\text{ mA}, I_R = 6\text{ mA}$, measured at $I_R = 3\text{ mA}$, $R_L = 100\ \Omega$	τ_{rr}	-	750	-	ns
I-region width	W_I	-	20	-	μm
Insertion loss ¹⁾ $I_F = 1\text{ mA}, f = 1.8\text{ GHz}$ $I_F = 3\text{ mA}, f = 1.8\text{ GHz}$ $I_F = 10\text{ mA}, f = 1.8\text{ GHz}$	I_L	- - -	0.16 0.11 0.08	- - -	dB
Isolation ¹⁾ $V_R = 0\text{ V}, f = 0.9\text{ GHz}$ $V_R = 0\text{ V}, f = 1.8\text{ GHz}$ $V_R = 0\text{ V}, f = 2.45\text{ GHz}$	I_{SO}	- - -	18.5 13.5 11.5	- - -	

¹⁾BAR90-02LRH in series configuration, $Z = 50\ \Omega$

Diode capacitance $C_T = f(V_R)$

$f =$ Parameter

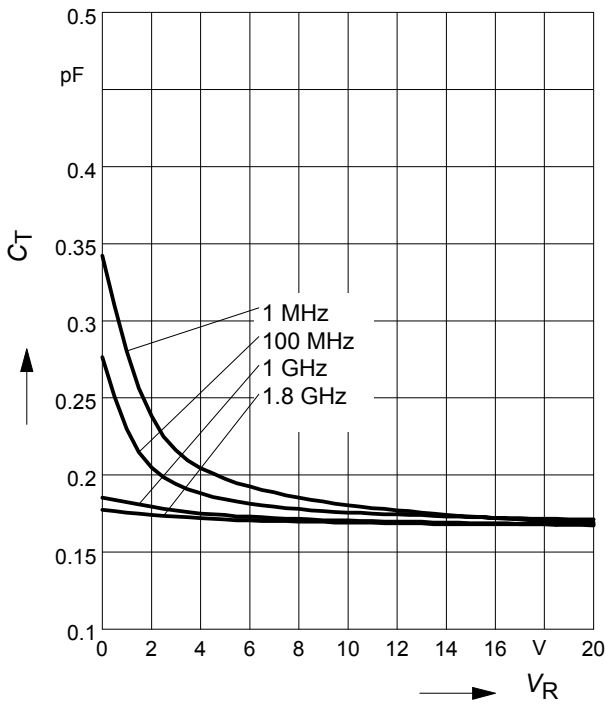

Reverse parallel resistance $R_p = f(V_R)$

$f =$ Parameter

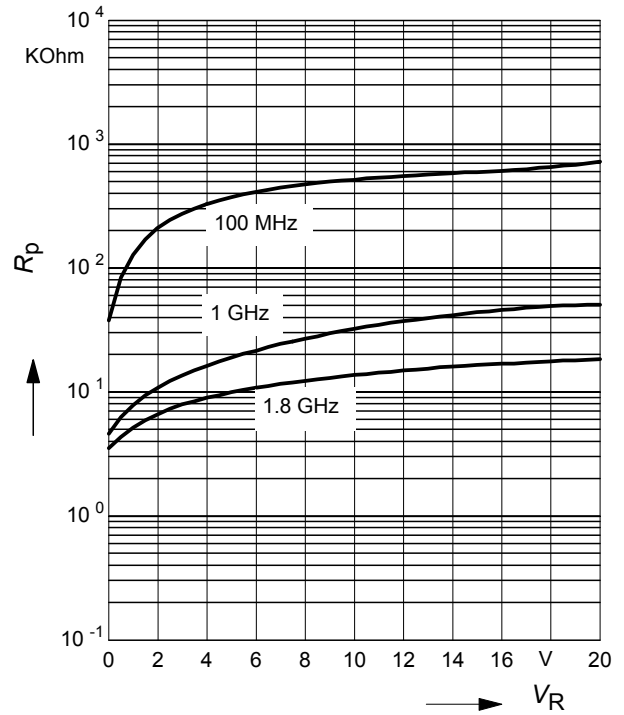

Forward resistance $r_f = f(I_F)$

$f = 100$ MHz

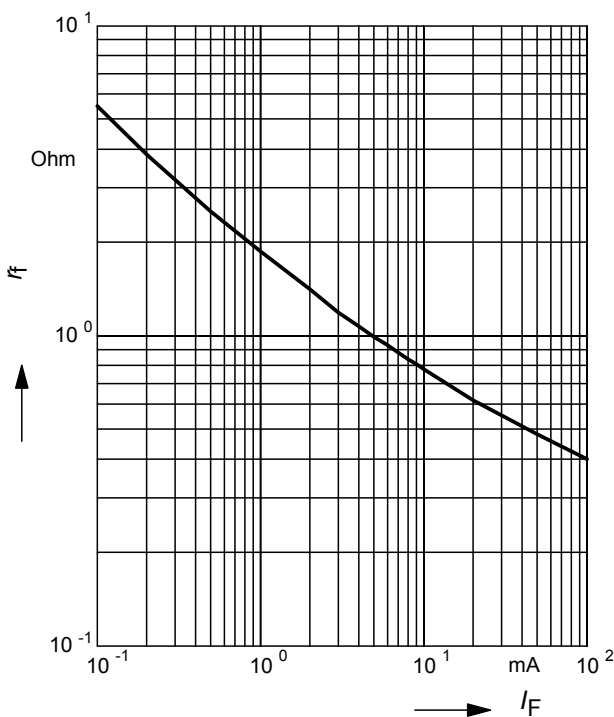

Forward current $I_F = f(V_F)$

$T_A =$ Parameter

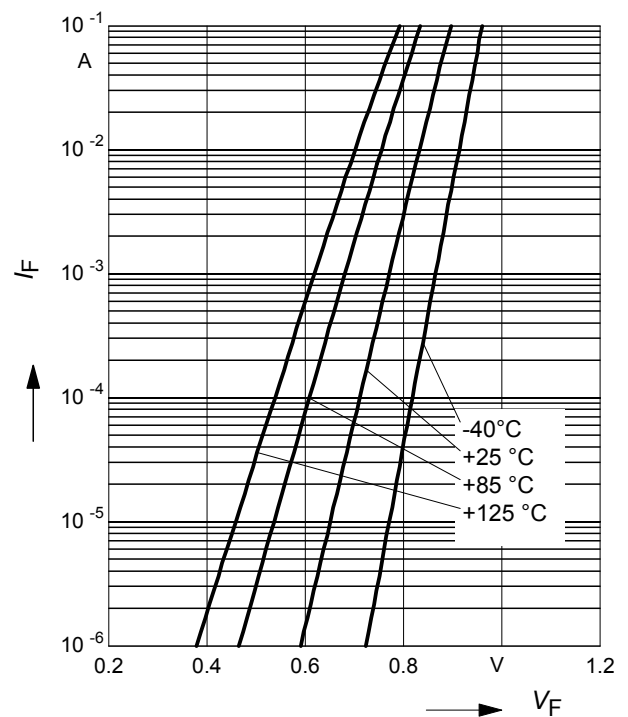

Forward current $I_F = f(T_S)$

BAR90-02LRH / -098LRH

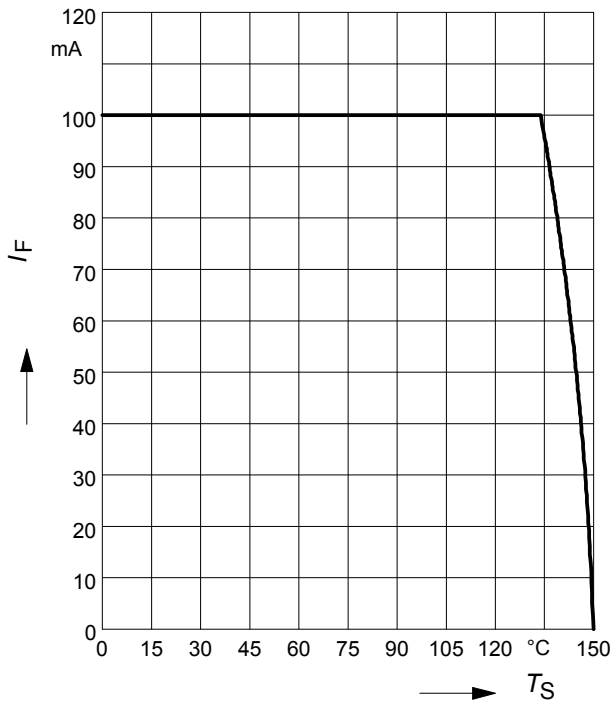

Forward current $I_F = f(T_S)$

BAR90-02LS

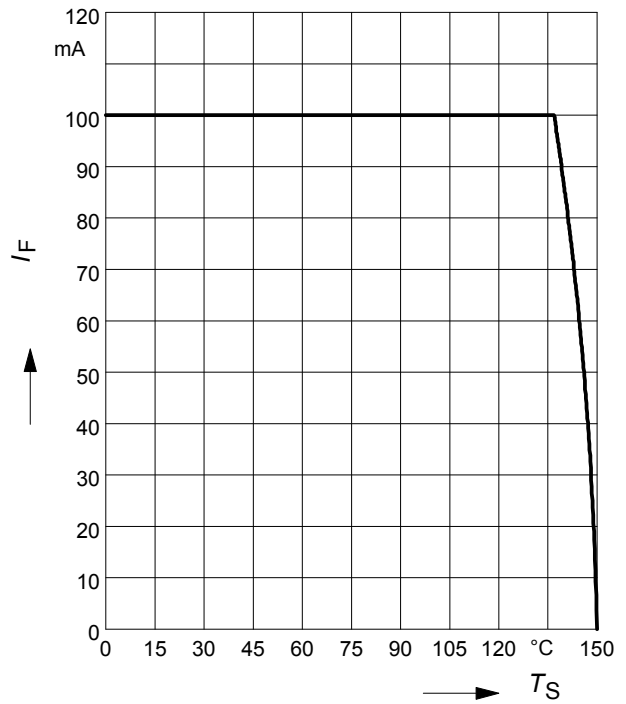

Permissible Puls Load $R_{thJS} = f(t_p)$

BAR90-02LRH / -098LRH

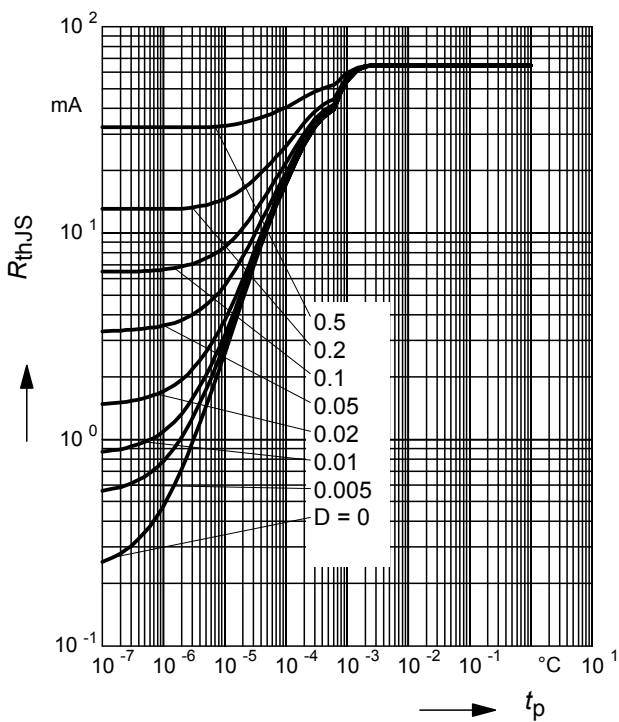

Permissible Pulse Load

$I_{Fmax} / I_{FDC} = f(t_p)$ BAR90-02LRH / -098LRH

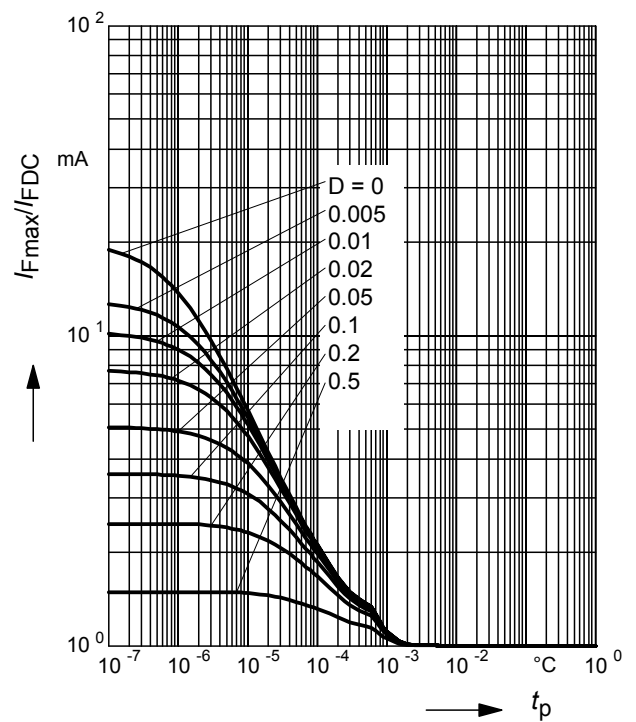

Permissible Puls Load $R_{thJS} = f(t_p)$

BAR90-02LS

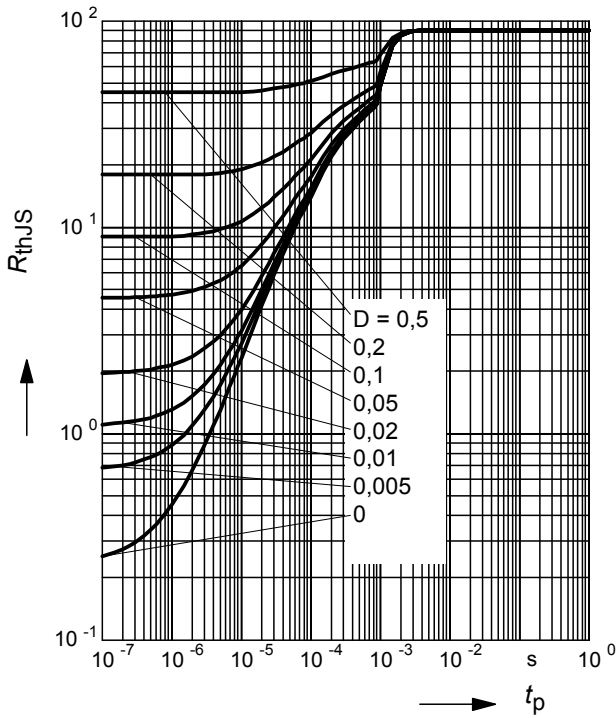

Permissible Pulse Load

$I_{Fmax} / I_{FDC} = f(t_p)$

BAR90-02LS

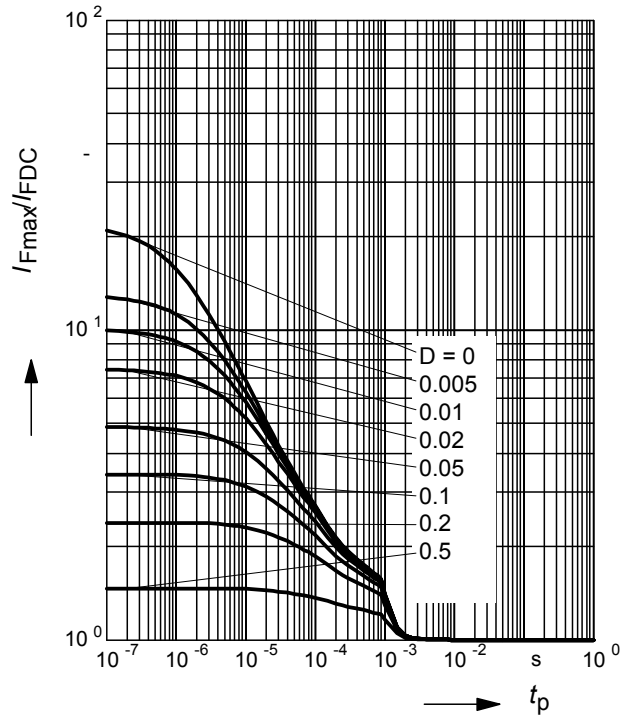

Insertion loss $I_L = -|S_{21}|^2 = f(f)$

I_F = Parameter

BAR90-02LRH in series configuration, $Z = 50\Omega$

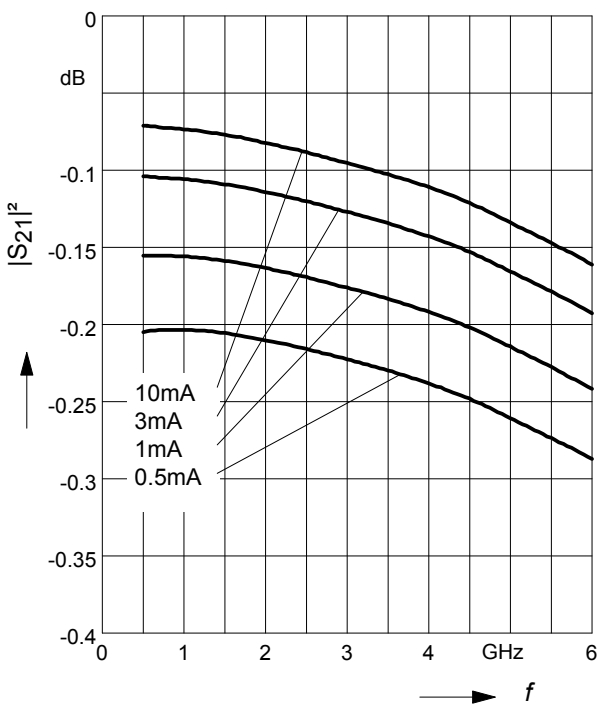

Isolation $I_{SO} = -|S_{21}|^2 = f(f)$

V_R = Parameter

BAR90-02LRH in series configuration, $Z = 50\Omega$

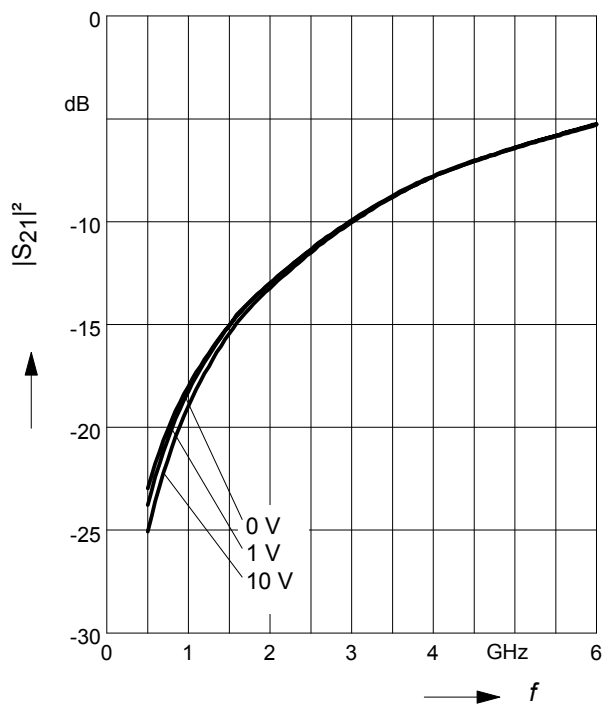

Package Outline

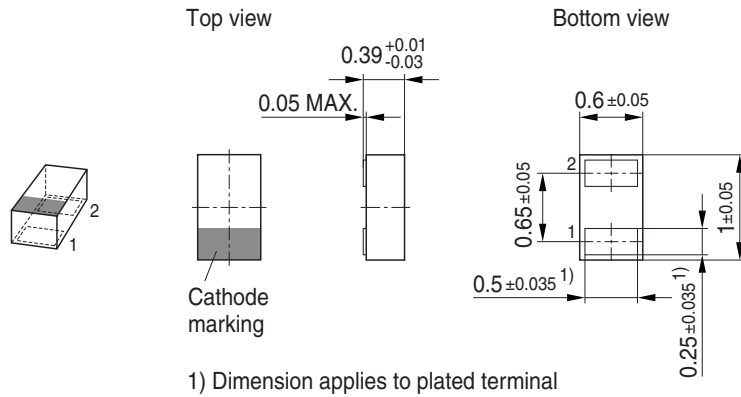

Foot Print

For board assembly information please refer to Infineon website "Packages"

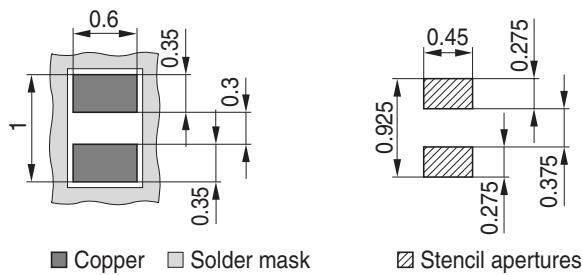

Marking Layout (Example)

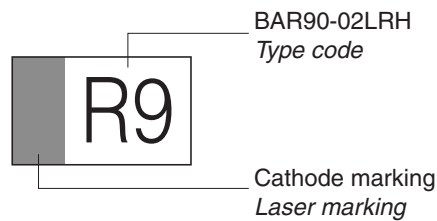

Standard Packing

Reel ø180 mm = 15.000 Pieces/Reel
 Reel ø330 mm = 50.000 Pieces/Reel (optional)

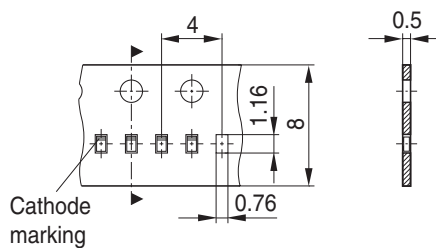

Package Outline

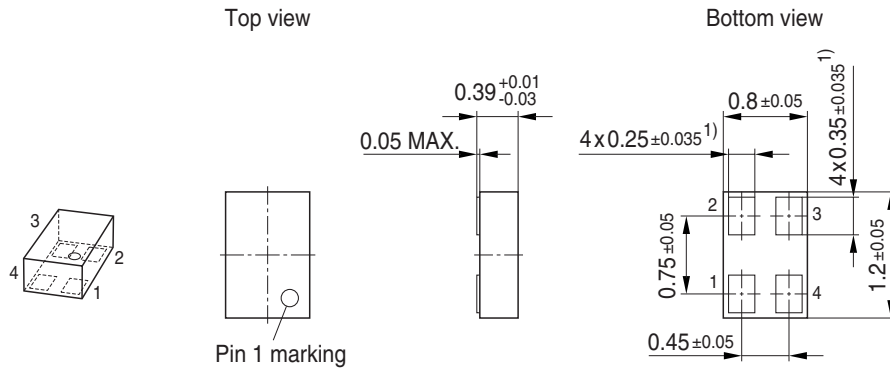

1) Dimension applies to plated terminal

Foot Print

For board assembly information please refer to Infineon website "Packages"

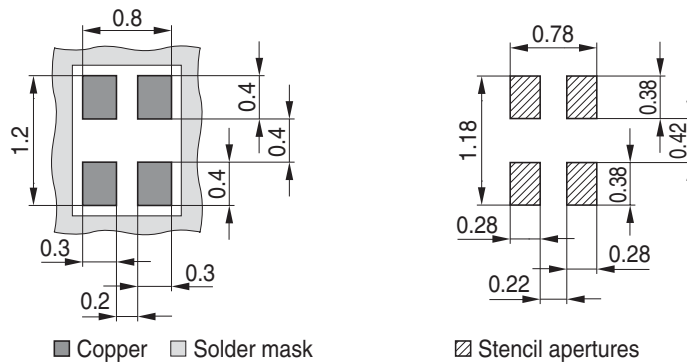

Marking Layout (Example)

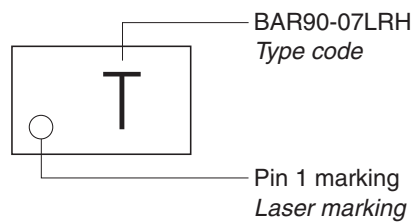

Standard Packing

Reel ø180 mm = 15.000 Pieces/Reel

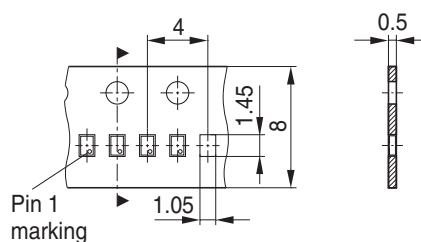

Package Outline

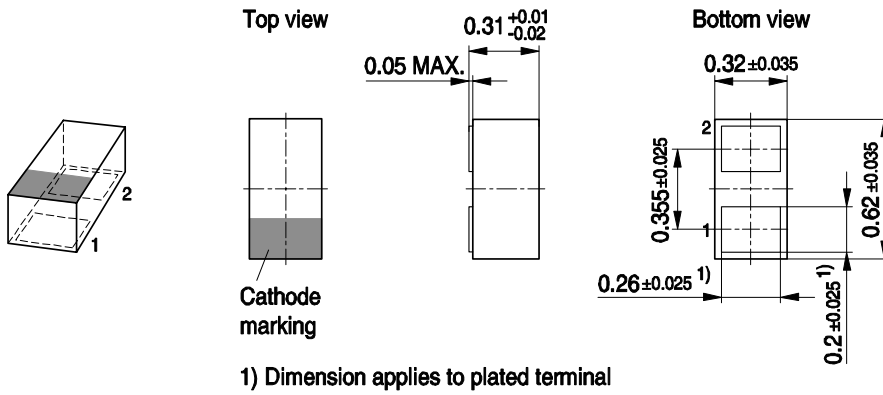

Foot Print

For board assembly information please refer to Infineon website "Packages"

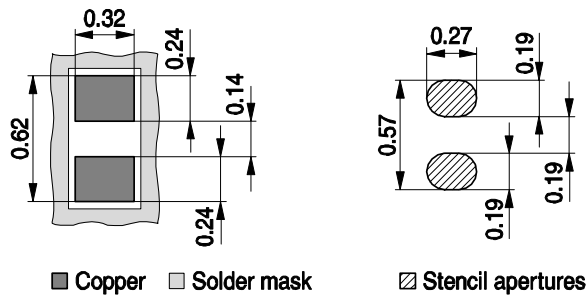

Marking Layout (Example)

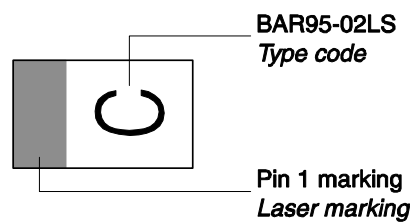

Standard Packing

Reel ø180 mm = 15.000 Pieces/Reel

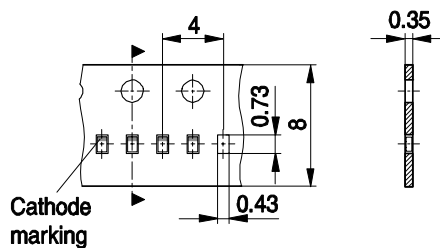

Edition 2009-11-16

**Published by
Infineon Technologies AG
81726 Munich, Germany**

**© 2009 Infineon Technologies AG
All Rights Reserved.**

Legal Disclaimer

The information given in this document shall in no event be regarded as a guarantee of conditions or characteristics. With respect to any examples or hints given herein, any typical values stated herein and/or any information regarding the application of the device, Infineon Technologies hereby disclaims any and all warranties and liabilities of any kind, including without limitation, warranties of non-infringement of intellectual property rights of any third party.

Information

For further information on technology, delivery terms and conditions and prices, please contact the nearest Infineon Technologies Office (www.infineon.com).

Warnings

Due to technical requirements, components may contain dangerous substances. For information on the types in question, please contact the nearest Infineon Technologies Office.

Infineon Technologies components may be used in life-support devices or systems only with the express written approval of Infineon Technologies, if a failure of such components can reasonably be expected to cause the failure of that life-support device or system or to affect the safety or effectiveness of that device or system. Life support devices or systems are intended to be implanted in the human body or to support and/or maintain and sustain and/or protect human life. If they fail, it is reasonable to assume that the health of the user or other persons may be endangered.