

Features

- **Industry-standard Architecture**
 - Low-cost, Easy-to-use Software Tools
- **High-speed, Electrically Erasable Programmable Logic Devices**
 - 5ns Maximum Pin-to-pin Delay
- **Latch Feature Holds Inputs to Previous Logic States**
- **Pin-controlled Standby Power (10 μ A Typical)**
- **Advanced Flash Technology**
 - Reprogrammable
 - 100% Tested
- **High-reliability CMOS Process**
 - 20-year Data Retention
 - 100 Erase/Write Cycles
 - 2,000V ESD Protection
 - 200mA Latch-up Immunity
- **Dual Inline and Surface Mount Packages in Standard Pinouts**
- **PCI-compliant**
- **Green Package Options (Pb/Halide-free/RoHS Compliant) Available**
- **Full Military, Commercial and Industrial Temperature Ranges**
- **Backward-Compatible with Atmel ATF22V10B(Q) and Atmel AT22V10(L)**
- **Applications Include Glue Logic for 5.0V Systems, DMA Control, State Machine Control, Graphics Processing**

1. Description

The Atmel[®] ATF22V10C is a high-performance CMOS (electrically erasable) programmable logic device (PLD) that utilizes proven electrically erasable Flash memory technology from Atmel. Speeds down to 5ns and power dissipation as low as 10 μ A (typical) are offered. All speed ranges are specified over the full 5V \pm 10% range for military and industrial temperature ranges, and 5V \pm 5% for commercial temperature ranges.

Several low-power options allow selection of the best solution for various types of power-limited applications. Each of these options significantly reduces total system power and enhances system reliability.



High-performance Electrically Erasable Programmable Logic Device

Atmel ATF22V10C
Atmel ATF22V10CQ

**See separate datasheet for
the Atmel ATF22V10C(Q)Z**



Figure 1-1. Logic Diagram

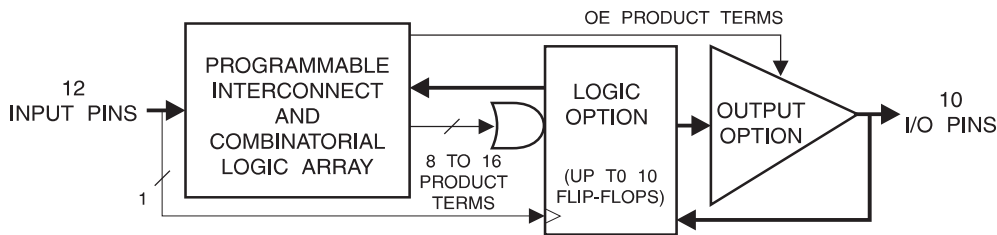

2. Pin Configurations

Table 2-1. Pin Configurations (All Pinouts Top View)

Pin Name	Function
CLK	Clock
IN	Logic Inputs
I/O	Bi-directional Buffers
GND	Ground
VCC	+5V Supply
PD	Power-down

Figure 2-1. TSSOP

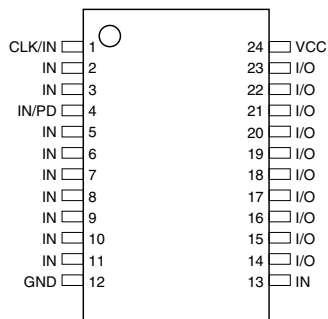

Figure 2-2. DIP/SOIC

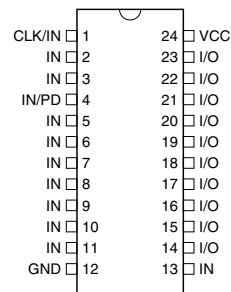
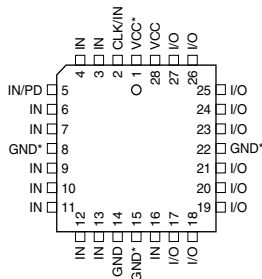

Figure 2-3. PLCC/LCC



Note: For all PLCCs (except "-5"), pins 1, 8, 15 and 22 can be left unconnected. However, if they are connected, superior performance will be achieved

3. Absolute Maximum Ratings*

Temperature under Bias	-55°C to +125°C
Storage Temperature.....	-65°C to +150°C
Voltage on Any Pin with Respect to Ground.....	-2.0V to +7.0V ⁽¹⁾
Voltage on Input Pins with Respect to Ground during Programming	-2.0V to +14.0V ⁽¹⁾
Programming Voltage with Respect to Ground.....	-2.0V to +14.0V ⁽¹⁾

*NOTICE: Stresses beyond those listed under “Absolute Maximum Ratings” may cause permanent damage to the device. This is a stress rating only and functional operation of the device at these or any other conditions beyond those indicated in the operational sections of this specification is not implied. Exposure to absolute maximum rating conditions for extended periods may affect device reliability.

Note: 1. Minimum voltage is -0.6V DC, which may undershoot to -2.0V for pulses of less than 20ns. Maximum output pin voltage is $V_{CC} + 0.75V$ DC, which may overshoot to 7.0V for pulses of less than 20ns.

4. DC and AC Operating Conditions

	Commercial	Industrial	Military
Operating Temperature (Ambient)	0°C - 70°C	-40°C - 85°C	-55°C - 125°C (case)
V_{CC} Power Supply	5V ± 5%	5V ± 10%	5V ± 10%



4.1 DC Characteristics

Symbol	Parameter	Condition	Min	Typ	Max	Units	
I_{IL}	Input or I/O Low Leakage Current	$0 \leq V_{IN} \leq V_{IL} \text{ (Max)}$			-10.0	μA	
I_{IH}	Input or I/O High Leakage Current	$3.5 \leq V_{IN} \leq V_{CC}$			10.0	μA	
I_{CC}	Power Supply Current, Standby	$V_{CC} = \text{Max},$ $V_{IN} = \text{Max},$ Outputs Open	C-5, 7, 10	Com.	85.0	130.0	mA
			C-10	Ind.	90.0	140.0	mA
			C-15	Ind.	65.0	115.0	mA
			CQ-15	Ind.	35.0	70.0	mA
I_{CC2}	Clocked Power Supply Current	$V_{CC} = \text{Max},$ Outputs Open, $f = 15\text{MHz}$	C-5, 7, 10	Com.		150.0	mA
			C-10	Ind., Mil.		160.0	mA
			C-15	Ind.	70.0	125	mA
			C-15	Mil.		160.0	mA
			CQ-15	Ind.	40.0	80.0	mA
I_{PD}	Power Supply Current, PD Mode	$V_{CC} = \text{Max}$	Com.	10.0	500.0	μA	
		$V_{IN} = 0, \text{Max}$	Ind.	10.0	650.0	μA	
$I_{OS}^{(1)}$	Output Short Circuit Current	$V_{OUT} = 0.5\text{V}$			-130.0	mA	
V_{IL}	Input Low Voltage		-0.5		0.8	V	
V_{IH}	Input High Voltage		2.0		$V_{CC}+0.75$	V	
V_{OL}	Output Low Voltage	$V_{IN} = V_{IH} \text{ or } V_{IL},$ $V_{CC} = \text{Min}$	$I_{OL} = 16\text{mA}$	Com., Ind.		0.5	V
			$I_{OL} = 12\text{mA}$	Mil.		0.5	V
V_{OH}	Output High Voltage	$V_{IN} = V_{IH} \text{ or } V_{IL},$ $V_{CC} = \text{Min}$	$I_{OH} = -4.0\text{mA}$		2.4		V

Note: 1. Not more than one output at a time should be shorted. Duration of short circuit test should not exceed 30 sec

4.2 AC Waveforms ⁽¹⁾

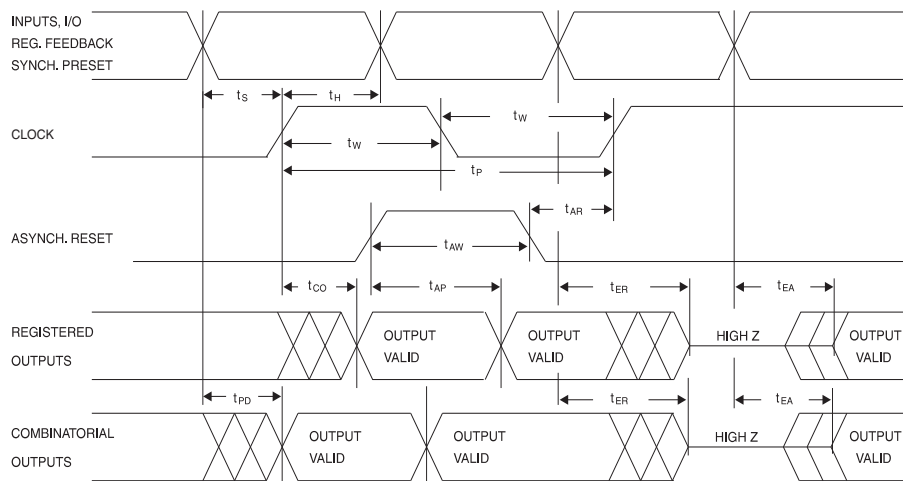

Note: 1. Timing measurement reference is 1.5V. Input AC driving levels are 0.0V and 3.0V, unless otherwise specified

4.3 AC Characteristics⁽¹⁾

Symbol	Parameter	-5		-7		-10		-15		Units
		Min	Max	Min	Max	Min	Max	Min	Max	
t _{PD}	Input or Feedback to Combinatorial Output	1.0	5.0	3.0	7.5	3.0	10.0	3.0	15.0	ns
t _{CO}	Clock to Output	1.0	4.0	2.0	4.5 ⁽²⁾	2.0	6.5	2.0	8.0	ns
t _{CF}	Clock to Feedback		2.5		2.5		2.5		2.5	ns
t _S	Input or Feedback Setup Time	3.0		3.5		4.5		10.0		ns
t _H	Hold Time	0		0		0		0		ns
f _{MAX}	External Feedback 1/(t _S + t _{CO})	142.0		125.0 ⁽³⁾		90.0		55.5		MHz
	Internal Feedback 1/(t _S + t _{CF})	166.0		142.0		117.0		80.0		MHz
	No Feedback 1/(t _{WH} + t _{WL})	166.0		166.0		125.0		83.3		MHz
t _W	Clock Width (t _{WL} and t _{WH})	3.0		3.0		3.0		6.0		ns
t _{EA}	Input or I/O to Output Enable	2.0	6.0	3.0	7.5	3.0	10.0	3.0	15.0	ns
t _{ER}	Input or I/O to Output Disable	2.0	5.0	3.0	7.5	3.0	9.0	3.0	15.0	ns
t _{AP}	Input or I/O to Asynchronous Reset of Register	3.0	7.0	3.0	10.0	3.0	12.0	3.0	20.0	ns
t _{AW}	Asynchronous Reset Width	5.5		7.0		8.0			15.0	ns
t _{AR}	Asynchronous Reset Recovery Time	4.0		5.0		6.0			10.0	ns
t _{SP}	Setup Time, Synchronous Preset	4.0		4.5		6.0			10.0	ns
t _{SPR}	Synchronous Preset to Clock Recovery Time	4.0		5.0		8.0			10.0	ns

- Notes:
1. See ordering information for valid part numbers
 2. 5.5ns for DIP package devices
 3. 111MHz for DIP package devices

4.4 Power-down AC Characteristics⁽¹⁾⁽²⁾⁽³⁾

Symbol	Parameter	-5		-7		-10		-15		Units
		Min	Max	Min	Max	Min	Max	Min	Max	
t_{IVDH}	Valid Input before PD High	5.0		7.5		10.0		15.0		ns
t_{GVDH}	Valid \overline{OE} before PD High	0		0		0		0		ns
t_{CVDH}	Valid Clock before PD High	0		0		0				ns
t_{DHIX}	Input Don't Care after PD High		5.0		7.0		10.0		15.0	ns
t_{DHGX}	\overline{OE} Don't Care after PD High		5.0		7.0		10.0		15.0	ns
t_{DHXC}	Clock Don't Care after PD High		5.0		7.0		10.0		15.0	ns
t_{DLIV}	PD Low to Valid Input		5.0		7.5		10.0		15.0	ns
t_{DLGV}	PD Low to Valid \overline{OE}		15.0		20.0		25.0		30.0	ns
t_{DLCV}	PD Low to Valid Clock		15.0		20.0		25.0		30.0	ns
t_{DLOV}	PD Low to Valid Output		20.0		25.0		30.0		35.0	ns

- Notes:
1. Output data is latched and held
 2. High-Z outputs remain high-Z
 3. Clock and input transitions are ignored

4.5 Input Test Waveforms

4.5.1 Input Test Waveforms and Measurement Levels

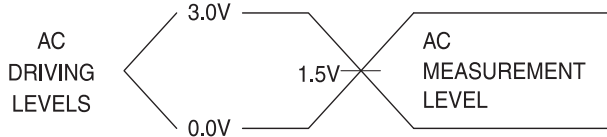

4.5.2 Commercial Output Test Loads

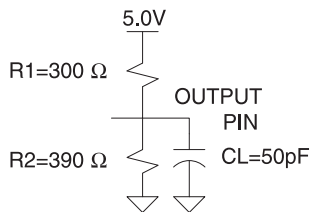

4.6 Pin Capacitance

Table 4-1. Pin Capacitance (f = 1MHz, T = 25°C⁽¹⁾)

	Typ	Max	Units	Conditions
C_{IN}	5	8	pF	$V_{IN} = 0V$
C_{OUT}	6	8	pF	$V_{OUT} = 0V$

- Note: 1. Typical values for nominal supply voltage. This parameter is only sampled and is not 100% tested

4.7 Power-up Reset

The registers in the Atmel® ATF22V10Cs are designed to reset during power-up. At a point delayed slightly from V_{CC} crossing V_{RST} , all registers will be reset to the low state. The output state will depend on the polarity of the output buffer.

This feature is critical for state machine initialization. However, due to the asynchronous nature of reset and the uncertainty of how V_{CC} actually rises in the system, the following conditions are required:

1. The V_{CC} rise must be monotonic, and starts below 0.7V
2. After reset occurs, all input and feedback setup times must be met before driving the clock pin high
3. The clock must remain stable during t_{PR}

Figure 4-1. Power-up Reset Timing

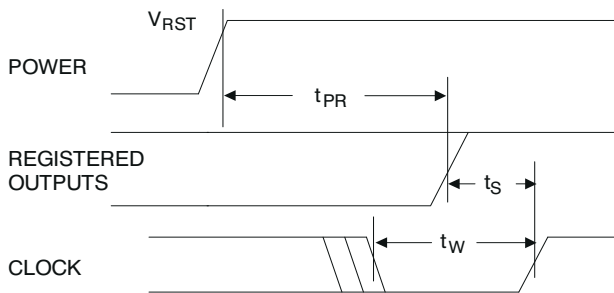

4.8 Preload of Registered Outputs

The ATF22V10C registers are provided with circuitry to allow loading of each register with either a high or a low. This feature will simplify testing since any state can be forced into the registers to control test sequencing. A JEDEC file with preload is generated when a source file with vectors is compiled. Once downloaded, the JEDEC file preload sequence will be done automatically by most of the approved programmers after the programming.

5. Electronic Signature Word

There are 64-bits of programmable memory that are always available to the user, even if the device is secured. These bits can be used for user-specific data.

6. Security Fuse Usage

A single fuse is provided to prevent unauthorized copying of the ATF22V10C fuse patterns. Once programmed, fuse verify and preload are inhibited. However, the 64-bit User Signature remains accessible.

The security fuse should be programmed last, as its effect is immediate.

7. Programming/Erasing

Programming/erasing is performed using standard PLD programmers. See “CMOS PLD Programming Hardware and Software Support” for information on software/programming.

Table 7-1. Programming/Erasing

Parameter	Description	Typ	Max	Units
t_{PR}	Power-up Reset Time	600	1,000	ns
V_{RST}	Power-up Reset Voltage	3.8	4.5	V

8. Input and I/O Pin-keeper Circuits

The Atmel® ATF22V10C contains internal input and I/O pin-keeper circuits. These circuits allow each ATF22V10C pin to hold its previous value even when it is not being driven by an external source or by the device's output buffer. This helps to ensure that all logic array inputs are at known valid logic levels. This reduces system power by preventing pins from floating to indeterminate levels. By using pin-keeper circuits rather than pull-up resistors, there is no DC current required to hold the pins in either logic state (high or low).

These pin-keeper circuits are implemented as weak feedback inverters, as shown in the Input Diagram below. These keeper circuits can easily be overdriven by standard TTL- or CMOS-compatible drivers. The typical overdrive current required is 40µA.

Figure 8-1. Input Diagram

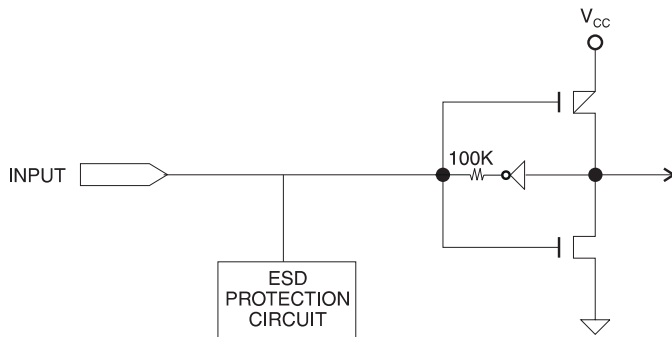
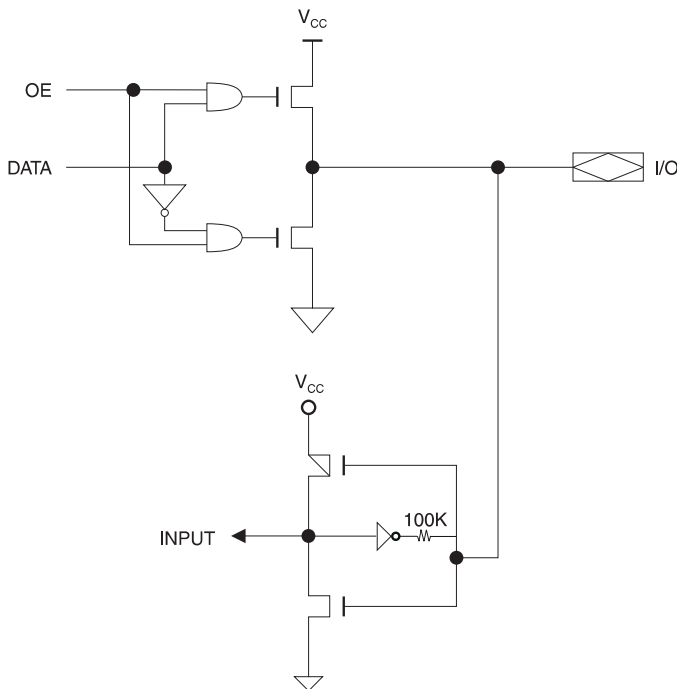

Figure 8-2. I/O Diagram



9. Power-down Mode

The Atmel® ATF22V10C includes an optional pin-controlled power-down feature. When this mode is enabled, the PD pin acts as the power-down pin (Pin 4 on the DIP/SOIC packages and Pin 5 on the PLCC package). When the PD pin is high, the device supply current is reduced to less than 100mA. During power-down, all output data and internal logic states are latched and held. Therefore, all registered and combinatorial output data remain valid. Any outputs that were in an undetermined state at the onset of power-down will remain at the same state. During power-down, all input signals except the power-down pin are blocked. Input and I/O hold latches remain active to ensure that pins do not float to indeterminate levels, further reducing system power. The power-down pin feature is enabled in the logic design file. Designs using the power-down pin may not use the PD pin logic array input. However, all other PD pin macrocell resources may still be used, including the buried feedback and foldback product term array inputs.

PD pin configuration is controlled by the design file, and appears as a separate fuse bit in the JEDEC file. When the power-down feature is not specified in the design file, the IN/PD pin will be configured as a regular logic input.

Note: Some programmers list the 22V10 JEDEC compatible 22V10C (no PD used) separately from the non-22V10 JEDEC compatible 22V10CEX (with PD used)

10. Compiler Mode Selection

Table 10-1. Compiler Mode Selection

	PAL Mode (5828 Fuses)	GAL Mode (5892 Fuses)	Power-down Mode⁽¹⁾ (5893 Fuses)
Synario	ATF22V10C (DIP) ATF22V10C (PLCC)	ATTF22V10C DIP (UES) ATF22C10C PLCC (UES)	ATF22V10C DIP (PWD) ATF22V10C PLCC (PWD)
WINCUPPL	P22V10 P22V10LCC	G22V10 G22V10LCC	G22V10CP G22V10CPLCC

Note: 1. These device types will create a JEDEC file which when programmed in Atmel ATF22V10C devices will enable the power-down mode feature. All other device types have the feature disabled

11. Functional Logic Diagram

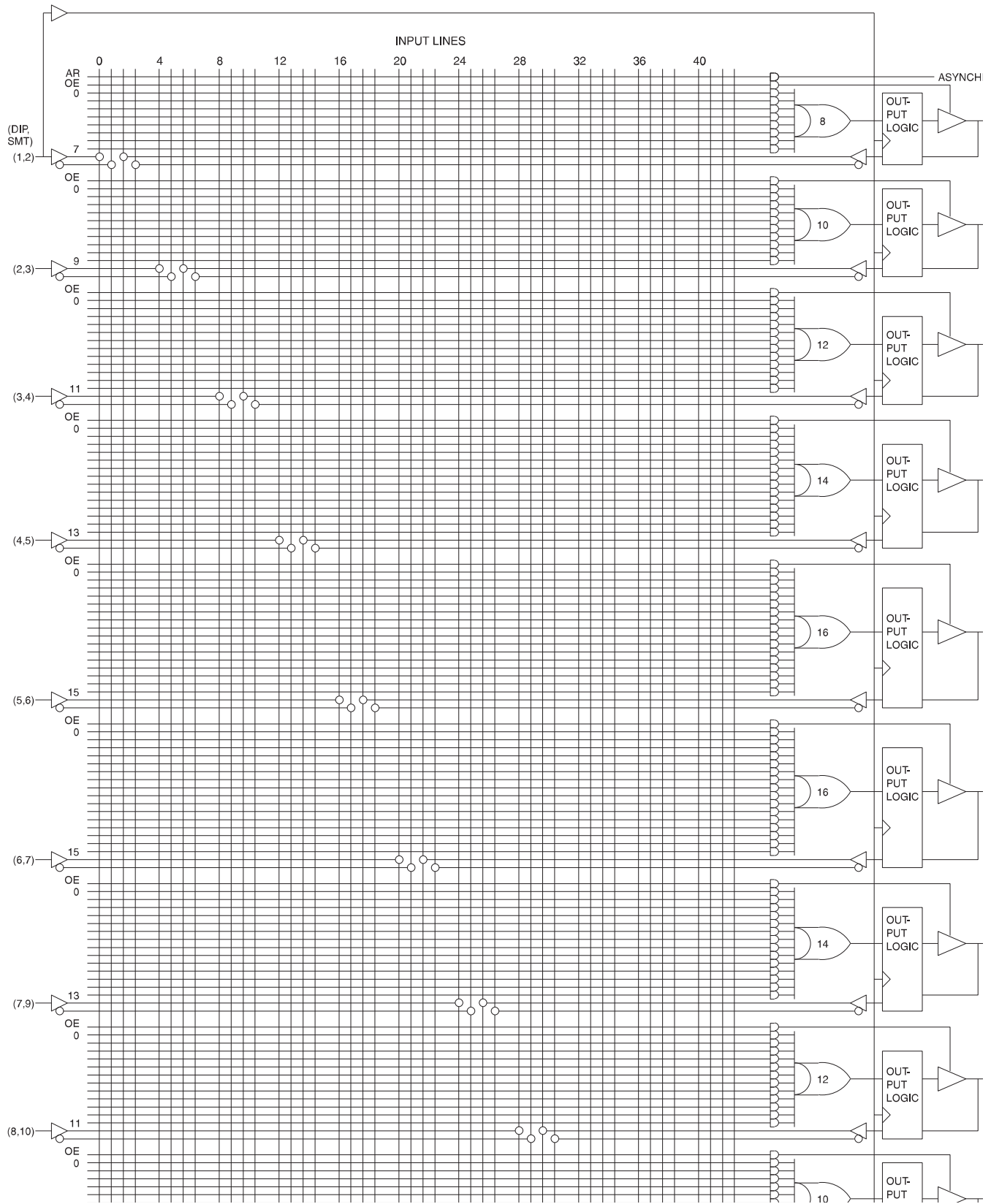

ATMEL ATF22V10C/CQ SUPPLY CURRENT VS. SUPPLY VOLTAGE ($T_A = 25^\circ\text{C}$)

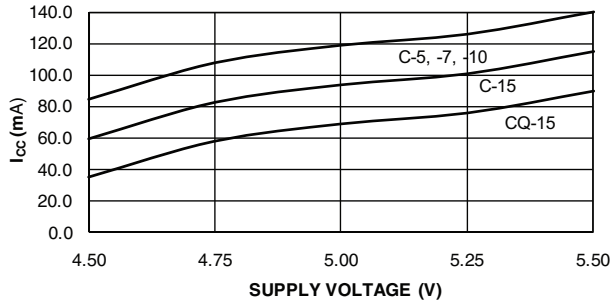

ATMEL ATF22V10C/CQ NORMALIZED I_{CC} VS. TEMPERATURE

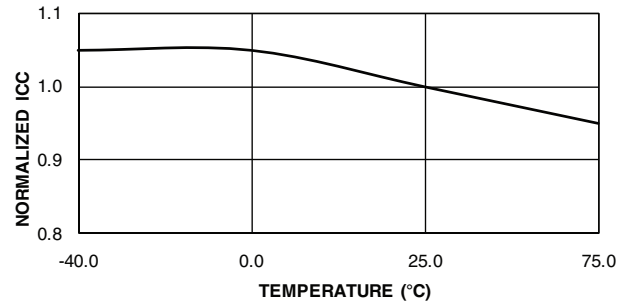

ATMEL ATF22V10C/CQ SUPPLY CURRENT VS. INPUT FREQUENCY ($V_{CC} = 5V, T_A = 25^\circ\text{C}$)

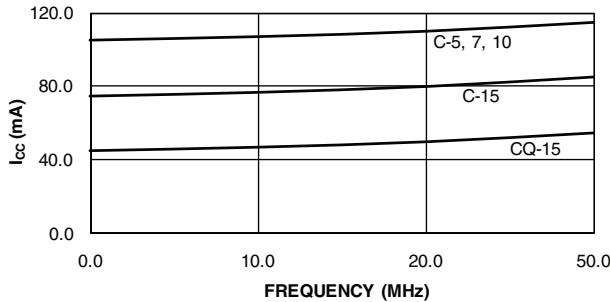

ATMEL ATF22V10C/CQ OUTPUT SOURCE CURRENT VS. OUTPUT VOLTAGE ($V_{CC} = 5V, T_A = 25^\circ\text{C}$)

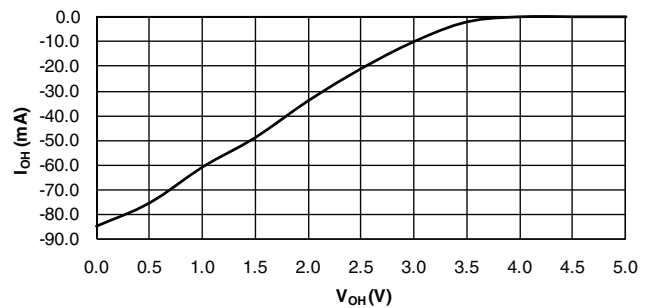

ATMEL ATF22V10C/CQ OUTPUT SOURCE CURRENT VS. SUPPLY VOLTAGE ($V_{OH} = 2.4V$)

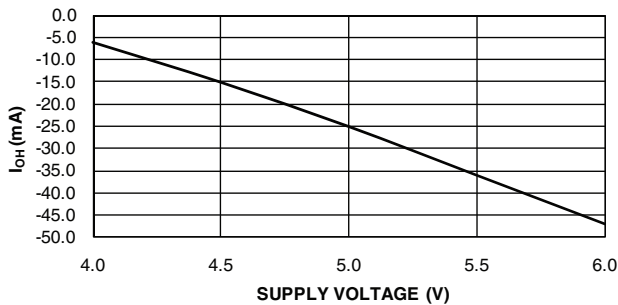

ATMEL ATF22V10C/CQ OUTPUT SINK CURRENT VS. SUPPLY VOLTAGE ($V_{OL} = 0.5V$)

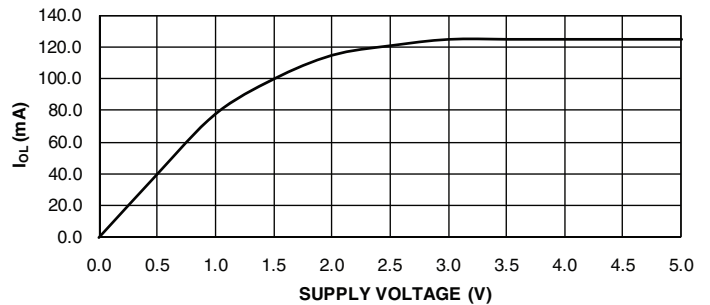

ATMEL ATF22V10C/CQ OUTPUT SINK CURRENT VS. SUPPLY VOLTAGE ($V_{OL} = 0.5V$)

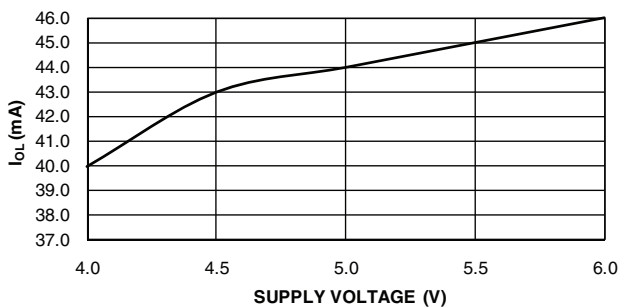

ATMEL ATF22V10C/CQ INPUT CLAMP CURRENT VS. INPUT VOLTAGE ($V_{CC} = 5V, T_A = 35^\circ\text{C}$)

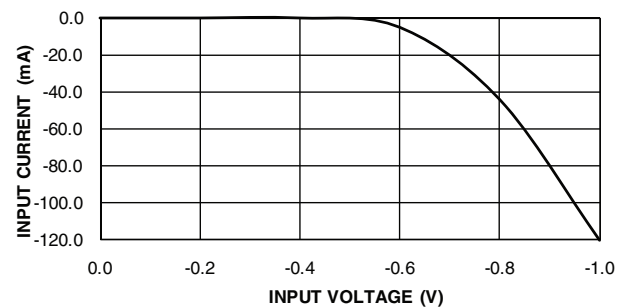

ATMEL ATF22V10C/CQ
NORMALIZED T_{PD} VS. V_{CC}

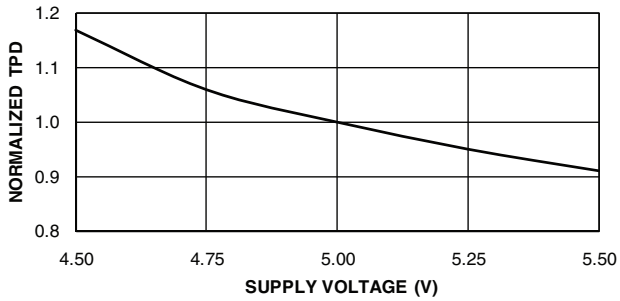

ATMEL ATF22V10C/CQ
NORMALIZED T_{CO} VS. TEMPERATURE

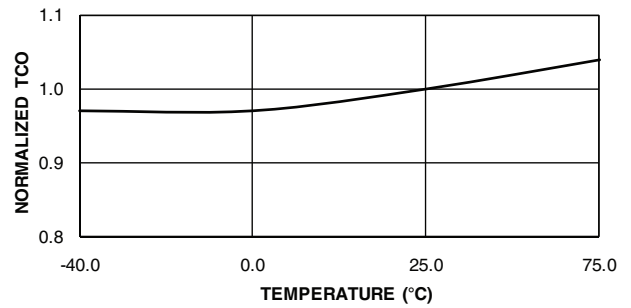

ATMEL ATF22V10C/CQ
NORMALIZED T_{CO} VS. V_{CC}

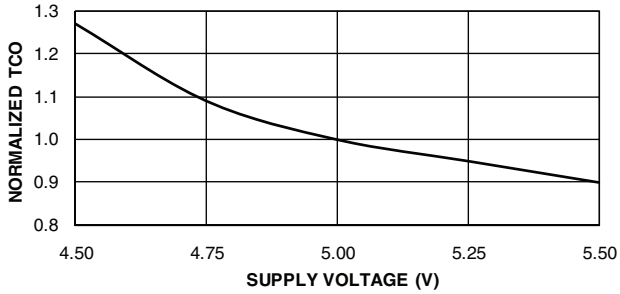

ATMEL ATF22V10C/CQ
NORMALIZED T_{SU} VS. TEMPERATURE

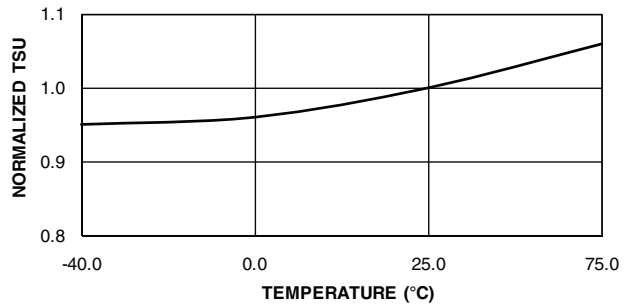

ATMEL ATF22V10C/CQ
NORMALIZED T_{SU} VS. V_{CC}

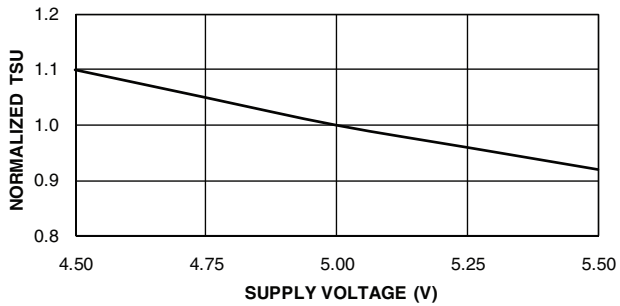

ATMEL ATF22V10C/CQ
DELTA T_{PD} VS. OUTPUT LOADING

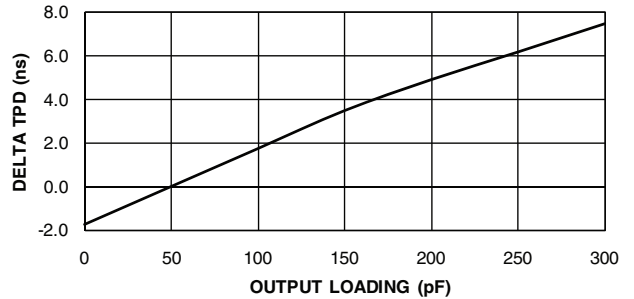

ATMEL ATF22V10C/CQ
NORMALIZED T_{PD} VS. TEMPERATURE

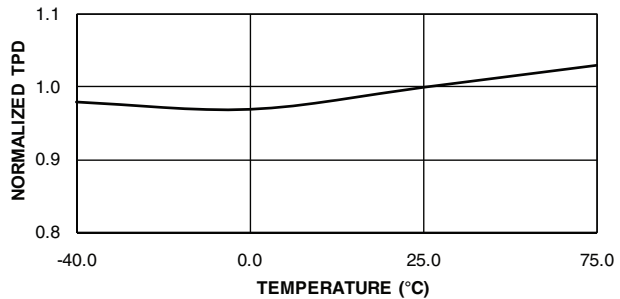

ATMEL ATF22V10C/CQ DELTA T_{PD} VS.
NUMBER OF OUTPUT SWITCHING

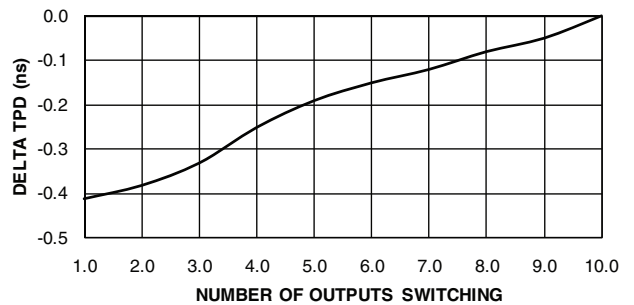

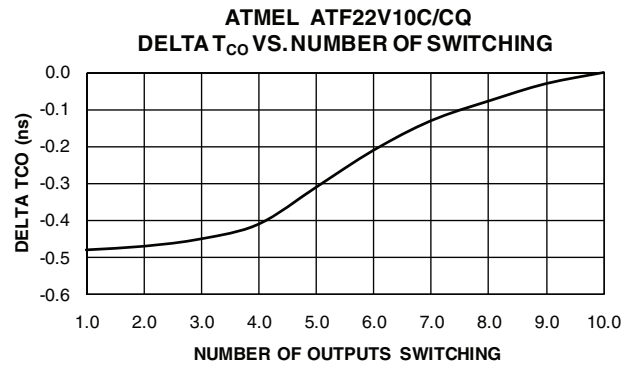
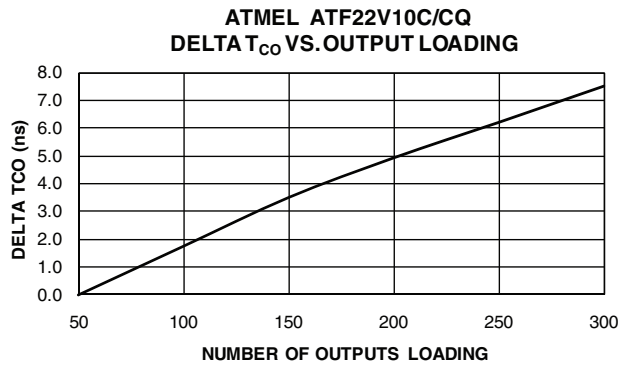

12. Ordering Information

12.1 Atmel ATF22V10C(Q) Green Package Options (Pb/Halide-free/RoHS Compliant)

t _{PD} (ns)	t _S (ns)	t _{CO} (ns)	Ordering Code	Package	Operation Range
5	3	4	ATF22V10C-5JX	28J	Commercial (0°C to 70°C)
7.5	3.5	4.5	ATF22V10C-7PX	24P3	Commercial (0°C to 70°C)
			ATF22V10C-7SX	24S	
7.5	3.5	4.5	ATF22V10C-7JU	28J	Industrial (-40°C to 85°C)
10	4.5	6.5	ATF22V10C-10JU	28J	Industrial (-40°C to 85°C)
			ATF22V10C-10PU	24P3	
			ATF22V10C-10SU	24S	
			ATF22V10C-10XU	24X	
15	10	8	ATF22V10C-15JU	28J	Industrial (-40°C to 85°C)
			ATF22V10C-15PU	24P3	
			ATF22V10CQ-15JU	28J	Industrial (-40°C to 85°C)

12.2 Using “C” Product for Industrial

To use commercial product for industrial temperature ranges, down-grade one speed grade from the industrial-grade to the commercial-grade device (e.g. 7ns PX = 10ns PU) and de-rate power by 30%.

12.3 Military Package Options (Lead-based)⁽¹⁾

t _{PD} (ns)	t _S (ns)	t _{CO} (ns)	Ordering Code	Package	Operation Range
10	4.5	6.5	ATF22V10C-10GM/883	24D3	Military (-55°C to 125°C) Class B, Fully Compliant
			ATF22V10C-10NM/883	28L	
			5962-8984116LA	24D3	
			5962-89841163A	28L	
15	10	8	ATF22V10C-15GM/883	24D3	Military (-55°C to 125°C) Class B, Fully Compliant
			ATF22V10C-15NM/883	28L	
			5962-8984115LA	24D3	
			5962-89841153A	28L	

Notes: 1. Military/DSCC parts meet the DSCC drawing specifications

Package Type	
24D3	24-lead, 0.300" Wide, Non-windowed Ceramic Dual Inline Package (CERDIP)
24P3	24-pin, 0.300" Wide, Plastic Dual Inline Package (PDIP)
24S	24-lead, 0.300" Wide, Plastic Gull Wing Small Outline (SOIC)
24X	24-lead, 4.4mm Wide, Plastic Thin Shrink Small Outline (TSSOP)
28J	28-lead, Plastic J-leaded Chip Carrier (PLCC)
28L	28-lead, Ceramic Leadless Chip Carrier (LCC)

13. Packaging Information

13.1 24D3 – CERDIP

Dimensions in Millimeters and (Inches).
 Controlling dimension: Inches.
 MIL-STD 1835 D-9 Config A (Glass Sealed)

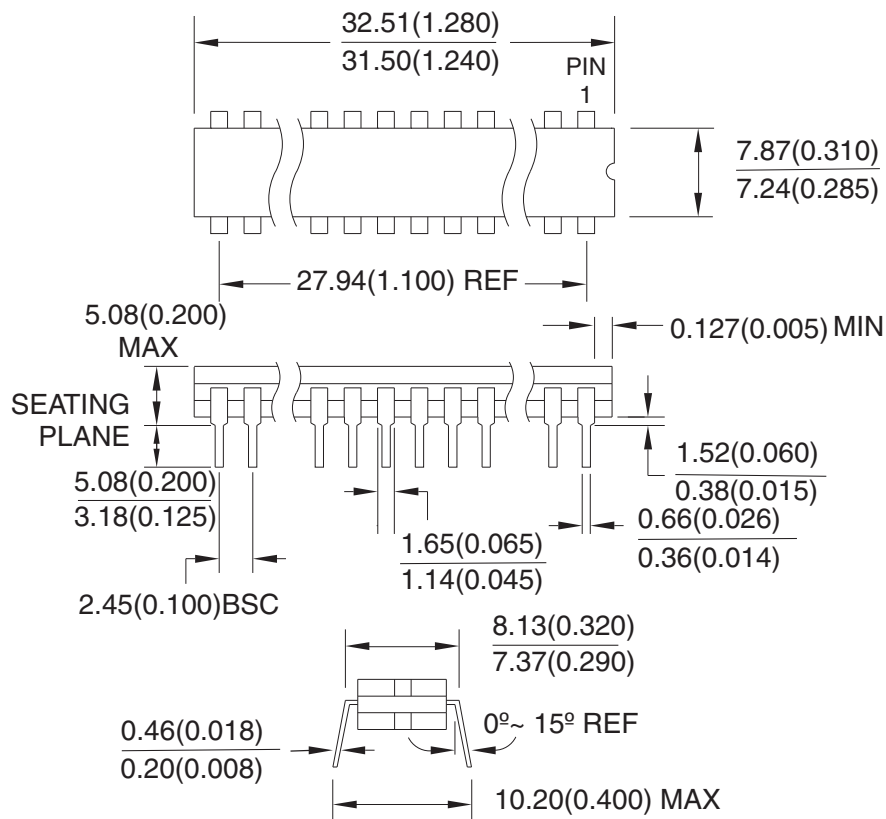

10/21/03

 Package Drawing Contact: packagedrawings@atmel.com	TITLE 24D3, 24-lead, 0.300" Wide. Non-windowed, Ceramic Dual Inline Package (Cerdip)	DRAWING NO. 24D3	REV. B

13.2 24P3 – PDIP

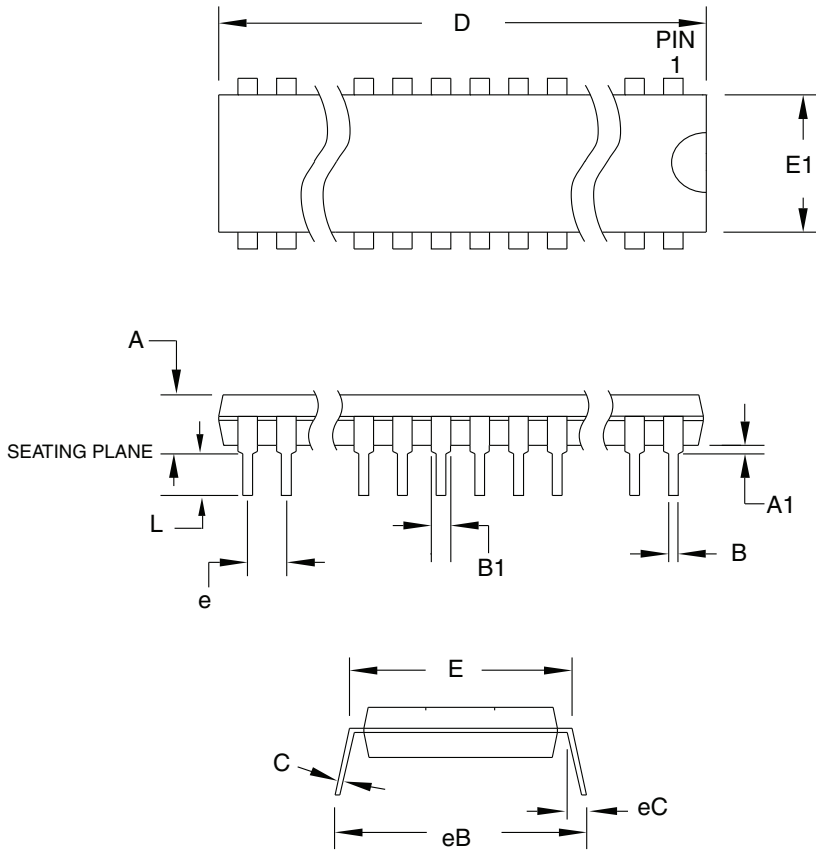

COMMON DIMENSIONS
(Unit of Measure = mm)

SYMBOL	MIN	NOM	MAX	NOTE
A	–	–	5.334	
A1	0.381	–	–	
D	31.623	–	32.131	Note 2
E	7.620	–	8.255	
E1	6.096	–	7.112	Note 2
B	0.356	–	0.559	
B1	1.270	–	1.651	
L	2.921	–	3.810	
C	0.203	–	0.356	
eB	–	–	10.922	
eC	0.000	–	1.524	
e	2.540 TYP			

- Notes:
1. This package conforms to JEDEC reference MS-001, Variation AF
 2. Dimensions D and E1 do not include mold Flash or Protrusion
Mold Flash or Protrusion shall not exceed 0.25mm (0.010")

6/1/04



Package Drawing Contact:
packagedrawings@atmel.com

TITLE
24P3, 24-lead (0.300"/7.62mm Wide) Plastic Dual
Inline Package (PDIP)

DRAWING NO.
24P3

REV.
D

13.3 24S – SOIC

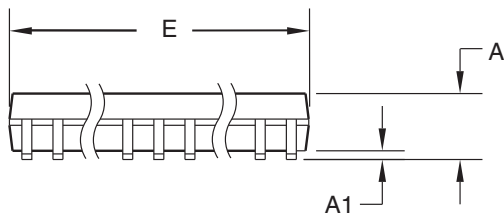
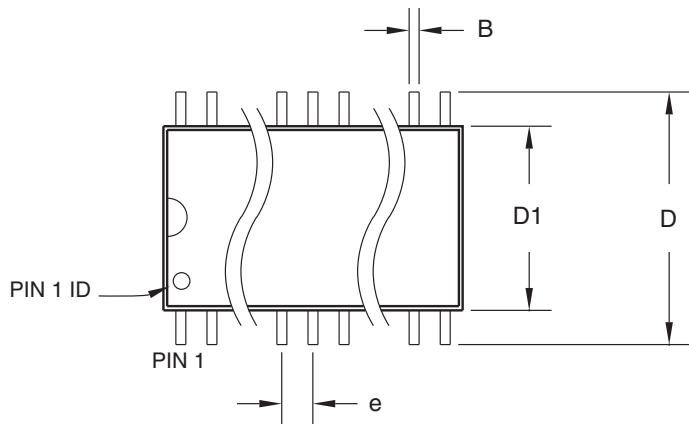

COMMON DIMENSIONS
(Unit of Measure = mm)

SYMBOL	MIN	NOM	MAX	NOTE
A	–	–	2.65	
A1	0.10	–	0.30	
D	10.00	–	10.65	
D1	7.40	–	7.60	
E	15.20	–	15.60	
B	0.33	–	0.51	
L	0.40	–	1.27	
L1	0.23	–	0.32	
e	1.27 BSC			

06/17/2002



Package Drawing Contact:
packagedrawings@atmel.com

TITLE
24S, 24-lead (0.300" body) Plastic Gull Wing Small
Outline (SOIC)

DRAWING NO.

24S

REV.

B



13.4 24X – TSSOP

Dimensions in Millimeter and (Inches)*
 JEDEC STANDARD MO-153 AD
 Controlling dimension: millimeters

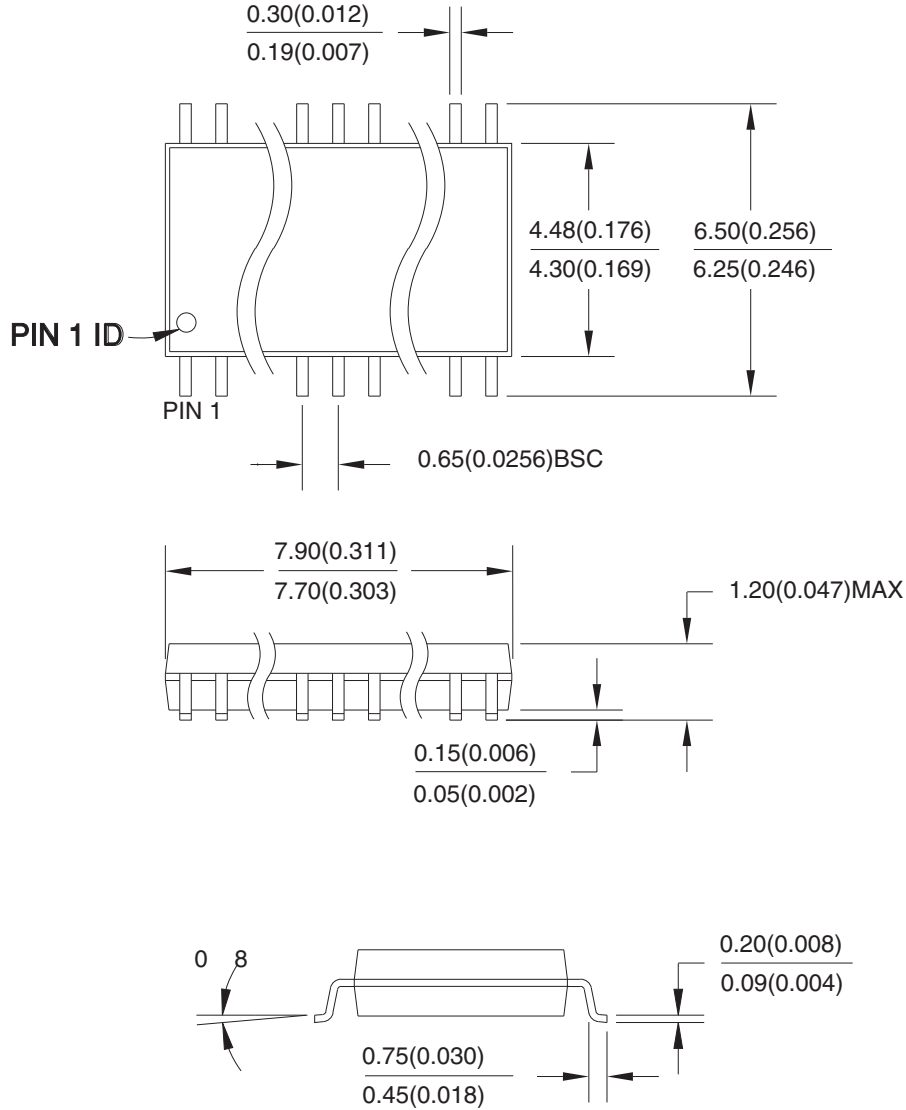

04/11/2001



Package Drawing Contact:
 packagedrawings@atmel.com

TITLE
 24X, 24-lead (4.4mm body width) Plastic Thin Shrink
 Small Outline Package (TSSOP)

DRAWING NO.
 24X

REV.
 A

13.5 28J – PLCC

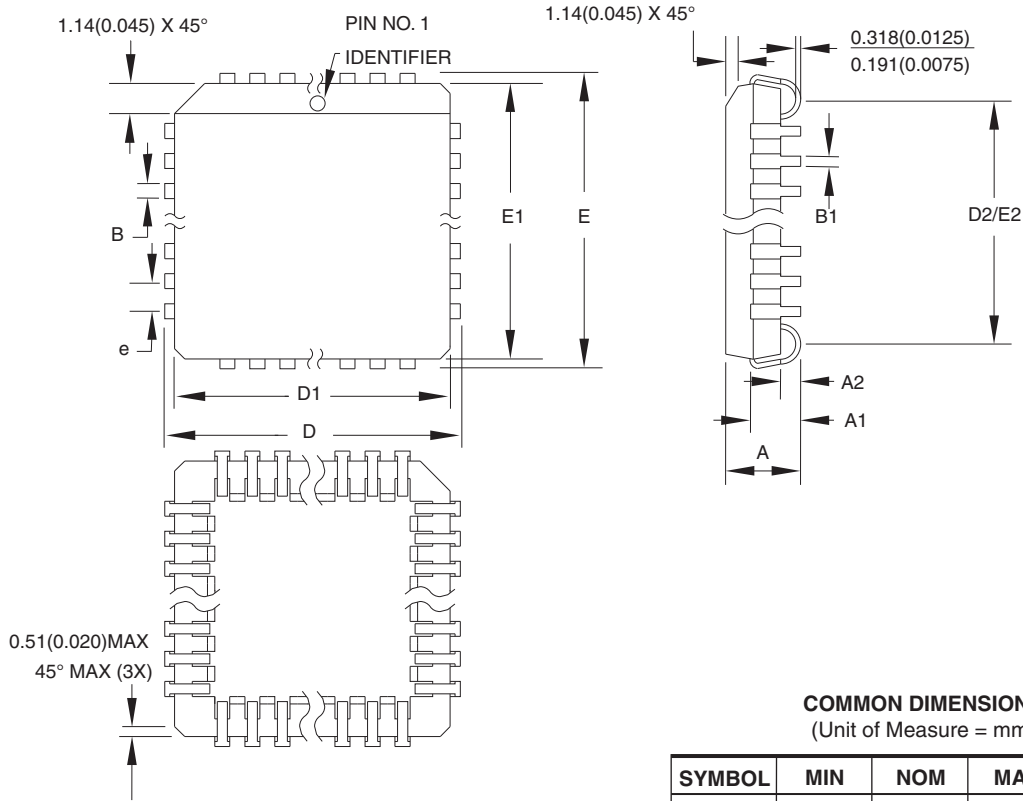

COMMON DIMENSIONS
(Unit of Measure = mm)

SYMBOL	MIN	NOM	MAX	NOTE
A	4.191	–	4.572	
A1	2.286	–	3.048	
A2	0.508	–	–	
D	12.319	–	12.573	
D1	11.430	–	11.582	Note 2
E	12.319	–	12.573	
E1	11.430	–	11.582	Note 2
D2/E2	9.906	–	10.922	
B	0.660	–	0.813	
B1	0.330	–	0.533	
e	1.270 TYP			

- Notes:
1. This package conforms to JEDEC reference MS-018, Variation AB
 2. Dimensions D1 and E1 do not include mold protrusion
Allowable protrusion is .010"(0.254mm) per side. Dimension D1 and E1 include mold mismatch and are measured at the extreme material condition at the upper or lower parting line
 3. Lead coplanarity is 0.004" (0.102mm) maximum

10/04/01



Package Drawing Contact:
packagedrawings@atmel.com

TITLE

28J, 28-lead, Plastic J-leaded Chip Carrier (PLCC)

DRAWING NO.

28J

REV.

B



13.6 28L – LCC

Dimensions in Millimeters and (Inches).
 Controlling dimension: Inches.
 MIL-STD 1835 C-4

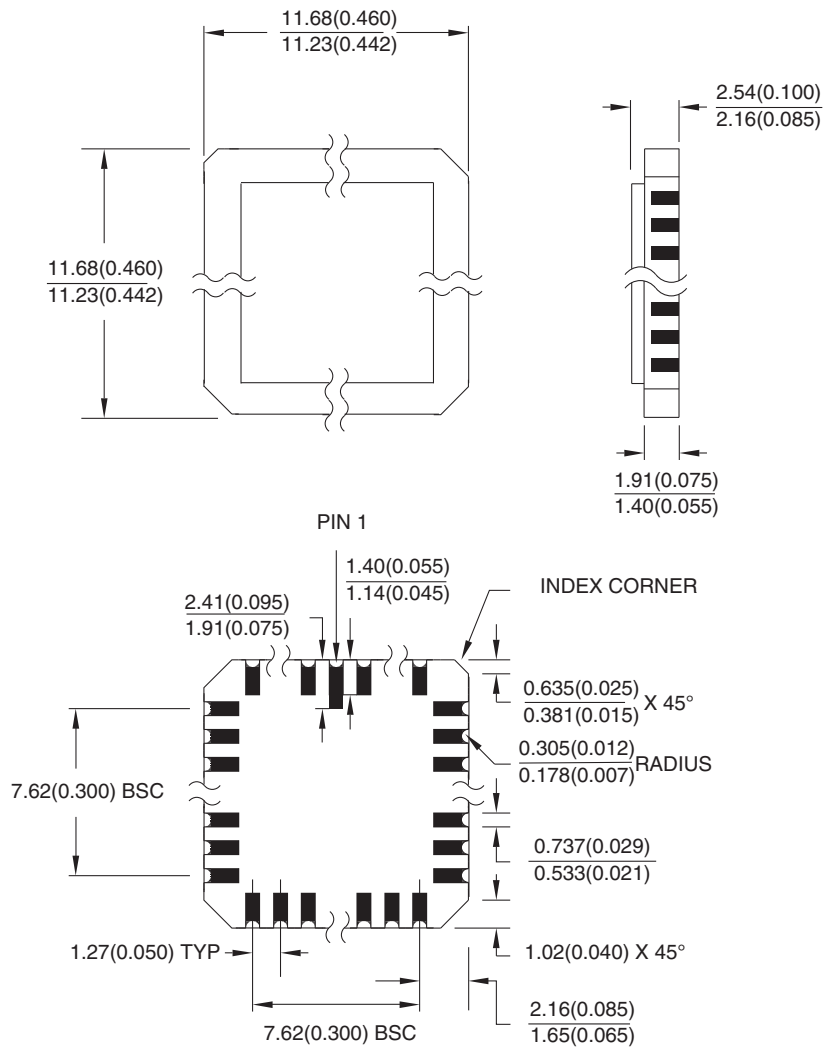

10/21/03

	Package Drawing Contact: packagedrawings@atmel.com	TITLE 28L, 28-pad, Non-windowed, Ceramic Lid, Leadless Chip Carrier (LCC)	DRAWING NO. 28L	REV. B
--	--	---	---------------------------	------------------

14. Revision History

Doc. Rev.	Date	Comments
0735U	05/2010	Updated C-15 military device I_{CC} limit Revised the maximum power supply current in PD mode for commercial- and industrial-grade devices from 100 μ A to 500 μ A and 100 μ A to 650 μ A maximum, respectively C-15 and CQ-15 Commercial part removed from Table 4-1 . Removed Mil from I_{CC} , C-15 (Ind.) parts I_{CC2} at 15mhz Max changed from 90mA to 125mA
0735T	05/2009	Added military-grade packages and removed leaded parts
0735S	08/2008	Added new green part
0735R	06/2008	Updated Green package options



Headquarters

Atmel Corporation

2325 Orchard Parkway
San Jose, CA 95131
USA
Tel: (+1) (408) 441-0311
Fax: (+1) (408) 487-2600
www.atmel.com

International

Atmel Asia Limited

Unit 01-5 & 16, 19F
BEA Tower, Millennium City 5
418 Kwun Tong Road
Kwun Tong, Kowloon
HONG KONG
Tel: (+852) 2245-6100
Fax: (+852) 2722-1369

Atmel Munich GmbH

Business Campus
Parkring 4
D-85748 Garching b. Munich
GERMANY
Tel: (+49) 89-31970-0
Fax: (+49) 89-3194621

Atmel Japan

9F, Tonetsu Shinkawa Bldg.
1-24-8 Shinkawa
Chuo-ku, Tokyo 104-0033
JAPAN
Tel: (+81) (3) 3523-3551
Fax: (+81) (3) 3523-7581

Product Contacts

Technical Support

PLD@atmel.com

Sales Contact

www.atmel.com/contacts

Literature Requests

www.atmel.com/literature

Disclaimer: The information in this document is provided in connection with Atmel products. No license, express or implied, by estoppel or otherwise, to any intellectual property right is granted by this document or in connection with the sale of Atmel products. **EXCEPT AS SET FORTH IN ATMEL'S TERMS AND CONDITIONS OF SALE LOCATED ON ATMEL'S WEB SITE, ATMEL ASSUMES NO LIABILITY WHATSOEVER AND DISCLAIMS ANY EXPRESS, IMPLIED OR STATUTORY WARRANTY RELATING TO ITS PRODUCTS INCLUDING, BUT NOT LIMITED TO, THE IMPLIED WARRANTY OF MERCHANTABILITY, FITNESS FOR A PARTICULAR PURPOSE, OR NON-INFRINGEMENT. IN NO EVENT SHALL ATMEL BE LIABLE FOR ANY DIRECT, INDIRECT, CONSEQUENTIAL, PUNITIVE, SPECIAL OR INCIDENTAL DAMAGES (INCLUDING, WITHOUT LIMITATION, DAMAGES FOR LOSS OF PROFITS, BUSINESS INTERRUPTION, OR LOSS OF INFORMATION) ARISING OUT OF THE USE OR INABILITY TO USE THIS DOCUMENT, EVEN IF ATMEL HAS BEEN ADVISED OF THE POSSIBILITY OF SUCH DAMAGES.** Atmel makes no representations or warranties with respect to the accuracy or completeness of the contents of this document and reserves the right to make changes to specifications and product descriptions at any time without notice. Atmel does not make any commitment to update the information contained herein. Unless specifically provided otherwise, Atmel products are not suitable for, and shall not be used in, automotive applications. Atmel's products are not intended, authorized, or warranted for use as components in applications intended to support or sustain life.

© 2010 Atmel Corporation. All rights reserved.

Atmel®, logo and combinations thereof, and others are registered trademarks or trademarks of Atmel Corporation or its subsidiaries. Other terms and product names may be trademarks of others.