

FEATURES

Fixed gain of 20 dB
Operation from 50 MHz to 4.0 GHz
Highest dynamic range gain block
Input/output internally matched to 50 Ω
Integrated bias control circuit
OIP3 of 42.0 dBm at 2.0 GHz
P1dB of 19.3 dBm at 2.0 GHz
Noise figure of 3.3 dB at 2.0 GHz
Single 5 V power supply
Low quiescent current of 89 mA
Thermally efficient SOT-89 package
ESD rating of ± 1.5 kV (Class 1C)

GENERAL DESCRIPTION

The [ADL5602](#) is a broadband 20 dB linear amplifier that operates at frequencies up to 4 GHz. The device can be used in a wide variety of cellular, CATV, military, and instrumentation equipment.

The [ADL5602](#) provides the highest dynamic range available from an internally matched gain block. This is accomplished by providing extremely low noise figures and very high OIP3 specifications simultaneously, across the entire 4 GHz frequency range.

The [ADL5602](#) provides a gain of 20 dB, which is stable over frequency, temperature, power supply, and from device to device. The device is internally matched to 50 Ω at the input and output, making the [ADL5602](#) very easy to implement in a wide variety of applications. Only input/output ac coupling capacitors, power supply decoupling capacitors, and an external inductor are required for operation.

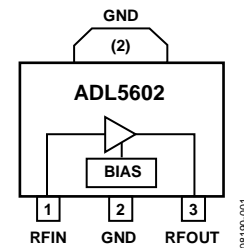
FUNCTIONAL BLOCK DIAGRAM*Figure 1.*

The [ADL5602](#) is fabricated on an InGaP HBT process and has an ESD rating of ± 1.5 kV (Class 1C). The device is available in a thermally efficient SOT-89 package.

The [ADL5602](#) consumes 89 mA on a single 5 V supply and is fully specified for operation from -40°C to $+85^{\circ}\text{C}$.

A fully populated RoHS-compliant evaluation board is available.

TABLE OF CONTENTS

Features	1	Basic Connections	12
Functional Block Diagram	1	Soldering Information and Recommended	
General Description	1	PCB Land Pattern.....	12
Revision History	2	W-CDMA ACPR Performance	13
Specifications.....	3	Evaluation Board	14
Typical Scattering Parameters (S Parameters).....	5	Outline Dimensions	15
Absolute Maximum Ratings.....	7	Ordering Guide	15
ESD Caution.....	7		
Pin Configuration and Function Descriptions.....	8		
Typical Performance Characteristics	9		

REVISION HISTORY

11/13—Rev. 0 to Rev. A

Changes to Figure 2.....	8
Added Figure 15, Renumbered Sequentially	11
Changes to Figure 17.....	12
Updated Outline Dimensions	15

6/09—Revision 0: Initial Version

SPECIFICATIONS

$V_{CC} = 5\text{ V}$ and $T_A = 25^\circ\text{C}$, unless otherwise noted.

Table 1.

Parameter	Conditions	Min	Typ	Max	Unit
OVERALL FUNCTION					
Frequency Range		50		4000	MHz
FREQUENCY = 50 MHz					
Gain			18.3		dB
Output 1 dB Compression Point (P1dB)			18.0		dBm
Output Third-Order Intercept (OIP3)	$\Delta f = 1\text{ MHz}$, output power (P_{OUT}) = 0 dBm per tone		27.5		dBm
Second Harmonic	$P_{OUT} = 0\text{ dBm}$		-40.5		dBc
Third Harmonic	$P_{OUT} = 0\text{ dBm}$		-46.1		dBc
Noise Figure			2.9		dB
FREQUENCY = 140 MHz					
Gain			17.0		dB
vs. Frequency	$\pm 50\text{ MHz}$		± 1.2		dB
vs. Temperature	$-40^\circ\text{C} \leq T_A \leq +85^\circ\text{C}$		± 0.03		dB
vs. Supply Voltage	4.75 V to 5.25 V		± 0.04		dB
Output 1 dB Compression Point (P1dB)			18.3		dBm
Output Third-Order Intercept (OIP3)	$\Delta f = 1\text{ MHz}$, output power (P_{OUT}) = 0 dBm per tone		25.0		dBm
Second Harmonic	$P_{OUT} = 0\text{ dBm}$		-45.1		dBc
Third Harmonic	$P_{OUT} = 0\text{ dBm}$		-55.1		dBc
Noise Figure			2.9		dB
FREQUENCY = 350 MHz					
Gain			19.7		dB
vs. Frequency	$\pm 50\text{ MHz}$		± 0.20		dB
vs. Temperature	$-40^\circ\text{C} \leq T_A \leq +85^\circ\text{C}$		± 0.31		dB
vs. Supply Voltage	4.75 V to 5.25 V		± 0.01		dB
Output 1 dB Compression Point (P1dB)			20.0		dBm
Output Third-Order Intercept (OIP3)	$\Delta f = 1\text{ MHz}$, output power (P_{OUT}) = 0 dBm per tone		36.5		dBm
Second Harmonic	$P_{OUT} = 0\text{ dBm}$		-49.9		dBc
Third Harmonic	$P_{OUT} = 0\text{ dBm}$		-83.7		dBc
Noise Figure			3.0		dB
FREQUENCY = 700 MHz					
Gain		19.0	20.2	21.0	dB
vs. Frequency	$\pm 50\text{ MHz}$		± 0.01		dB
vs. Temperature	$-40^\circ\text{C} \leq T_A \leq +85^\circ\text{C}$		± 0.28		dB
vs. Supply Voltage	4.75 V to 5.25 V		± 0.01		dB
Output 1 dB Compression Point (P1dB)		19.0	20.1		dBm
Output Third-Order Intercept (OIP3)	$\Delta f = 1\text{ MHz}$, output power (P_{OUT}) = 0 dBm per tone		38.5		dBm
Second Harmonic	$P_{OUT} = 0\text{ dBm}$		-50.3		dBc
Third Harmonic	$P_{OUT} = 0\text{ dBm}$		-78.4		dBc
Noise Figure			3.0		dB

Parameter	Conditions	Min	Typ	Max	Unit
FREQUENCY = 900 MHz					
Gain		19.0	20.2	21.0	dB
vs. Frequency	±50 MHz		±0.01		dB
vs. Temperature	−40°C ≤ T _A ≤ +85°C		±0.28		dB
vs. Supply Voltage	4.75 V to 5.25 V		±0.01		dB
Output 1 dB Compression Point (P1dB)		19.0	20.1		dBm
Output Third-Order Intercept (OIP3)	Δf = 1 MHz, output power (P _{OUT}) = 0 dBm per tone		40.0		dBm
Second Harmonic	P _{OUT} = 0 dBm		−59.4		dBc
Third Harmonic	P _{OUT} = 0 dBm		−77.3		dBc
Noise Figure			2.9		dB
FREQUENCY = 2000 MHz					
Gain			19.5		dB
vs. Frequency	±50 MHz		±0.04		dB
vs. Temperature	−40°C ≤ T _A ≤ +85°C		±0.35		dB
vs. Supply Voltage	4.75 V to 5.25 V		±0.04		dB
Output 1 dB Compression Point (P1dB)			19.3		dBm
Output Third-Order Intercept (OIP3)	Δf = 1 MHz, output power (P _{OUT}) = 0 dBm per tone		42.0		dBm
Second Harmonic	P _{OUT} = 0 dBm		−53.1		dBc
Third Harmonic	P _{OUT} = 0 dBm		−60.7		dBc
Noise Figure			3.3		dB
FREQUENCY = 2600 MHz					
Gain			19.2		dB
vs. Frequency	±50 MHz		±0.01		dB
vs. Temperature	−40°C ≤ T _A ≤ +85°C		±0.28		dB
vs. Supply Voltage	4.75 V to 5.25 V		±0.05		dB
Output 1 dB Compression Point (P1dB)			18.7		dBm
Output Third-Order Intercept (OIP3)	Δf = 1 MHz, output power (P _{OUT}) = 0 dBm per tone		36.5		dBm
Second Harmonic	P _{OUT} = 0 dBm		−52.8		dBc
Third Harmonic	P _{OUT} = 0 dBm		−67.4		dBc
Noise Figure			3.4		dB
FREQUENCY = 3500 MHz					
Gain			19.3		dB
vs. Frequency	±50 MHz		±0.03		dB
vs. Temperature	−40°C ≤ T _A ≤ +85°C		±0.37		dB
vs. Supply Voltage	4.75 V to 5.25 V		±0.07		dB
Output 1 dB Compression Point (P1dB)			17.4		dBm
Output Third-Order Intercept (OIP3)	Δf = 1 MHz, output power (P _{OUT}) = 0 dBm per tone		31.5		dBm
Second Harmonic	P _{OUT} = 0 dBm		−42.9		dBc
Third Harmonic	P _{OUT} = 0 dBm		−66.4		dBc
Noise Figure			3.8		dB
FREQUENCY = 4000 MHz					
Gain			18.5		dB
vs. Frequency	±50 MHz		±0.19		dB
vs. Temperature	−40°C ≤ T _A ≤ +85°C		±0.73		dB
vs. Supply Voltage	4.75 V to 5.25 V		±0.08		dB
Output 1 dB Compression Point (P1dB)			15.2		dBm
Output Third-Order Intercept (OIP3)	Δf = 1 MHz, output power (P _{OUT}) = 0 dBm per tone		28.0		dBm
Second Harmonic	P _{OUT} = 0 dBm		−44.1		dBc
Third Harmonic	P _{OUT} = 0 dBm		−64.0		dBc
Noise Figure			4.2		dB

Parameter	Conditions	Min	Typ	Max	Unit
POWER INTERFACE	VCC	4.5	5	5.5	V
Supply Voltage (V _{CC})			89	106	mA
Supply Current vs. Temperature	-40°C ≤ T _A ≤ +85°C		±3		mA
Power Dissipation	V _{CC} = 5 V		0.45		W

TYPICAL SCATTERING PARAMETERS (S PARAMETERS)

V_{CC} = 5 V and T_A = 25°C, the effects of the test fixture have been de-embedded up to the pins of the device.

Table 2.

Frequency (MHz)	S11		S21		S12		S22	
	Magnitude (dB)	Angle (°)	Magnitude (dB)	Angle (°)	Magnitude (dB)	Angle (°)	Magnitude (dB)	Angle (°)
50	-12.75	+32.81	18.14	+163.00	-25.27	-9.54	-8.96	-145.86
100	-8.98	-7.00	15.77	-179.92	-27.59	+4.56	-7.07	-178.96
150	-10.11	-34.04	17.27	-169.01	-26.11	+16.05	-7.89	+159.89
200	-11.97	-50.46	18.50	-168.73	-24.84	+16.55	-9.33	+147.22
250	-13.85	-62.42	19.21	-171.01	-24.14	+14.79	-10.87	+140.02
300	-15.69	-72.90	19.64	-173.77	-23.70	+12.89	-12.23	+136.16
350	-17.40	-81.30	19.90	-176.45	-23.43	+11.02	-13.56	+134.03
400	-19.17	-88.48	20.07	-178.86	-23.26	+9.65	-14.79	+132.79
450	-20.86	-97.45	20.18	+178.79	-23.14	+8.07	-15.99	+132.72
500	-22.52	-107.32	20.25	+176.86	-23.08	+7.11	-17.02	+133.33
550	-24.32	-112.89	20.32	+174.84	-23.00	+6.15	-18.21	+133.04
600	-26.07	-120.03	20.35	+173.09	-22.97	+5.24	-19.45	+135.06
650	-27.89	-128.79	20.39	+171.35	-22.93	+4.35	-20.73	+136.29
700	-30.79	-133.19	20.42	+169.67	-22.91	+3.72	-22.22	+136.96
750	-34.53	-136.03	20.42	+167.93	-22.91	+2.93	-23.91	+135.39
800	-42.59	-130.76	20.46	+166.48	-22.88	+2.30	-26.35	+136.07
850	-46.49	-2.93	20.47	+164.85	-22.88	+1.67	-29.40	+132.08
900	-34.26	+15.99	20.47	+163.17	-22.86	+0.98	-34.27	+116.48
950	-29.55	+9.83	20.48	+161.77	-22.86	+0.39	-40.86	+41.72
1000	-25.87	+5.52	20.48	+160.25	-22.86	-0.21	-31.44	-10.36
1050	-23.03	+1.85	20.47	+158.65	-22.89	-0.84	-26.19	-18.99
1100	-21.25	+0.10	20.45	+157.18	-22.90	-1.43	-23.27	-22.34
1150	-19.31	-1.89	20.45	+155.50	-22.92	-2.06	-20.70	-22.26
1200	-17.72	-4.09	20.40	+153.93	-22.96	-2.72	-18.67	-24.44
1250	-16.13	-6.53	20.35	+152.44	-23.04	-3.38	-16.92	-24.75
1300	-14.81	-8.71	20.31	+150.88	-23.07	-4.04	-15.44	-25.79
1350	-13.65	-10.01	20.24	+149.35	-23.16	-4.60	-14.14	-25.36
1400	-12.68	-11.33	20.18	+147.91	-23.22	-5.06	-13.12	-25.73
1450	-11.72	-12.65	20.11	+146.40	-23.32	-5.76	-12.04	-25.59
1500	-10.92	-13.56	20.04	+145.13	-23.39	-6.16	-11.20	-25.40
1550	-10.21	-14.37	19.97	+143.86	-23.49	-6.54	-10.49	-25.60
1600	-9.58	-15.37	19.88	+142.58	-23.57	-6.93	-9.77	-25.59
1650	-9.05	-15.74	19.80	+141.40	-23.69	-7.16	-9.21	-25.31
1700	-8.52	-16.73	19.72	+140.23	-23.76	-7.45	-8.66	-25.42
1750	-8.13	-17.13	19.64	+139.13	-23.87	-7.60	-8.26	-25.32
1800	-7.76	-17.59	19.57	+138.12	-23.94	-7.80	-7.91	-24.96
1850	-7.46	-17.76	19.50	+137.16	-24.05	-7.88	-7.56	-24.77
1900	-7.19	-17.92	19.43	+136.25	-24.13	-7.91	-7.35	-24.46
1950	-6.98	-17.84	19.39	+135.31	-24.18	-7.94	-7.13	-23.92

Frequency (MHz)	S11		S21		S12		S22	
	Magnitude (dB)	Angle (°)	Magnitude (dB)	Angle (°)	Magnitude (dB)	Angle (°)	Magnitude (dB)	Angle (°)
2000	-6.85	-18.00	19.35	+134.44	-24.26	-7.99	-6.96	-23.55
2050	-6.74	-17.93	19.31	+133.61	-24.29	-7.91	-6.86	-22.70
2100	-6.63	-17.57	19.29	+132.74	-24.37	-7.81	-6.75	-22.45
2150	-6.66	-17.34	19.25	+132.06	-24.42	-7.58	-6.76	-22.01
2200	-6.65	-17.26	19.29	+131.19	-24.40	-7.63	-6.78	-21.42
2250	-6.69	-17.10	19.30	+130.47	-24.41	-7.59	-6.82	-20.82
2300	-6.77	-16.90	19.33	+129.54	-24.42	-7.40	-6.87	-20.25
2350	-6.87	-16.65	19.36	+128.72	-24.40	-7.46	-7.04	-19.57
2400	-7.05	-16.25	19.42	+127.81	-24.38	-7.50	-7.20	-18.85
2450	-7.22	-16.11	19.49	+126.89	-24.35	-7.46	-7.42	-18.17
2500	-7.45	-16.00	19.53	+125.82	-24.31	-7.75	-7.66	-17.76
2550	-7.64	-15.84	19.58	+124.74	-24.31	-7.86	-7.91	-17.18
2600	-7.95	-15.66	19.66	+123.61	-24.25	-8.20	-8.29	-16.64
2650	-8.29	-15.64	19.74	+122.46	-24.19	-8.54	-8.66	-16.15
2700	-8.62	-15.95	19.81	+121.20	-24.17	-8.90	-8.97	-15.97
2750	-8.95	-15.92	19.89	+119.91	-24.13	-9.35	-9.41	-15.67
2800	-9.31	-16.23	19.94	+118.47	-24.08	-9.95	-9.87	-15.96
2850	-9.67	-16.74	20.03	+117.02	-24.05	-10.55	-10.34	-16.17
2900	-9.99	-17.33	20.07	+115.47	-24.07	-11.17	-10.83	-16.68
2950	-10.28	-18.00	20.14	+113.95	-24.02	-11.71	-11.28	-17.66
3000	-10.53	-19.16	20.18	+112.28	-24.03	-12.51	-11.69	-19.15
3050	-10.69	-20.29	20.21	+110.53	-24.10	-13.72	-12.17	-21.42
3100	-10.86	-21.94	20.25	+108.77	-24.04	-14.66	-12.54	-24.24
3150	-10.91	-23.61	20.27	+107.15	-24.09	-15.23	-12.83	-27.07
3200	-10.70	-25.42	20.28	+105.16	-24.18	-16.23	-12.92	-32.00
3250	-10.57	-27.33	20.28	+103.09	-24.17	-17.39	-13.04	-36.71
3300	-10.38	-29.60	20.26	+101.20	-24.22	-18.24	-12.99	-42.66
3350	-9.92	-31.76	20.21	+99.05	-24.39	-20.06	-12.57	-48.16
3400	-9.48	-34.25	20.15	+96.98	-24.49	-20.74	-12.19	-54.36
3450	-8.98	-36.47	20.08	+94.93	-24.61	-21.69	-11.64	-59.44
3500	-8.44	-38.18	20.00	+92.80	-24.72	-23.44	-11.00	-64.07
3550	-7.92	-40.32	19.90	+90.88	-24.88	-24.35	-10.34	-68.43
3600	-7.34	-42.20	19.74	+88.69	-25.15	-25.31	-9.59	-72.77
3650	-6.79	-43.72	19.57	+86.66	-25.35	-26.95	-8.90	-76.09
3700	-6.29	-45.15	19.41	+84.80	-25.56	-27.76	-8.29	-79.17
3750	-5.82	-46.51	19.23	+82.83	-25.90	-28.90	-7.69	-81.76
3800	-5.37	-47.51	19.00	+81.05	-26.16	-29.05	-7.12	-84.30
3850	-4.93	-48.36	18.78	+79.53	-26.46	-30.35	-6.65	-86.42
3900	-4.56	-48.94	18.55	+78.02	-26.81	-29.93	-6.20	-88.14
3950	-4.23	-49.33	18.32	+76.71	-27.08	-31.04	-5.83	-89.69
4000	-3.97	-49.71	18.08	+75.39	-27.50	-30.65	-5.50	-91.14

ABSOLUTE MAXIMUM RATINGS

Table 3.

Parameter	Rating
Supply Voltage, V_{CC}	6.5 V
Input Power (re: 50 Ω)	16 dBm
Internal Power Dissipation (Paddle Soldered)	600 mW
θ_{JA} (Junction to Air)	30.7°C/W
θ_{JC} (Junction to Paddle)	5.0°C/W
Maximum Junction Temperature	150°C
Lead Temperature (Soldering, 60 sec)	240°C
Operating Temperature Range	-40°C to +85°C
Storage Temperature Range	-65°C to +150°C

Stresses above those listed under Absolute Maximum Ratings may cause permanent damage to the device. This is a stress rating only; functional operation of the device at these or any other conditions above those indicated in the operational section of this specification is not implied. Exposure to absolute maximum rating conditions for extended periods may affect device reliability.

ESD CAUTION



ESD (electrostatic discharge) sensitive device. Charged devices and circuit boards can discharge without detection. Although this product features patented or proprietary protection circuitry, damage may occur on devices subjected to high energy ESD. Therefore, proper ESD precautions should be taken to avoid performance degradation or loss of functionality.

PIN CONFIGURATION AND FUNCTION DESCRIPTIONS

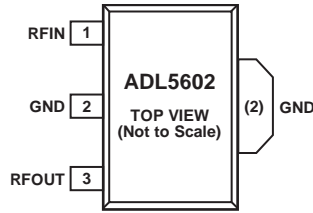

NOTES
 1. EXPOSED PADDLE, INTERNALLY CONNECTED TO GND. SOLDER TO A LOW IMPEDANCE GROUND PLANE.

08150-002

Figure 2. Pin Configuration

Table 4. Pin Function Descriptions

Pin No.	Mnemonic	Description
1	RFIN	RF Input. This pin requires a dc blocking capacitor.
2	GND	Ground. Connect this pin to a low impedance ground plane.
3	RFOUT	RF Output and Supply Voltage. DC bias is provided to this pin through an inductor that is connected to the external power supply. The RF path requires a dc blocking capacitor.
(2)	Exposed Paddle	Exposed Paddle. Internally connected to GND. Solder to a low impedance ground plane.

TYPICAL PERFORMANCE CHARACTERISTICS

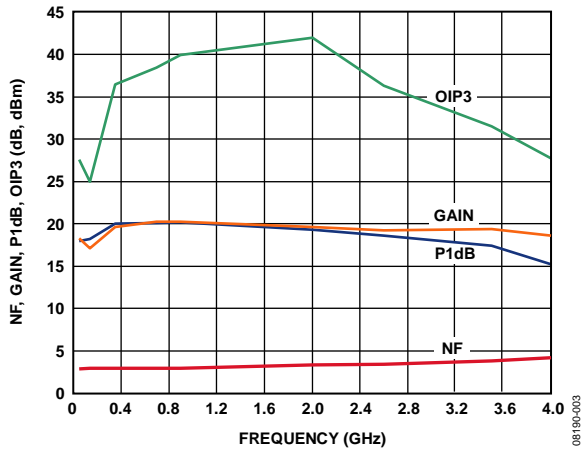

Figure 3. Noise Figure, Gain, P1dB, and OIP3 vs. Frequency

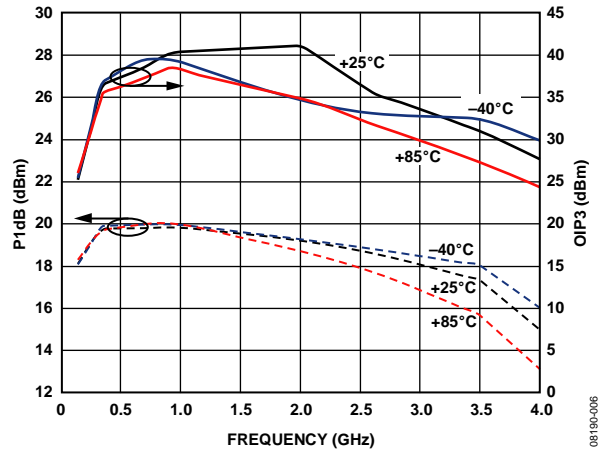

Figure 6. P1dB and OIP3 vs. Frequency and Temperature

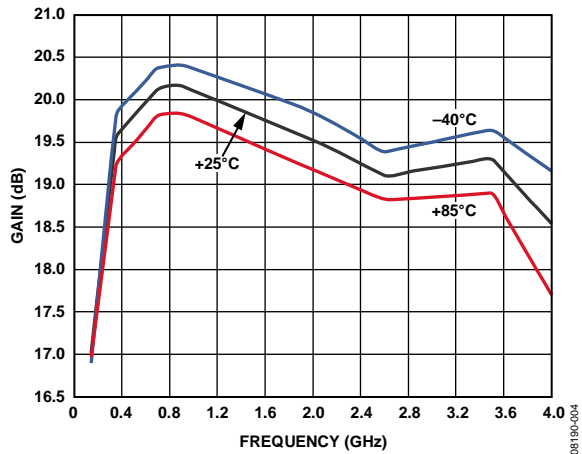

Figure 4. Gain vs. Frequency and Temperature

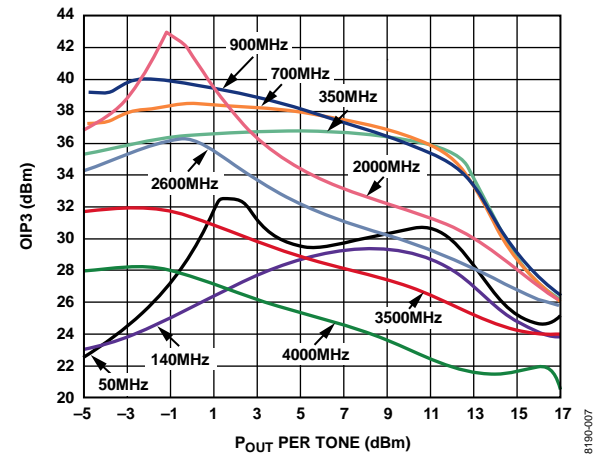

Figure 7. OIP3 vs. Output Power (P_{OUT}) and Frequency

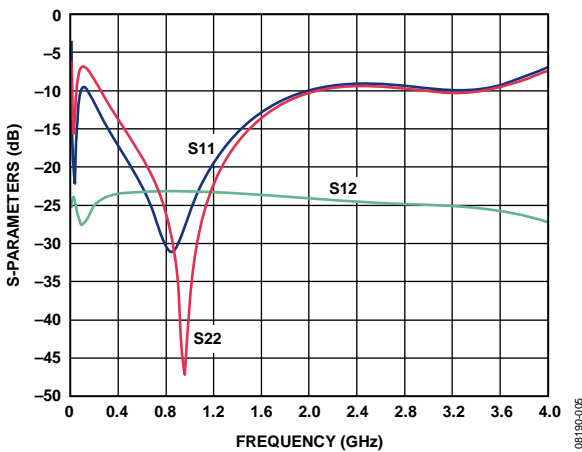

Figure 5. Input Return Loss (S11), Output Return Loss (S22), and Reverse Isolation (S12) vs. Frequency

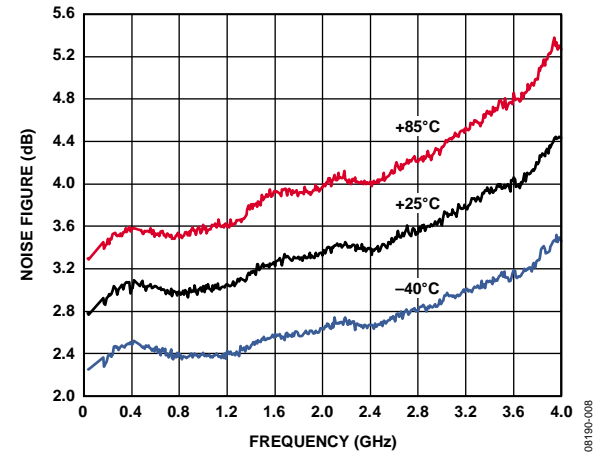

Figure 8. Noise Figure vs. Frequency and Temperature

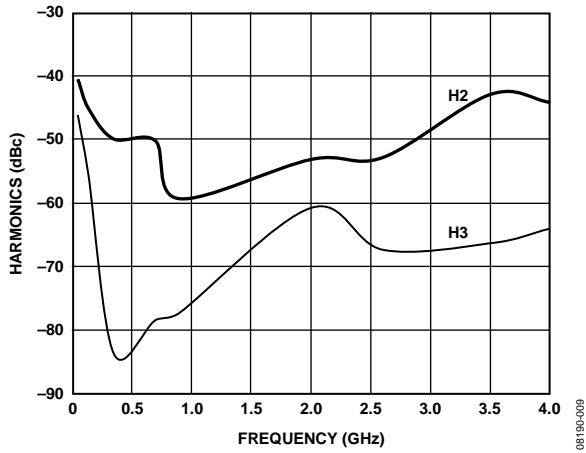

Figure 9. Single Tone Harmonics vs. Frequency, $P_{OUT} = 0$ dBm

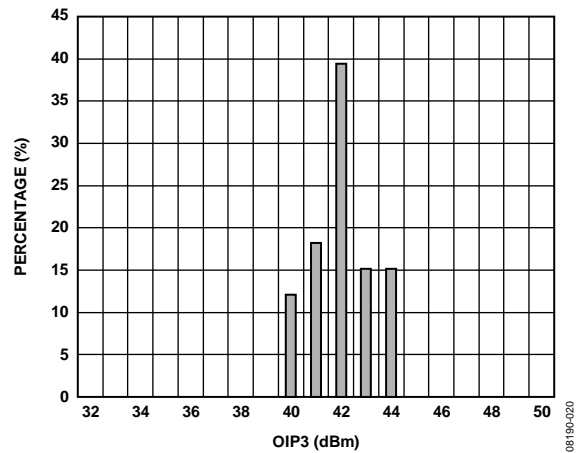

Figure 12. OIP3 Distribution at 2000 MHz, $P_{OUT} = 0$ dBm

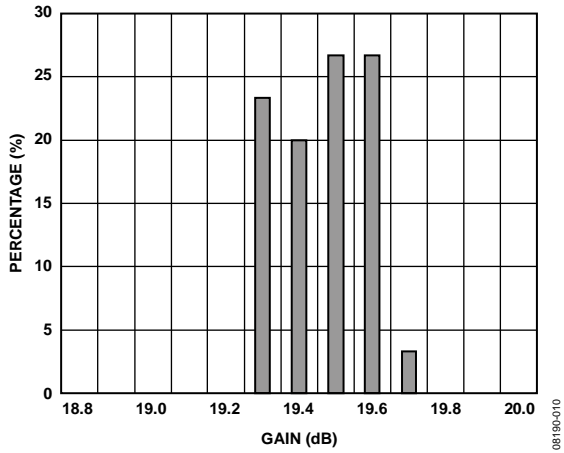

Figure 10. Gain Distribution at 2000 MHz

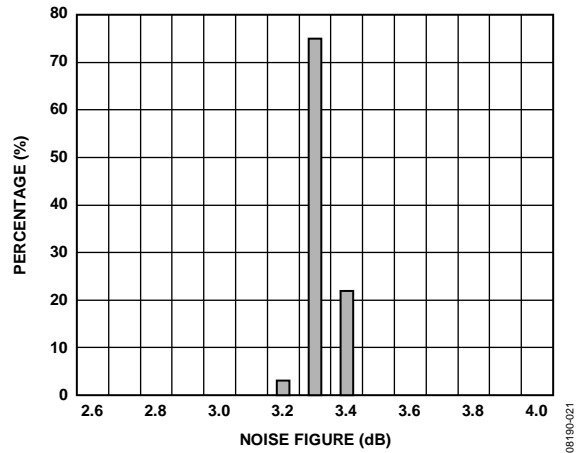

Figure 13. Noise Figure Distribution at 2000 MHz

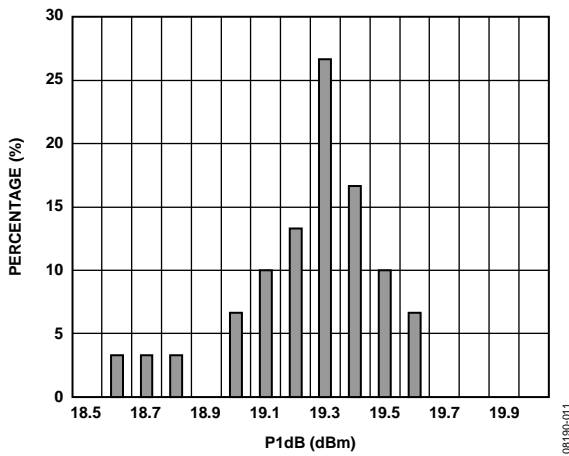

Figure 11. P1dB Distribution at 2000 MHz

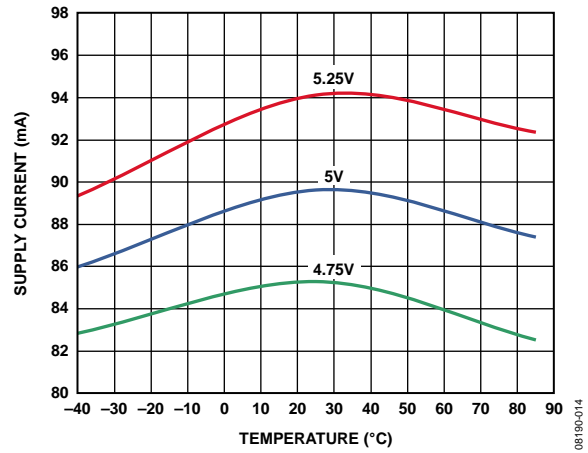

Figure 14. Supply Current vs. Temperature

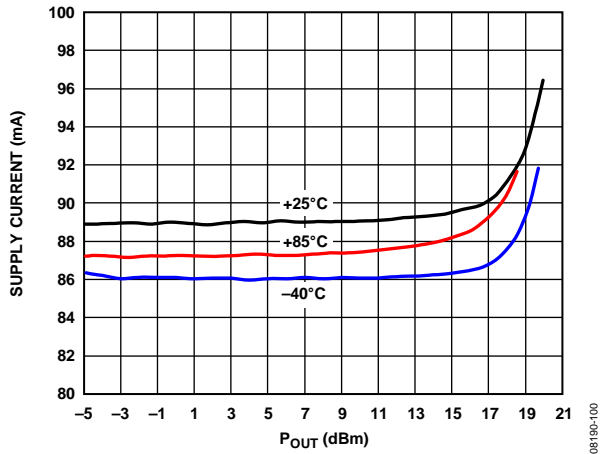

Figure 15. Supply Current vs. P_{OUT} and Temperature V_{CC} = 5 V

08190-100

BASIC CONNECTIONS

The basic connections for operating the ADL5602 are shown in Figure 16. Recommended components are listed in Table 5. The input and output should be ac-coupled with appropriately sized capacitors (device characterization was performed with 0.1 μ F capacitors). A 5 V dc bias is supplied to the amplifier through the bias inductor connected to RFOUT (Pin 3). The bias voltage should be decoupled using a 1 μ F capacitor, a 1.2 nF capacitor, and a 68 pF capacitor.

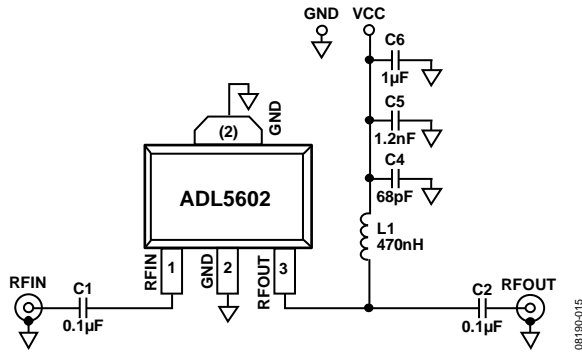

Figure 16. Basic Connections

SOLDERING INFORMATION AND RECOMMENDED PCB LAND PATTERN

Figure 17 shows the recommended land pattern for the ADL5602. To minimize thermal impedance, the exposed paddle on the package underside should be soldered down to a ground plane along with Pin 2. If multiple ground layers exist, they should be stitched together using vias. For more information on land pattern design and layout, refer to the AN-772 Application Note, A Design and Manufacturing Guide for the Lead Frame Chip Scale Package (LFCSP).

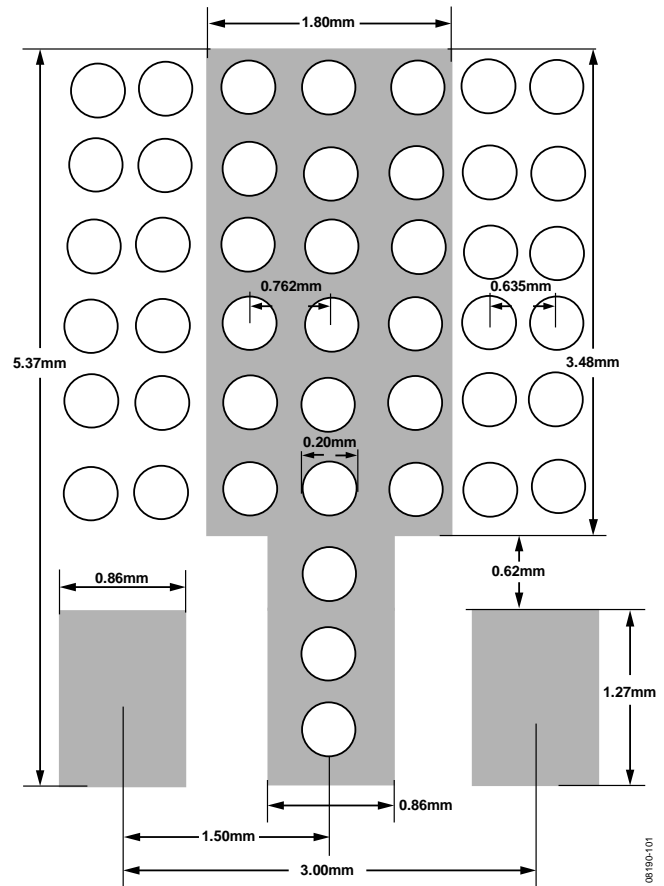

Figure 17. Recommended Land Pattern

Table 5. Recommended Components for Basic Connections

Frequency (MHz)	C1	C2	L1	C4	C5	C6
50 to 4000	0.1 μ F	0.1 μ F	470 nH (Coilcraft 0603LS-NX or equivalent)	68 pF	1.2 nF	1 μ F

W-CDMA ACPR PERFORMANCE

Figure 18 shows a plot of adjacent channel power ratio (ACPR) vs. P_{OUT} for the ADL5602. The signal type being used is a single W-CDMA carrier (Test Model 1-64) at 2140 MHz. This signal is generated by a very low ACPR source. ACPR is measured at the output by a high dynamic range spectrum analyzer, which incorporates an instrument noise correction function.

The ADL5602 achieves an ACPR of -75 dBc at -5 dBm output, at which point device noise and not distortion is beginning to dominate the power in the adjacent channels. At an output power of $+5$ dBm, ACPR is still very low at -61 dBc, making the device particularly suitable for PA driver applications.

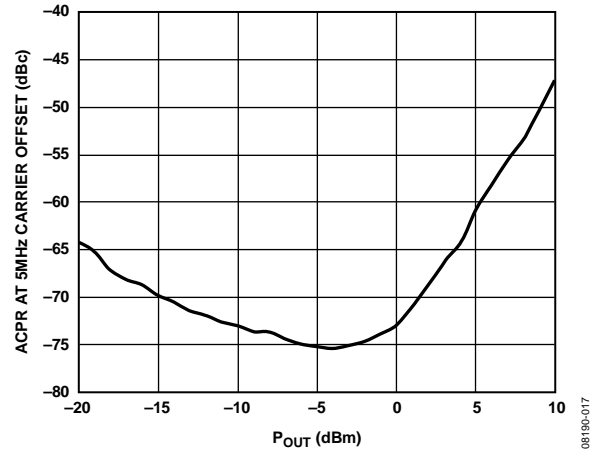

Figure 18. ACPR vs. P_{OUT} , Single Carrier W-CDMA (Test Model 1-64) at 2140 MHz Evaluation Board

EVALUATION BOARD

Figure 20 shows the schematic for the ADL5602 evaluation board. The board is powered by a single 5 V supply.

The components used on the board are listed in Table 6. Power can be applied to the board through clip-on leads (VCC and GND).

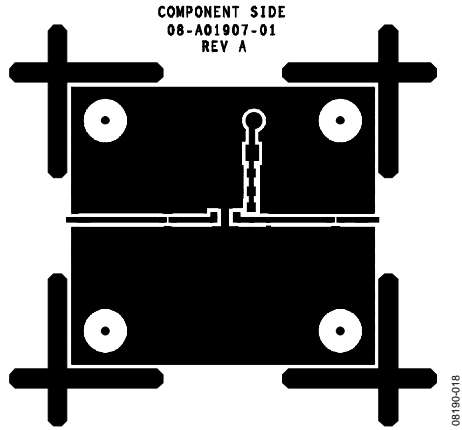

Figure 19. Evaluation Board Layout (Top)

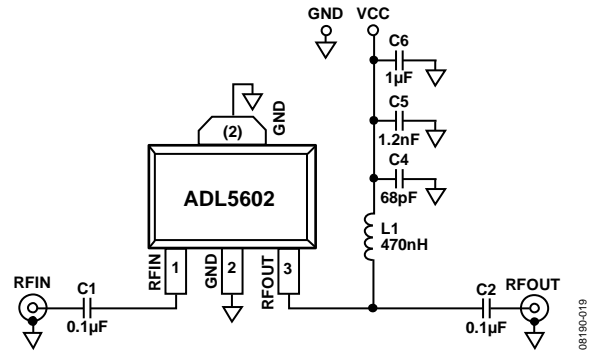
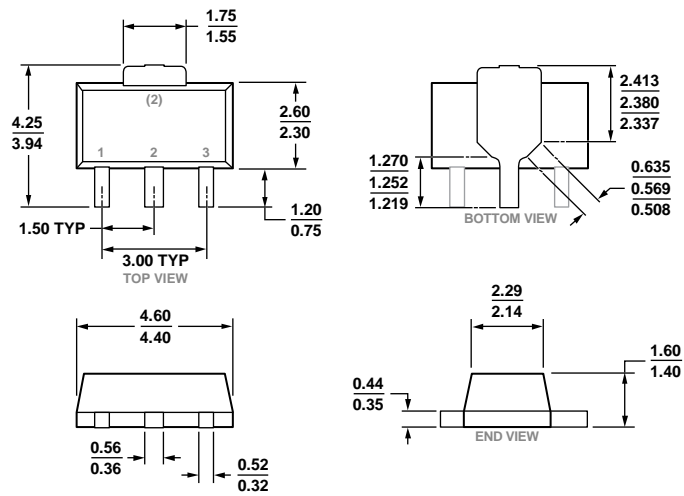

Figure 20. Evaluation Board Schematic

Table 6. Evaluation Board Configuration Options

Component	Description	Default Value
C1, C2	AC-coupling capacitors	0.1 μF, 0402
L1	DC bias inductor	470 nH, 0603 (Coilcraft 0603LS-NX or equivalent)
VCC and GND	Clip-on terminals for power supply	
C4, C5, C6	Power supply decoupling capacitors	C4 = 68 pF, 0603; C5 = 1.2 nF, 0603; C6 = 1 μF, 1206

OUTLINE DIMENSIONS



COMPLIANT TO JEDEC STANDARDS TO-243

Figure 21. 3-Lead Small Outline Transistor Package [SOT-89] (RK-3)
Dimensions shown in millimeters

ORDERING GUIDE

Model ¹	Temperature Range	Package Description	Package Option
ADL5602ARKZ-R7	-40°C to +85°C	3-Lead SOT-89, 7" Tape and Reel	RK-3
ADL5602-EVALZ		Evaluation Board	

¹ Z = RoHS Compliant Part.

NOTES