

# ADC14L040

## 14-Bit, 40 MSPS, 235 mW A/D Converter

### General Description

The ADC14L040 is a low power monolithic CMOS analog-to-digital converter capable of converting analog input signals into 14-bit digital words at 40 Megasamples per second (MSPS). This converter uses a differential, pipeline architecture with digital error correction and an on-chip sample-and-hold circuit to minimize power consumption while providing excellent dynamic performance and a 150 MHz Full Power Bandwidth. Operating on a single +3.3V power supply, the ADC14L040 achieves 11.9 effective bits at nyquist and consumes just 235 mW at 40 MSPS. The Power Down feature reduces power consumption to 15 mW.

The differential inputs provide a full scale differential input swing equal to 2 times  $V_{REF}$  with the possibility of a single-ended input. Full use of the differential input is recommended for optimum performance. Duty cycle stabilization and output data format are selectable using a quad state function pin. The output data can be set for offset binary or two's complement.

To ease interfacing to lower voltage systems, the digital output driver power pins of the ADC14L040 can be connected to a separate supply voltage in the range of 2.4V to the analog supply voltage.

This device is available in the 32-lead LQFP package and will operate over the industrial temperature range of  $-40^{\circ}\text{C}$  to  $+85^{\circ}\text{C}$ . An evaluation board is available to ease the evaluation process.

### Features

- Single +3.3V supply operation
- Internal sample-and-hold
- Internal reference
- Outputs 2.4V to 3.6V compatible
- Duty Cycle Stabilizer
- Power down mode

### Key Specifications

- |                             |                     |
|-----------------------------|---------------------|
| ■ Resolution                | 14 Bits             |
| ■ DNL                       | $\pm 0.5$ LSB (typ) |
| ■ SNR ( $f_{IN} = 10$ MHz)  | 74 dB (typ)         |
| ■ SFDR ( $f_{IN} = 10$ MHz) | 90 dB (typ)         |
| ■ Data Latency              | 7 Clock Cycles      |
| ■ Power Consumption         |                     |
| ■ -- Operating              | 235 mW (typ)        |
| ■ -- Power Down Mode        | 15 mW (typ)         |

### Applications

- Medical Imaging
- Instrumentation
- Communications
- Digital Video

### Connection Diagram

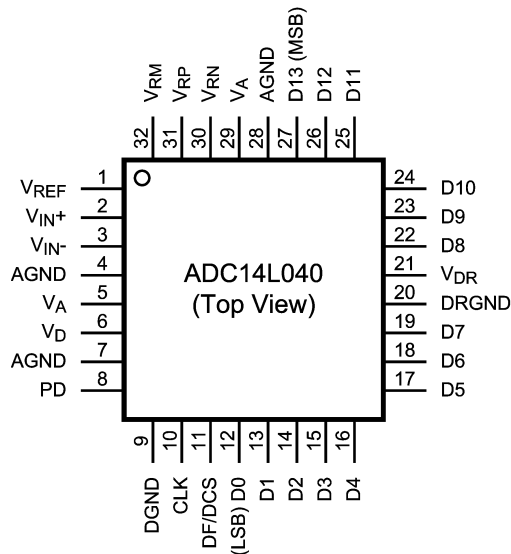

20146501

## Ordering Information

Industrial ( $-40^{\circ}\text{C} \leq T_A \leq +85^{\circ}\text{C}$ )	Package
ADC14L040CIVY	32 Pin LQFP
ADC14L040EVAL	Evaluation Board

## Block Diagram

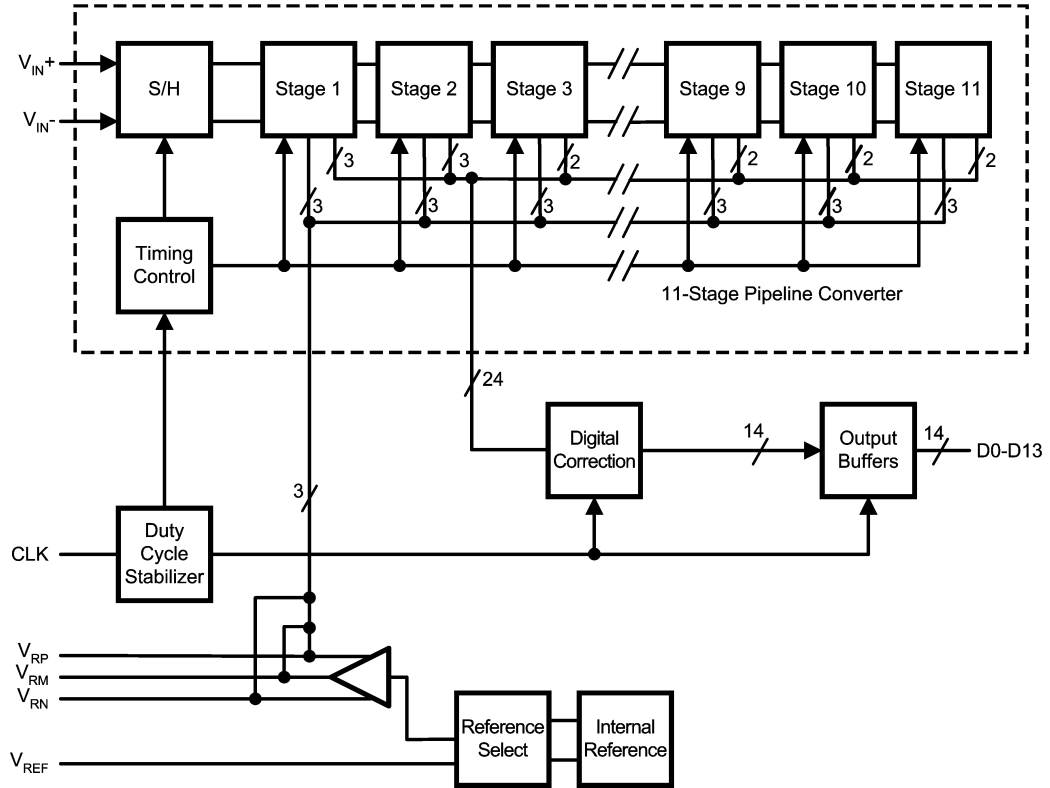

20146502

## Pin Descriptions and Equivalent Circuits

Pin No.	Symbol	Equivalent Circuit	Description
<b>ANALOG I/O</b>			
2	$V_{IN+}$		<p>Differential analog input pins. With a 1.0V reference voltage the differential full-scale input signal level is <math>2.0 V_{P-P}</math> with each input pin voltage centered on a common mode voltage, <math>V_{CM}</math>. The negative input pins may be connected to <math>V_{CM}</math> for single-ended operation, but a differential input signal is required for best performance.</p>
3	$V_{IN-}$		
1	$V_{REF}$		<p>This pin is the reference select pin and the external reference input.</p> <p>If <math>(V_A - 0.3V) &lt; V_{REF} &lt; V_A</math>, the internal 1.0V reference is selected.</p> <p>If <math>AGND &lt; V_{REF} &lt; (AGND + 0.3V)</math>, the internal 0.5V reference is selected.</p> <p>If a voltage in the range of 0.4V to <math>(V_A - 0.4V)</math> is applied to this pin, that voltage is used as the reference.</p> <p>The full scale differential voltage range is <math>2 * V_{REF}</math>. <math>V_{REF}</math> should be bypassed to AGND with a 0.1 <math>\mu F</math> capacitor when an external reference is used.</p>
31	$V_{RP}$		<p>These pins should each be bypassed to AGND with a low ESL (equivalent series inductance) 0.1 <math>\mu F</math> capacitor. A 10 <math>\mu F</math> capacitor should be placed between the <math>V_{RP}</math> and <math>V_{RN}</math>. <math>V_{RM}</math> may be loaded to 1mA for use as a temperature stable 1.5V reference. The remaining pins should not be loaded. <math>V_{RM}</math> may be used to provide the common mode voltage, <math>V_{CM}</math>, for the differential inputs.</p>
32	$V_{RM}$		
30	$V_{RN}$		
11	DF/DCS		<p>This is a four-state pin.</p> <p>DF/DCS = <math>V_A</math>, output data format is offset binary with duty cycle stabilization applied to the input clock</p> <p>DF/DCS = AGND, output data format is 2's complement, with duty cycle stabilization applied to the input clock.</p> <p>DF/DCS = <math>V_{RM}</math>, output data is 2's complement without duty cycle stabilization applied to the input clock</p> <p>DF/DCS = "float", output data is offset binary without duty cycle stabilization applied to the input clock.</p>
<b>DIGITAL I/O</b>			
10	CLK		<p>Digital clock input. The range of frequencies for this input is as specified in the electrical tables with guaranteed performance at 40 MHz. The input is sampled on the rising edge.</p>
8	PD		<p>PD is the Power Down input pin. When high, this input puts the converter into the power down mode. When this pin is low, the converter is in the active mode.</p>

## Pin Descriptions and Equivalent Circuits (Continued)

Pin No.	Symbol	Equivalent Circuit	Description
12-19 22-27	D0-D13		Digital data output pins that make up the 14-bit conversion result. D0 (pin 12) is the LSB, while D13 (pin 27) is the MSB of the output word. Output levels are TTL/CMOS compatible. Optimum loading is $< 10\text{pF}$ .
<b>ANALOG POWER</b>			
5, 29	$V_A$		Positive analog supply pins. These pins should be connected to a quiet +3.3V source and bypassed to AGND with $0.1\ \mu\text{F}$ capacitors located close to these power pins, and with a $10\ \mu\text{F}$ capacitor.
4, 7, 28	AGND		The ground return for the analog supply.
<b>DIGITAL POWER</b>			
6	$V_D$		Positive digital supply pin. This pin should be connected to the same quiet +3.3V source as is $V_A$ and be bypassed to DGND with a $0.1\ \mu\text{F}$ capacitor located close to the power pin and with a $10\ \mu\text{F}$ capacitor.
9	DGND		The ground return for the digital supply.
21	$V_{DR}$		Positive driver supply pin for the ADC14L040's output drivers. This pin should be connected to a voltage source of +2.4V to $V_D$ and be bypassed to DR GND with a $0.1\ \mu\text{F}$ capacitor. If the supply for this pin is different from the supply used for $V_A$ and $V_D$ , it should also be bypassed with a $10\ \mu\text{F}$ capacitor. $V_{DR}$ should never exceed the voltage on $V_D$ . All $0.1\ \mu\text{F}$ bypass capacitors should be located close to the supply pin.
20	DR GND		The ground return for the digital supply for the ADC's output drivers. These pins should be connected to the system digital ground, but not be connected in close proximity to the ADC's DGND or AGND pins. See Section 5 (Layout and Grounding) for more details.

## Absolute Maximum Ratings (Notes 1,

2)

If Military/Aerospace specified devices are required, please contact the National Semiconductor Sales Office/Distributors for availability and specifications.

$V_A, V_D, V_{DR}$	4.2V
$ V_A - V_D $	$\leq 100$ mV
Voltage on Any Input or Output Pin	-0.3V to ( $V_A$ or $V_D$ +0.3V)
Input Current at Any Pin (Note 3)	$\pm 25$ mA
Package Input Current (Note 3)	$\pm 50$ mA
Package Dissipation at $T_A = 25^\circ\text{C}$	See (Note 4)
ESD Susceptibility	
Human Body Model (Note 5)	2500V
Machine Model (Note 5)	250V
Storage Temperature	$-65^\circ\text{C}$ to $+150^\circ\text{C}$

Soldering process must comply with National Semiconductor's Reflow Temperature Profile specifications. Refer to [www.national.com/packaging](http://www.national.com/packaging). (Note 6)

## Operating Ratings (Notes 1, 2)

Operating Temperature	$-40^\circ\text{C} \leq T_A \leq +85^\circ\text{C}$
Supply Voltage ( $V_A, V_D$ )	+3.0V to +3.6V
Output Driver Supply ( $V_{DR}$ )	+2.4V to $V_D$
CLK, PD	-0.05V to ( $V_D + 0.05\text{V}$ )
Clock Duty Cycle (DCS On)	20% to 80%
Clock Duty Cycle (DCS Off)	40% to 60%
Analog Input Pins	0V to 2.6V
$V_{CM}$	0.5V to 2.0V
IAGND-DGNDI	$\leq 100$ mV

## Converter Electrical Characteristics

Unless otherwise specified, the following specifications apply for AGND = DGND = DR GND = 0V,  $V_A = V_D = +3.3\text{V}$ ,  $V_{DR} = +2.5\text{V}$ , PD = 0V, External  $V_{REF} = +1.0\text{V}$ ,  $f_{CLK} = 40$  MHz,  $f_{IN} = 20$  MHz at -0.5dBFS,  $t_r = t_f = 2$  ns,  $C_L = 15$  pF/pin, Duty Cycle Stabilizer On. **Boldface limits apply for  $T_J = T_{MIN}$  to  $T_{MAX}$** : all other limits  $T_J = 25^\circ\text{C}$  (Notes 7, 8, 9)

Symbol	Parameter	Conditions	Typical (Note 10)	Limits (Note 10)	Units (Limits)
<b>STATIC CONVERTER CHARACTERISTICS</b>					
	Resolution with No Missing Codes			<b>14</b>	Bits (min)
INL	Integral Non Linearity (Note 11)		$\pm 1.5$	<b><math>\pm 3.8</math></b>	LSB (max)
DNL	Differential Non Linearity		$\pm 0.5$	<b><math>\pm 1.0</math></b>	LSB (max)
PGE	Positive Gain Error		0.3	<b><math>\pm 3.3</math></b>	%FS (max)
NGE	Negative Gain Error		0.4	<b><math>\pm 3.3</math></b>	%FS (max)
TC GE	Gain Error Tempco	$-40^\circ\text{C} \leq T_A \leq +85^\circ\text{C}$	2.5		ppm/ $^\circ\text{C}$
$V_{OFF}$	Offset Error ( $V_{IN+} = V_{IN-}$ )		-0.06	<b><math>\pm 1.0</math></b>	%FS (max)
TC $V_{OFF}$	Offset Error Tempco	$-40^\circ\text{C} \leq T_A \leq +85^\circ\text{C}$	1.5		ppm/ $^\circ\text{C}$
	Under Range Output Code			<b>0</b>	
	Over Range Output Code			<b>16383</b>	
<b>REFERENCE AND ANALOG INPUT CHARACTERISTICS</b>					
$V_{CM}$	Common Mode Input Voltage		1.5	0.5	V (min)
				2.0	V (max)
$V_{RM}$	Reference Output Voltage	Output load = 1 mA	1.5		V
$C_{IN}$	$V_{IN}$ Input Capacitance (each pin to GND)	$V_{IN} = 1.5$ Vdc $\pm 0.5$ V	(CLK LOW)	11	pF
			(CLK HIGH)	4.5	pF
$V_{REF}$	External Reference Voltage (Note 13)		1.00	<b>0.8</b>	V (min)
				<b>1.2</b>	V (max)
	Reference Input Resistance		1		M $\Omega$ (min)

## Converter Electrical Characteristics (Continued)

Unless otherwise specified, the following specifications apply for AGND = DGND = DR GND = 0V,  $V_A = V_D = +3.3V$ ,  $V_{DR} = +2.5V$ , PD = 0V, External  $V_{REF} = +1.0V$ ,  $f_{CLK} = 40$  MHz,  $f_{IN} = 20$  MHz at -0.5dBFS,  $t_r = t_f = 2$  ns,  $C_L = 15$  pF/pin, Duty Cycle Stabilizer On. **Boldface limits apply for  $T_J = T_{MIN}$  to  $T_{MAX}$** : all other limits  $T_J = 25^\circ C$  (Notes 7, 8, 9)

Symbol	Parameter	Conditions	Typical (Note 10)	Limits (Note 10)	Units (Limits)
<b>DYNAMIC CONVERTER CHARACTERISTICS</b>					
FPBW	Full Power Bandwidth	0 dBFS Input, Output at -3 dB	150		MHz
SNR	Signal-to-Noise Ratio	$f_{IN} = 10$ MHz	74		dBc
		$f_{IN} = 20$ MHz	73.3	<b>71.7</b>	dBc
SINAD	Signal-to-Noise Ratio and Distortion	$f_{IN} = 10$ MHz	73.5		dBc
		$f_{IN} = 20$ MHz	73	<b>71.5</b>	dBc
ENOB	Effective Number of Bits	$f_{IN} = 10$ MHz	12		Bits
		$f_{IN} = 20$ MHz	11.9	<b>11.6</b>	Bits
THD	Total Harmonic Distortion	$f_{IN} = 10$ MHz	-86		dBc
		$f_{IN} = 20$ MHz	-86	<b>-77</b>	dBc
H2	Second Harmonic Distortion	$f_{IN} = 10$ MHz	-93		dBc
		$f_{IN} = 20$ MHz	-91	<b>-80</b>	dBc
H3	Third Harmonic Distortion	$f_{IN} = 10$ MHz	-90		dBc
		$f_{IN} = 20$ MHz	-94	<b>-80</b>	dBc
SFDR	Spurious Free Dynamic Range	$f_{IN} = 10$ MHz	90		dBc
		$f_{IN} = 20$ MHz	90	<b>80</b>	dBc
IMD	Intermodulation Distortion	$f_{IN} = 9.6$ MHz and 10.2 MHz, each = -6.5 dBFS	-79		dBFS

## DC and Logic Electrical Characteristics

Unless otherwise specified, the following specifications apply for AGND = DGND = DR GND = 0V,  $V_A = V_D = +3.3V$ ,  $V_{DR} = +2.5V$ , PD = 0V, External  $V_{REF} = +1.0V$ ,  $f_{CLK} = 40$  MHz,  $f_{IN} = 20$  MHz,  $t_r = t_f = 2$  ns,  $C_L = 15$  pF/pin, Duty Cycle Stabilizer On. **Boldface limits apply for  $T_J = T_{MIN}$  to  $T_{MAX}$** : all other limits  $T_J = 25^\circ C$  (Notes 7, 8, 9)

Symbol	Parameter	Conditions	Typical (Note 10)	Limits (Note 10)	Units (Limits)	
<b>CLK, PD DIGITAL INPUT CHARACTERISTICS</b>						
$V_{IN(1)}$	Logical "1" Input Voltage	$V_D = 3.6V$		<b>2.0</b>	V (min)	
$V_{IN(0)}$	Logical "0" Input Voltage	$V_D = 3.0V$		<b>1.0</b>	V (max)	
$I_{IN(1)}$	Logical "1" Input Current	$V_{IN} = 3.3V$	10		$\mu A$	
$I_{IN(0)}$	Logical "0" Input Current	$V_{IN} = 0V$	-10		$\mu A$	
$C_{IN}$	Digital Input Capacitance		5		pF	
<b>D0-D13 DIGITAL OUTPUT CHARACTERISTICS</b>						
$V_{OUT(1)}$	Logical "1" Output Voltage	$I_{OUT} = -0.5$ mA	$V_{DR} = 2.5V$		<b>2.3</b>	V (min)
			$V_{DR} = 3V$		<b>2.7</b>	V (min)
$V_{OUT(0)}$	Logical "0" Output Voltage	$I_{OUT} = 1.6$ mA, $V_{DR} = 3V$		<b>0.4</b>	V (max)	
+ $I_{SC}$	Output Short Circuit Source Current	$V_{OUT} = 0V$	-10		mA	
- $I_{SC}$	Output Short Circuit Sink Current	$V_{OUT} = V_{DR}$	10		mA	
$C_{OUT}$	Digital Output Capacitance		5		pF	
<b>POWER SUPPLY CHARACTERISTICS</b>						
$I_A$	Analog Supply Current	PD Pin = DGND, $V_{REF} = V_A$	63	<b>86</b>	mA (max)	
		PD Pin = $V_D$	4.5		mA	
$I_D$	Digital Supply Current	PD Pin = DGND	8	<b>12</b>	mA (max)	
		PD Pin = $V_D$ , $f_{CLK} = 0$	0		mA	
$I_{DR}$	Digital Output Supply Current	PD Pin = DGND, $C_L = 5$ pF (Note 14)	4		mA	
		PD Pin = $V_D$ , $f_{CLK} = 0$	0		mA	
	Total Power Consumption	PD Pin = DGND, $C_L = 5$ pF (Note 15)	235	<b>323</b>	mW (max)	

## DC and Logic Electrical Characteristics (Continued)

Unless otherwise specified, the following specifications apply for AGND = DGND = DR GND = 0V,  $V_A = V_D = +3.3V$ ,  $V_{DR} = +2.5V$ , PD = 0V, External  $V_{REF} = +1.0V$ ,  $f_{CLK} = 40$  MHz,  $f_{IN} = 20$  MHz,  $t_r = t_f = 2$  ns,  $C_L = 15$  pF/pin, Duty Cycle Stabilizer On. **Boldface limits apply for  $T_J = T_{MIN}$  to  $T_{MAX}$** ; all other limits  $T_J = 25^\circ C$  (Notes 7, 8, 9)

Symbol	Parameter	Conditions	Typical (Note 10)	Limits (Note 10)	Units (Limits)
	Power Down Power Consumption	PD Pin = $V_D$ , clock on	15		mW
PSRR	Power Supply Rejection Ratio	Rejection of Full-Scale Error with $V_A = 3.0V$ vs. 3.6V	72		dB

## AC Electrical Characteristics

Unless otherwise specified, the following specifications apply for AGND = DGND = DR GND = 0V,  $V_A = V_D = +3.3V$ ,  $V_{DR} = +2.5V$ , PD = 0V, External  $V_{REF} = +1.0V$ ,  $f_{CLK} = 40$  MHz,  $f_{IN} = 10$  MHz,  $t_r = t_f = 2$  ns,  $C_L = 15$  pF/pin, Duty Cycle Stabilizer On. **Boldface limits apply for  $T_J = T_{MIN}$  to  $T_{MAX}$** ; all other limits  $T_J = 25^\circ C$  (Notes 7, 8, 9, 12)

Symbol	Parameter	Conditions	Typical (Note 10)	Limits (Note 10)	Units (Limits)
$f_{CLK}^1$	Maximum Clock Frequency			<b>40</b>	MHz (min)
$f_{CLK}^2$	Minimum Clock Frequency		5		MHz
$t_{CH}$	Clock High Time	Duty Cycle Stabilizer On	12.5	5	ns (min)
$t_{CL}$	Clock Low Time	Duty Cycle Stabilizer On	12.5	5	ns (min)
$t_{CH}$	Clock High Time	Duty Cycle Stabilizer Off	12.5	10	ns (min)
$t_{CL}$	Clock Low Time	Duty Cycle Stabilizer Off	12.5	10	ns (min)
$t_{CONV}$	Conversion Latency			<b>7</b>	Clock Cycles
$t_{OD}$	Data Output Delay after Rising Clock Edge		6	<b>9.6</b>	ns (max)
$t_{AD}$	Aperture Delay		2		ns
$t_{AJ}$	Aperture Jitter		0.7		ps rms
$t_{PD}$	Power Down Mode Exit Cycle	0.1 $\mu F$ on pins 30, 31, 32; 10 $\mu F$ between pins 30, 31	280		$\mu s$

**Note 1:** Absolute Maximum Ratings indicate limits beyond which damage to the device may occur. Operating Ratings indicate conditions for which the device is functional, but do not guarantee specific performance limits. For guaranteed specifications and test conditions, see the Electrical Characteristics. The guaranteed specifications apply only for the test conditions listed. Some performance characteristics may degrade when the device is not operated under the listed test conditions.

**Note 2:** All voltages are measured with respect to GND = AGND = DGND = 0V, unless otherwise specified.

**Note 3:** When the input voltage at any pin exceeds the power supplies (that is,  $V_{IN} < AGND$ , or  $V_{IN} > V_A$ ), the current at that pin should be limited to 25 mA. The 50 mA maximum package input current rating limits the number of pins that can safely exceed the power supplies with an input current of 25 mA to two.

**Note 4:** The absolute maximum junction temperature ( $T_{Jmax}$ ) for this device is  $150^\circ C$ . The maximum allowable power dissipation is dictated by  $T_{Jmax}$ , the junction-to-ambient thermal resistance ( $\theta_{JA}$ ), and the ambient temperature, ( $T_A$ ), and can be calculated using the formula  $P_{DMAX} = (T_{Jmax} - T_A) / \theta_{JA}$ . The values for maximum power dissipation listed above will be reached only when the device is operated in a severe fault condition (e.g. when input or output pins are driven beyond the power supply voltages, or the power supply polarity is reversed). Obviously, such conditions should always be avoided.

**Note 5:** Human body model is 100 pF capacitor discharged through a 1.5 k $\Omega$  resistor. Machine model is 220 pF discharged through 0 $\Omega$ .

**Note 6:** Reflow temperature profiles are different for lead-free and non-lead-free packages.

**Note 7:** The inputs are protected as shown below. Input voltage magnitudes above  $V_A$  or below GND will not damage this device, provided current is limited per (Note 3). However, errors in the A/D conversion can occur if the input goes above  $V_A$  or below GND by more than 100 mV. As an example, if  $V_A$  is +3.3V, the full-scale input voltage must be  $\leq +3.4V$  to ensure accurate conversions.

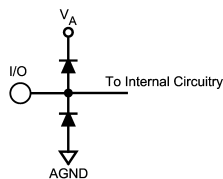

20146511

**Note 8:** To guarantee accuracy, it is required that  $|V_A - V_D| \leq 100$  mV and separate bypass capacitors are used at each power supply pin.

**Note 9:** With the test condition for  $V_{REF} = +1.0V$  (2V<sub>P-P</sub> differential input), the 14-bit LSB is 122.1  $\mu V$ .

**Note 10:** Typical figures are at  $T_J = 25^\circ C$ , and represent most likely parametric norms. Test limits are guaranteed to National's AOQL (Average Outgoing Quality Level).

## AC Electrical Characteristics (Continued)

**Note 11:** Integral Non Linearity is defined as the deviation of the analog value, expressed in LSBs, from the straight line that passes through positive and negative full-scale.

**Note 12:** Timing specifications are tested at TTL logic levels,  $V_{IL} = 0.4V$  for a falling edge and  $V_{IH} = 2.4V$  for a rising edge.

**Note 13:** Optimum performance will be obtained by keeping the reference input in the 0.8V to 1.2V range. The LM4051CIM3-ADJ (SOT-23 package) is recommended for external reference applications.

**Note 14:**  $I_{DR}$  is the current consumed by the switching of the output drivers and is primarily determined by load capacitance on the output pins, the supply voltage,  $V_{DR}$ , and the rate at which the outputs are switching (which is signal dependent).  $I_{DR} = V_{DR}(C_0 \times f_0 + C_1 \times f_1 + \dots + C_{11} \times f_{11})$  where  $V_{DR}$  is the output driver power supply voltage,  $C_n$  is total capacitance on the output pin, and  $f_n$  is the average frequency at which that pin is toggling.

**Note 15:** Excludes  $I_{DR}$ . See note 14.



## Specification Definitions

**APERTURE DELAY** is the time after the rising edge of the clock to when the input signal is acquired or held for conversion.

**APERTURE JITTER (APERTURE UNCERTAINTY)** is the variation in aperture delay from sample to sample. Aperture jitter manifests itself as noise in the output.

**CLOCK DUTY CYCLE** is the ratio of the time during one cycle that a repetitive digital waveform is high to the total time of one period. The specification here refers to the ADC clock input signal.

**COMMON MODE VOLTAGE ( $V_{CM}$ )** is the common d.c. voltage applied to both input terminals of the ADC.

**CONVERSION LATENCY** is the number of clock cycles between initiation of conversion and when that data is presented to the output driver stage. Data for any given sample is available at the output pins the Pipeline Delay plus the Output Delay after the sample is taken. New data is available at every clock cycle, but the data lags the conversion by the pipeline delay.

**DIFFERENTIAL NON-LINEARITY (DNL)** is the measure of the maximum deviation from the ideal step size of 1 LSB.

**EFFECTIVE NUMBER OF BITS (ENOB, or EFFECTIVE BITS)** is another method of specifying Signal-to-Noise and Distortion or SINAD. ENOB is defined as  $(\text{SINAD} - 1.76) / 6.02$  and says that the converter is equivalent to a perfect ADC of this (ENOB) number of bits.

**FULL POWER BANDWIDTH** is a measure of the frequency at which the reconstructed output fundamental drops 3 dB below its low frequency value for a full scale input.

**GAIN ERROR** is the deviation from the ideal slope of the transfer function. It can be calculated as:

$$\text{Gain Error} = \text{Positive Full Scale Error} - \text{Negative Full Scale Error}$$

It can also be expressed as Positive Gain Error and Negative Gain Error, which are calculated as:

$$\begin{aligned} \text{PGE} &= \text{Positive Full Scale Error} - \text{Offset Error} \\ \text{NGE} &= \text{Offset Error} - \text{Negative Full Scale Error} \end{aligned}$$

**INTEGRAL NON LINEARITY (INL)** is a measure of the deviation of each individual code from a line drawn from negative full scale ( $1/2$  LSB below the first code transition) through positive full scale ( $1/2$  LSB above the last code transition). The deviation of any given code from this straight line is measured from the center of that code value.

**INTERMODULATION DISTORTION (IMD)** is the creation of additional spectral components as a result of two sinusoidal frequencies being applied to the ADC input at the same time. It is defined as the ratio of the power in the intermodulation products to the total power in the original frequencies. IMD is usually expressed in dBFS.

**LSB (LEAST SIGNIFICANT BIT)** is the bit that has the smallest value or weight of all bits. This value is  $V_{FS}/2^n$ , where " $V_{FS}$ " is the full scale input voltage and " $n$ " is the ADC resolution in bits.

**MISSING CODES** are those output codes that will never appear at the ADC outputs. The ADC14L040 is guaranteed not to have any missing codes.

**MSB (MOST SIGNIFICANT BIT)** is the bit that has the largest value or weight. Its value is one half of full scale.

**NEGATIVE FULL SCALE ERROR** is the difference between the actual first code transition and its ideal value of  $1/2$  LSB above negative full scale.

**OFFSET ERROR** is the difference between the two input voltages  $[(V_{IN+}) - (V_{IN-})]$  required to cause a transition from code 8191 to 8192.

**OUTPUT DELAY** is the time delay after the rising edge of the clock before the data update is presented at the output pins.

**PIPELINE DELAY (LATENCY)** See CONVERSION LATENCY.

**POSITIVE FULL SCALE ERROR** is the difference between the actual last code transition and its ideal value of  $1/2$  LSB below positive full scale.

**POWER SUPPLY REJECTION RATIO (PSRR)** is a measure of how well the ADC rejects a change in the power supply voltage. PSRR is the ratio of the change in Full-Scale Error that results from a change in the d.c. power supply voltage, expressed in dB.

**SIGNAL TO NOISE RATIO (SNR)** is the ratio, expressed in dB, of the rms value of the input signal to the rms value of the sum of all other spectral components below one-half the sampling frequency, not including harmonics or d.c.

**SIGNAL TO NOISE PLUS DISTORTION (S/N+D or SINAD)** is the ratio, expressed in dB, of the rms value of the input signal to the rms value of all of the other spectral components below half the clock frequency, including harmonics but excluding d.c.

**SPURIOUS FREE DYNAMIC RANGE (SFDR)** is the difference, expressed in dB, between the rms values of the input signal and the peak spurious signal, where a spurious signal is any signal present in the output spectrum that is not present at the input.

**TOTAL HARMONIC DISTORTION (THD)** is the ratio, expressed in dB, of the rms total of the first nine harmonic levels at the output to the level of the fundamental at the output. THD is calculated as

$$\text{THD} = 20 \times \log \sqrt{\frac{f_2^2 + \dots + f_{10}^2}{f_1^2}}$$

where  $f_1$  is the RMS power of the fundamental (output) frequency and  $f_2$  through  $f_{10}$  are the RMS power of the first 9 harmonic frequencies in the output spectrum.

**SECOND HARMONIC DISTORTION (2ND HARM)** is the difference expressed in dB, between the RMS power in the input frequency at the output and the power in its 2nd harmonic level at the output.

**THIRD HARMONIC DISTORTION (3RD HARM)** is the difference, expressed in dB, between the RMS power in the input frequency at the output and the power in its 3rd harmonic level at the output.

### Timing Diagram

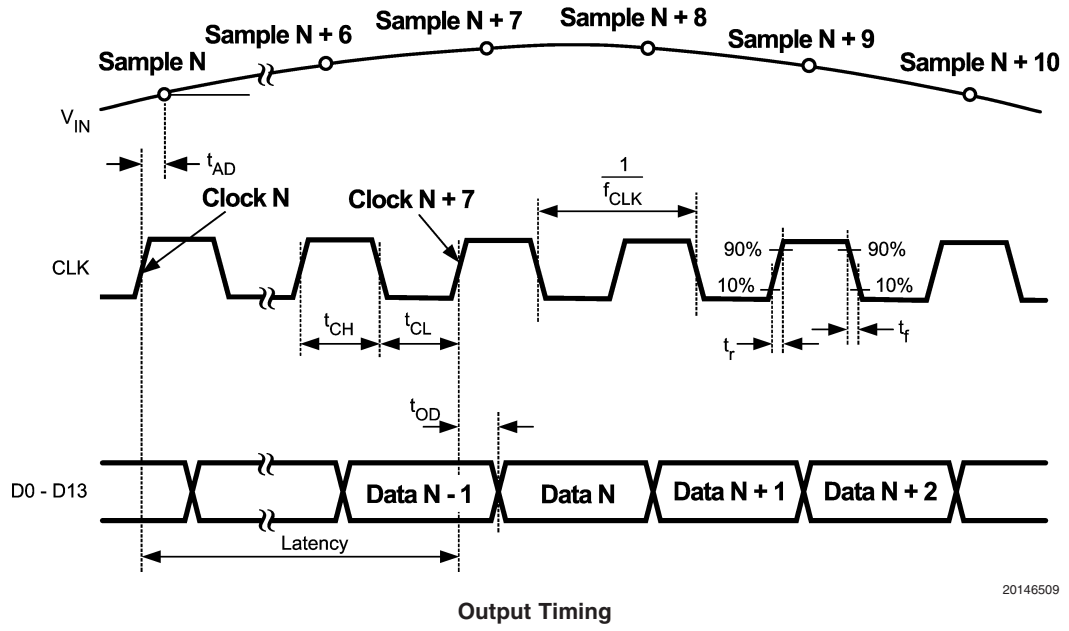

20146509

### Transfer Characteristic

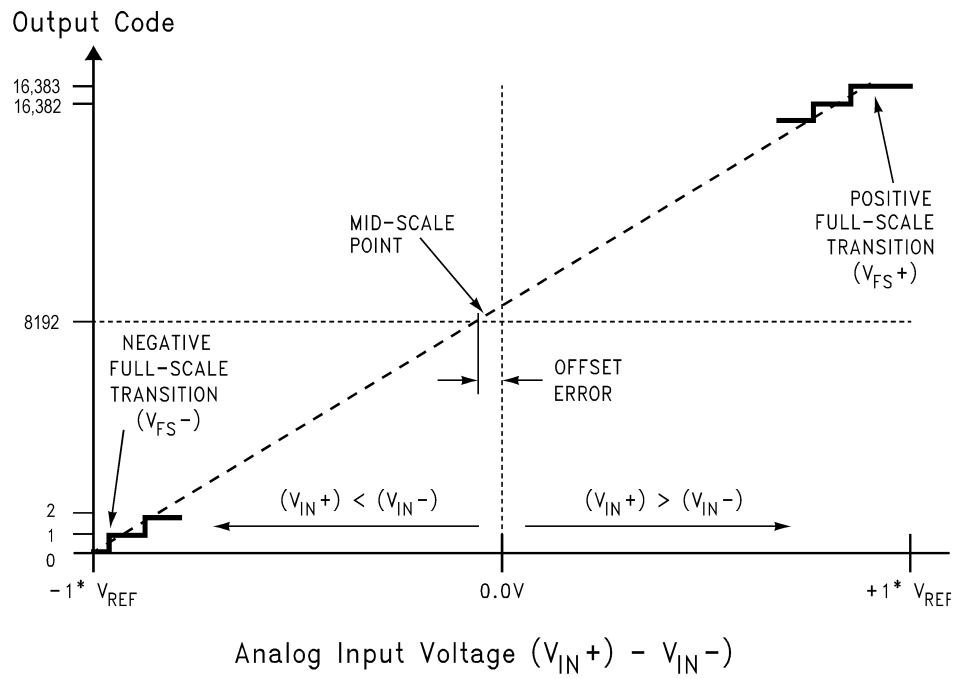

20146510

FIGURE 1. Transfer Characteristic

**Typical Performance Characteristics, DNL, INL** Unless otherwise specified, the following specifications apply for AGND = DGND = DR GND = 0V,  $V_A = V_D = +3.3V$ ,  $V_{DR} = +2.5V$ , PD = 0V, External  $V_{REF} = +1.0V$ ,  $f_{CLK} = 40$  MHz,  $f_{IN} = 0$  MHz,  $t_r = t_f = 2$  ns,  $C_L = 15$  pF/pin, Duty Cycle Stabilizer On. **Boldface limits apply for  $T_J = T_{MIN}$  to  $T_{MAX}$** ; all other limits  $T_J = 25^\circ C$

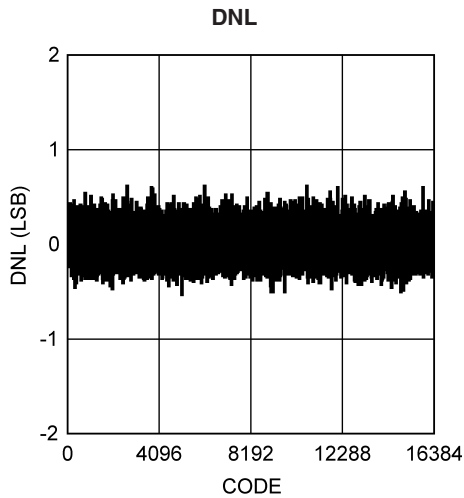

20146561

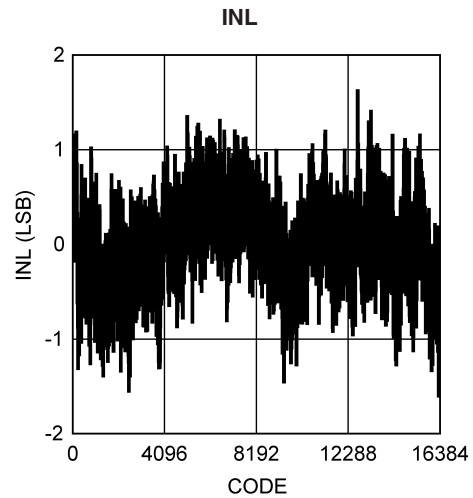

20146562

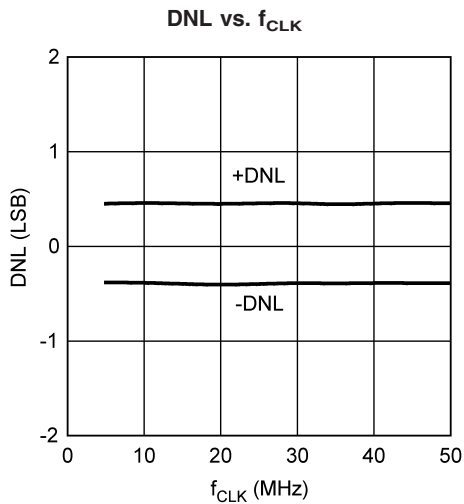

20146563

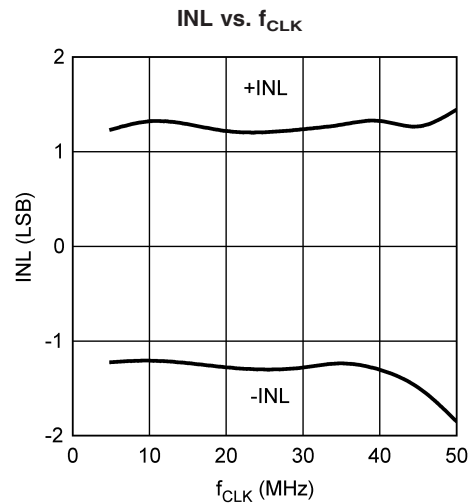

20146564

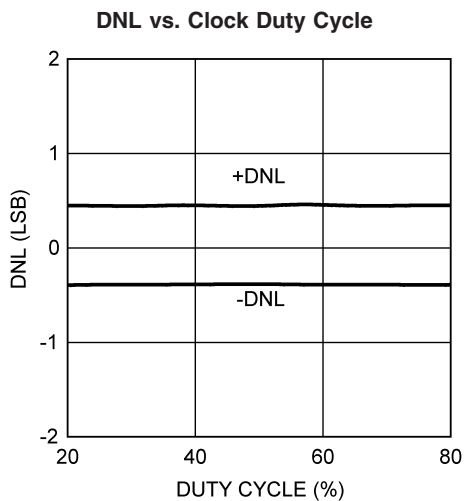

20146565

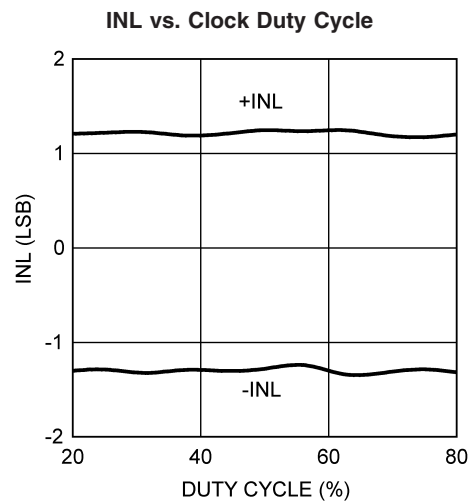

20146566

**Typical Performance Characteristics, DNL, INL** Unless otherwise specified, the following specifications apply for AGND = DGND = DR GND = 0V,  $V_A = V_D = +3.3V$ ,  $V_{DR} = +2.5V$ , PD = 0V, External  $V_{REF} = +1.0V$ ,  $f_{CLK} = 40$  MHz,  $f_{IN} = 0$  MHz,  $t_r = t_f = 2$  ns,  $C_L = 15$  pF/pin, Duty Cycle Stabilizer On. **Boldface limits apply for  $T_J = T_{MIN}$  to  $T_{MAX}$** : all other limits  $T_J = 25^\circ C$  (Continued)

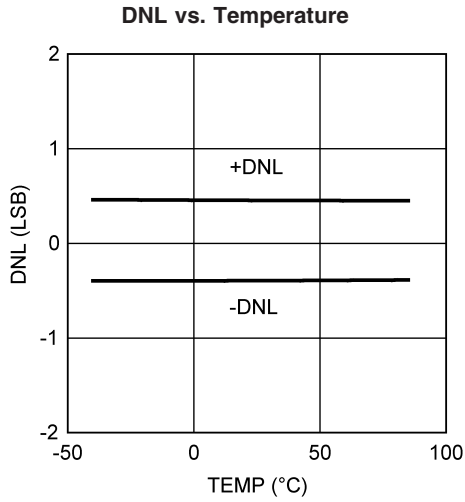

20146567

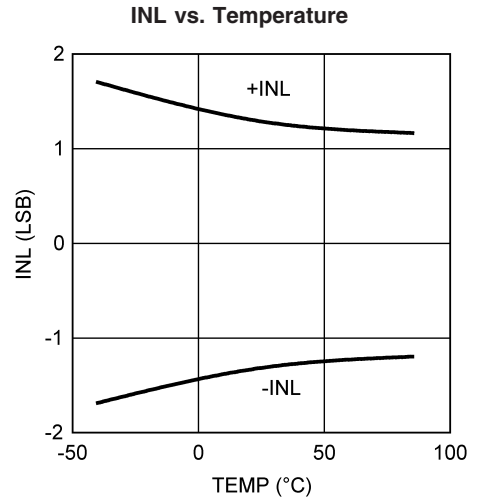

20146568

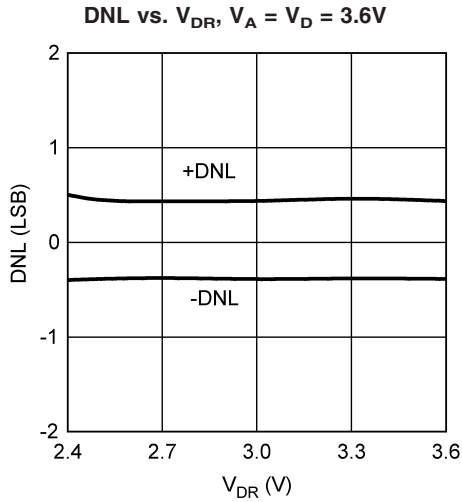

20146569

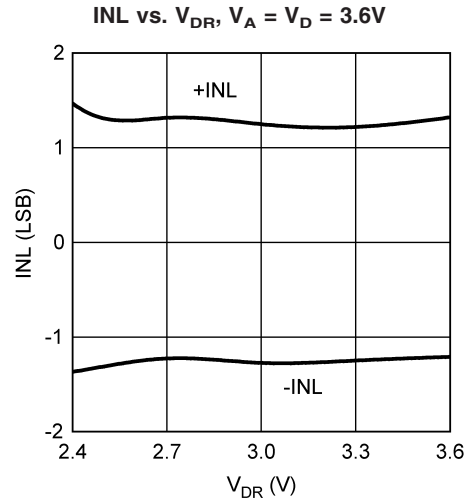

20146570

### Typical Performance Characteristics

Unless otherwise specified, the following specifications apply for AGND = DGND = DR GND = 0V,  $V_A = V_D = +3.3V$ ,  $V_{DR} = +2.5V$ , PD = 0V, External  $V_{REF} = +1.0V$ ,  $f_{CLK} = 40\text{ MHz}$ ,  $f_{IN} = 20\text{ MHz}$ ,  $t_r = t_f = 2\text{ ns}$ ,  $C_L = 15\text{ pF/pin}$ , Duty Cycle Stabilizer On. **Boldface limits apply for  $T_J = T_{MIN}$  to  $T_{MAX}$** : all other limits  $T_J = 25^\circ\text{C}$

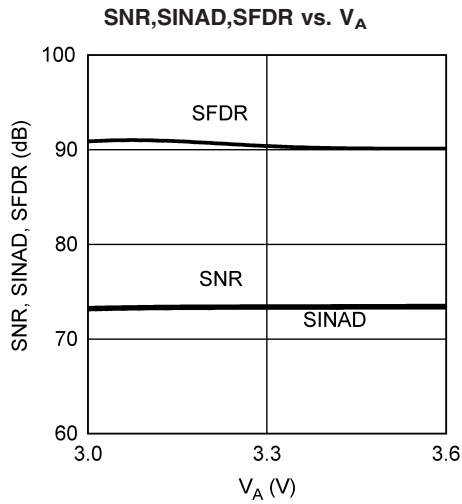

20146571

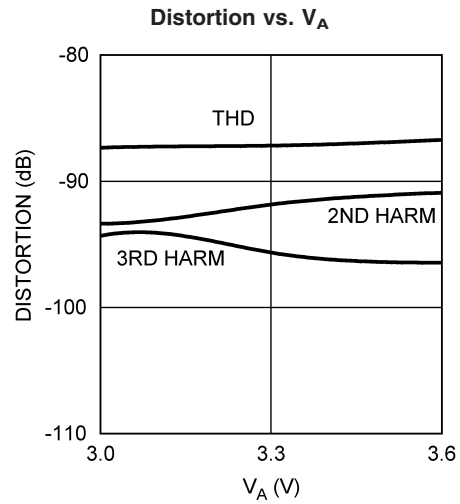

20146572

**SNR, SINAD, SFDR vs.  $V_{DR}$ ,  $V_A = V_D = 3.6V$**

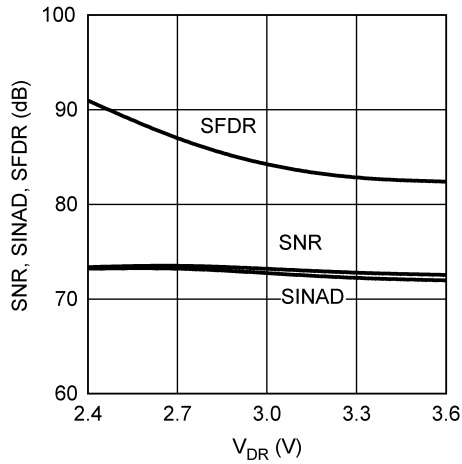

20146573

**Distortion vs.  $V_{DR}$ ,  $V_A = V_D = 3.6V$**

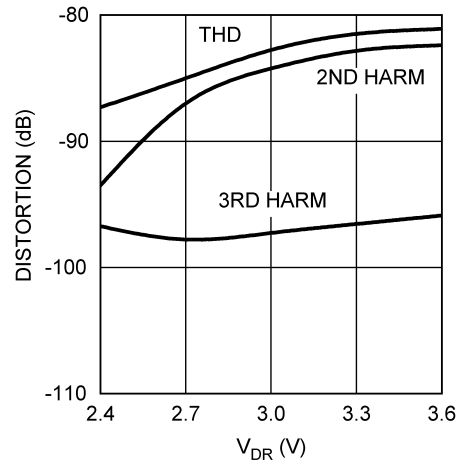

20146574

**SNR, SINAD, SFDR vs.  $V_{CM}$**

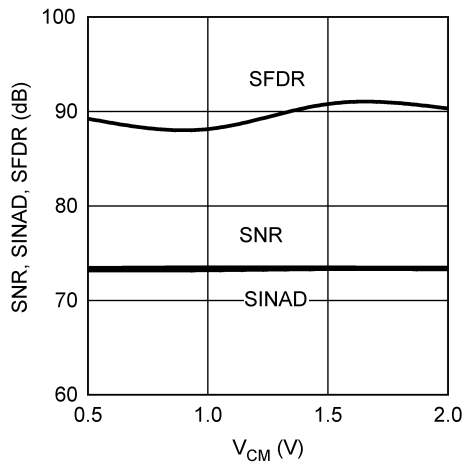

20146575

**Distortion vs.  $V_{CM}$**

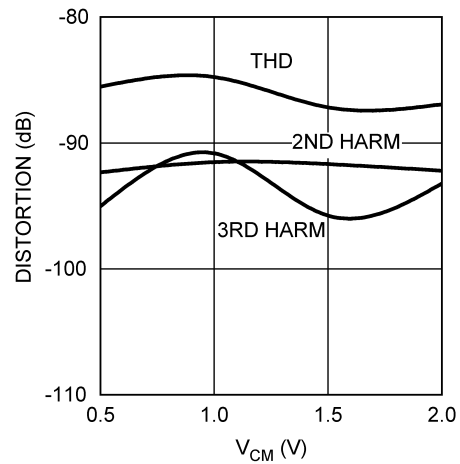

20146576

### Typical Performance Characteristics

Unless otherwise specified, the following specifications apply for AGND = DGND = DR GND = 0V,  $V_A = V_D = +3.3V$ ,  $V_{DR} = +2.5V$ , PD = 0V, External  $V_{REF} = +1.0V$ ,  $f_{CLK} = 40$  MHz,  $f_{IN} = 20$  MHz,  $t_r = t_f = 2$  ns,  $C_L = 15$  pF/pin, Duty Cycle Stabilizer On. **Boldface limits apply for  $T_J = T_{MIN}$  to  $T_{MAX}$** : all other limits  $T_J = 25^\circ C$  (Continued)

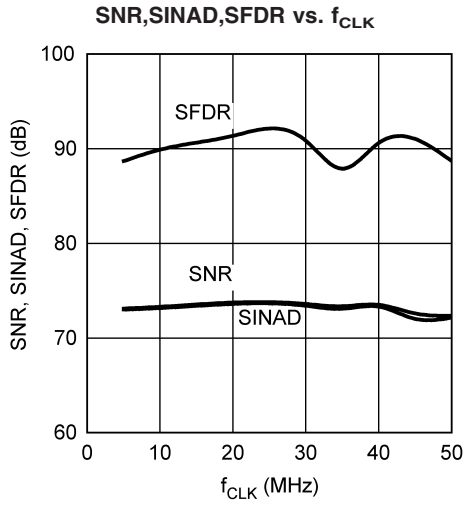

20146577

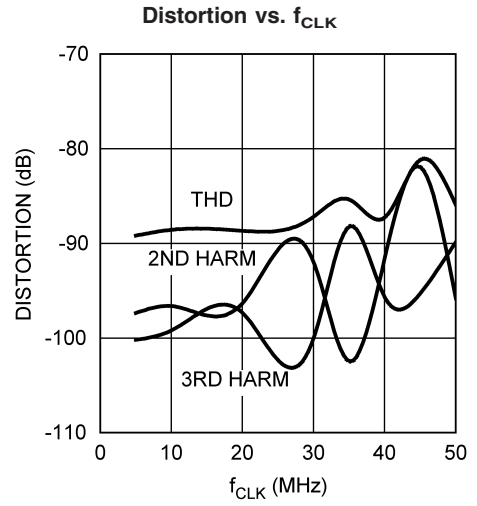

20146578

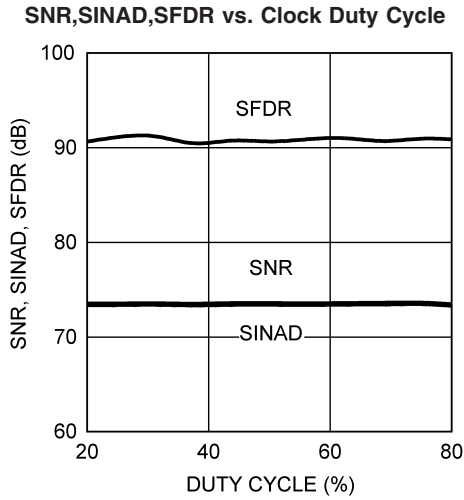

20146579

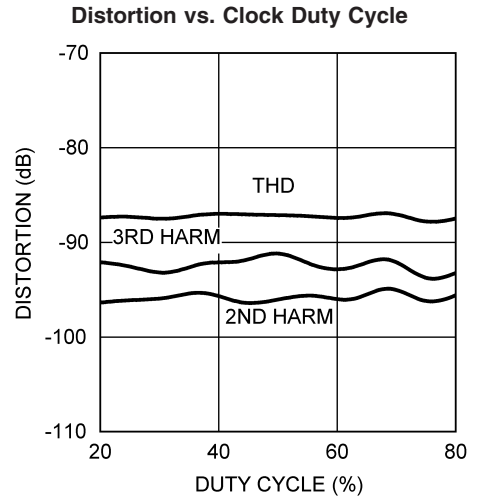

20146580

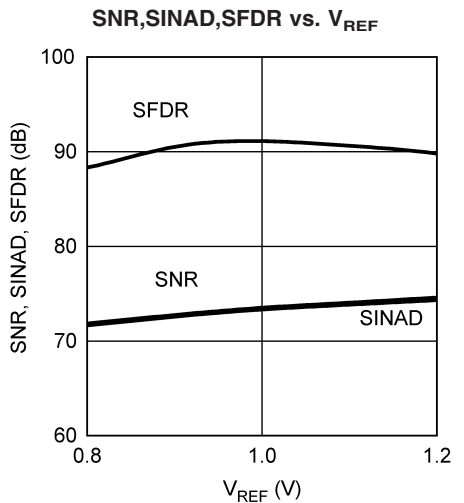

20146581

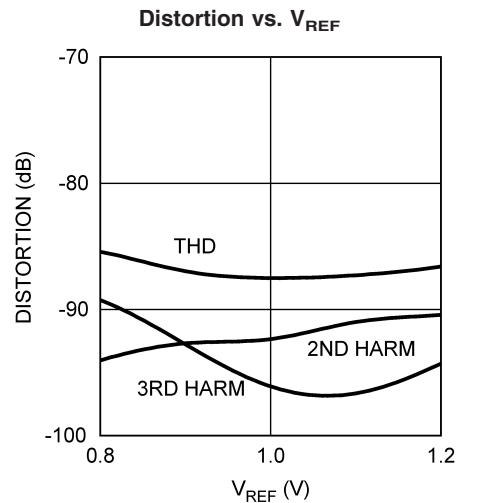

20146582

### Typical Performance Characteristics

Unless otherwise specified, the following specifications apply for AGND = DGND = DR GND = 0V,  $V_A = V_D = +3.3V$ ,  $V_{DR} = +2.5V$ , PD = 0V, External  $V_{REF} = +1.0V$ ,  $f_{CLK} = 40$  MHz,  $f_{IN} = 20$  MHz,  $t_r = t_f = 2$  ns,  $C_L = 15$  pF/pin, Duty Cycle Stabilizer On. **Boldface limits apply for  $T_J = T_{MIN}$  to  $T_{MAX}$** : all other limits  $T_J = 25^\circ C$  (Continued)

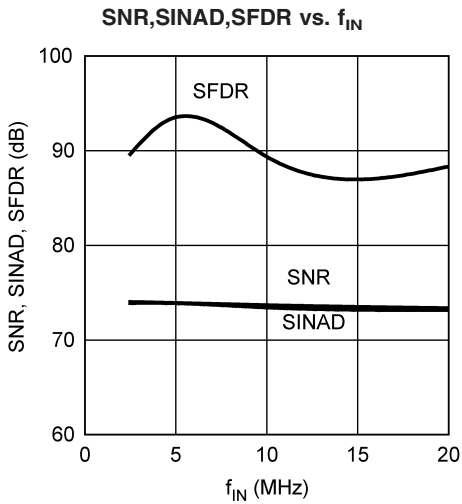

20146583

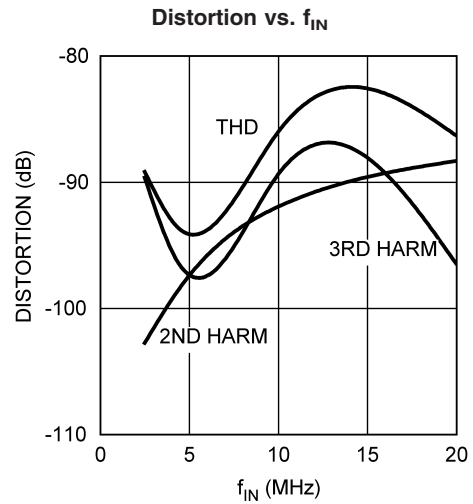

20146584

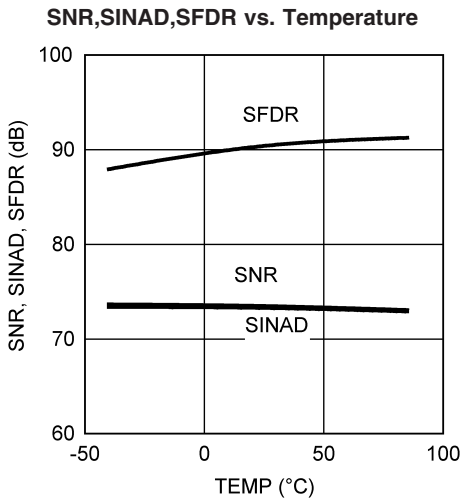

20146585

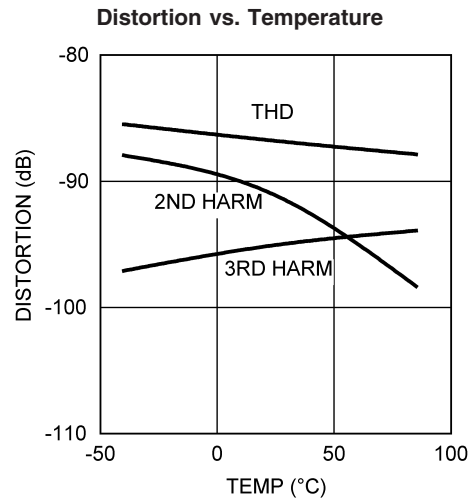

20146586

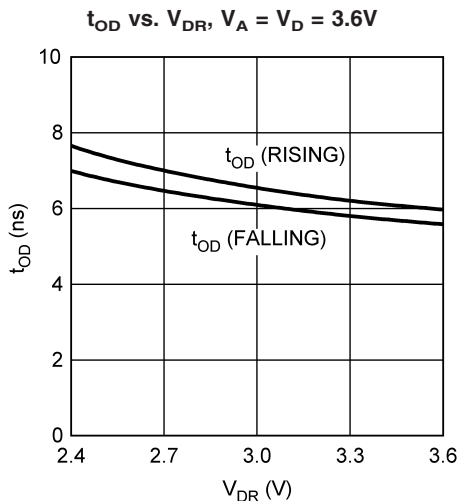

20146587

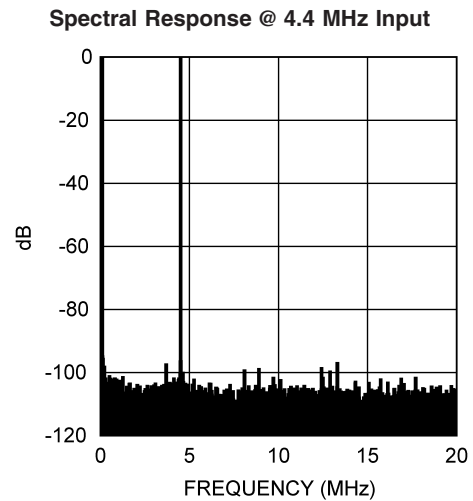

20146591

**Typical Performance Characteristics**

Unless otherwise specified, the following specifications apply for AGND = DGND = DR GND = 0V,  $V_A = V_D = +3.3V$ ,  $V_{DR} = +2.5V$ , PD = 0V, External  $V_{REF} = +1.0V$ ,  $f_{CLK} = 40\text{ MHz}$ ,  $f_{IN} = 20\text{ MHz}$ ,  $t_r = t_f = 2\text{ ns}$ ,  $C_L = 15\text{ pF/pin}$ , Duty Cycle Stabilizer On. **Boldface limits apply for  $T_J = T_{MIN}$  to  $T_{MAX}$** ; all other limits  $T_J = 25^\circ\text{C}$  (Continued)

**Spectral Response @ 10 MHz Input**

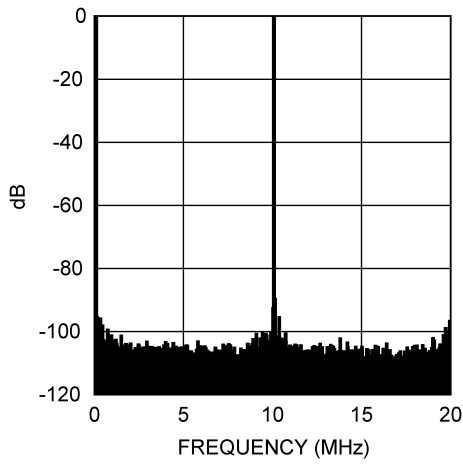

20146588

**Spectral Response @ 20 MHz Input**

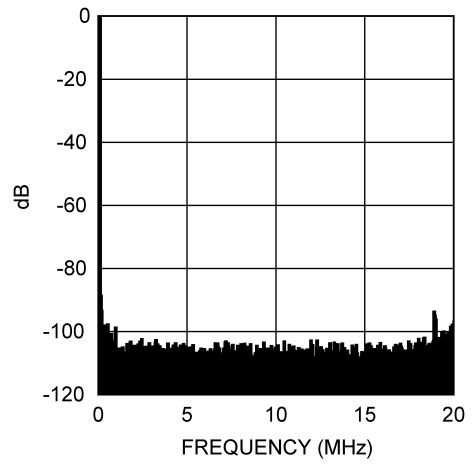

20146589

**Intermodulation Distortion,  $f_{IN1} = 9.6\text{ MHz}$ ,  $f_{IN2} = 10.2\text{ MHz}$**

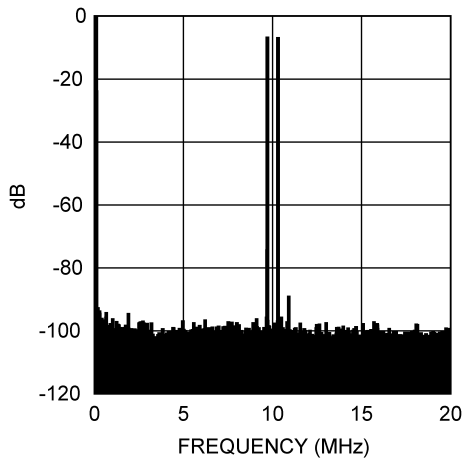

20146590



## Functional Description

Operating on a single +3.3V supply, the ADC14L040 uses a pipeline architecture and has error correction circuitry to help ensure maximum performance. The differential analog input signal is digitized to 14 bits. The user has the choice of using an internal 1.0 Volt or 0.5 Volt stable reference, or using an external reference. Any external reference is buffered on-chip to ease the task of driving that pin.

The output word rate is the same as the clock frequency. For the ADC14L040 the clock frequency can be between 5 MSPS and 40 MSPS (typical) with fully specified performance at 40 MSPS. The analog input is acquired at the rising edge of the clock and the digital data for a given sample is delayed by the pipeline for 7 clock cycles. Duty cycle stabilization and output data format are selectable using the quad state function DF/DCS pin. The output data can be set for offset binary or two's complement.

A logic high on the power down (PD) pin reduces the converter power consumption to 15 mW.

## Applications Information

### 1.0 OPERATING CONDITIONS

We recommend that the following conditions be observed for operation of the ADC14L040:

- $3.0V \leq V_A \leq 3.6V$
- $V_D = V_A$
- $2.4V \leq V_{DR} \leq V_A$
- $5 \text{ MHz} \leq f_{CLK} \leq 40 \text{ MHz}$
- $0.8V \leq V_{REF} \leq 1.2V$  (for an external reference)
- $0.5V \leq V_{CM} \leq 2.0V$

### 1.1 Analog Inputs

There is one reference input pin,  $V_{REF}$ , which is used to select an internal reference, or to supply an external reference. The ADC14L040 has one analog signal input pairs,  $V_{IN+}$  and  $V_{IN-}$ . This pair of pins forms a differential input pair.

### 1.2 Reference Pins

The ADC14L040 is designed to operate with an internal 1.0V or 0.5V reference, or an external 1.0V reference, but performs well with external reference voltages in the range of 0.8V to 1.2V. Lower reference voltages will decrease the signal-to-noise ratio (SNR) of the ADC14L040. Increasing the reference voltage (and the input signal swing) beyond 1.2V may degrade THD for a full-scale input, especially at higher input frequencies.

It is important that all grounds associated with the reference voltage and the analog input signal make connection to the ground plane at a single, quiet point to minimize the effects of noise currents in the ground path.

The Reference Bypass Pins ( $V_{RP}$ ,  $V_{RM}$ , and  $V_{RN}$ ) are made available for bypass purposes. All these pins should each be bypassed to ground with a 0.1  $\mu\text{F}$  capacitor. A 10  $\mu\text{F}$  capacitor should be placed between the  $V_{RP}$  and  $V_{RN}$  pins, as shown in *Figure 4*. This configuration is necessary to avoid reference oscillation, which could result in reduced SFDR and/or SNR.  $V_{RM}$  may be loaded to 1mA for use as a temperature stable 1.5V reference. The remaining pins should not be loaded.

Smaller capacitor values than those specified will allow faster recovery from the power down mode, but may result in degraded noise performance. Loading any of these pins other than  $V_{RM}$  may result in performance degradation.

The nominal voltages for the reference bypass pins are as follows:

$$\begin{aligned} V_{RM} &= 1.5 \text{ V} \\ V_{RP} &= V_{RM} + V_{REF} / 2 \\ V_{RN} &= V_{RM} - V_{REF} / 2 \end{aligned}$$

User choice of an on-chip or external reference voltage is provided. The internal 1.0 Volt reference is in use when the the  $V_{REF}$  pin is connected to  $V_A$ . When the  $V_{REF}$  pin is connected to AGND, the internal 0.5 Volt reference is in use. If a voltage in the range of 0.8V to 1.2V is applied to the  $V_{REF}$  pin, that is used for the voltage reference. When an external reference is used, the  $V_{REF}$  pin should be bypassed to ground with a 0.1  $\mu\text{F}$  capacitor close to the reference input pin. There is no need to bypass the  $V_{REF}$  pin when the internal reference is used.

### 1.3 Signal Inputs

The signal inputs are  $V_{IN+}$  and  $V_{IN-}$ . The input signal,  $V_{IN}$ , is defined as

$$V_{IN} = (V_{IN+}) - (V_{IN-})$$

*Figure 2* shows the expected input signal range. Note that the common mode input voltage,  $V_{CM}$ , should be in the range of 0.5V to 2.0V.

The peaks of the individual input signals should each never exceed 2.6V.

The ADC14L040 performs best with a differential input signal with each input centered around a common mode voltage,  $V_{CM}$ . The peak-to-peak voltage swing at each analog input pin should not exceed the value of the reference voltage or the output data will be clipped.

The two input signals should be exactly 180° out of phase from each other and of the same amplitude. For single frequency inputs, angular errors result in a reduction of the effective full scale input. For complex waveforms, however, angular errors will result in distortion.

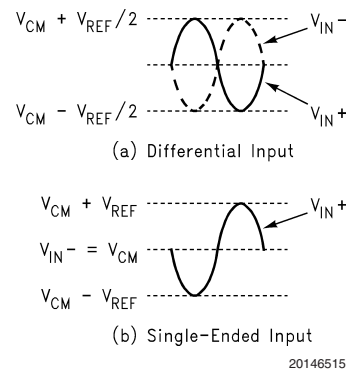

FIGURE 2. Expected Input Signal Range

For single frequency sine waves the full scale error in LSB can be described as approximately

$$E_{FS} = 16384 (1 - \sin(90^\circ + \text{dev}))$$

Where dev is the angular difference in degrees between the two signals having a 180° relative phase relationship to each other (see *Figure 3*). Drive the analog inputs with a source impedance less than 100 $\Omega$ .

**Applications Information** (Continued)

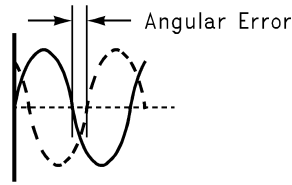

20146516

**FIGURE 3. Angular Errors Between the Two Input Signals Will Reduce the Output Level or Cause Distortion**

For differential operation, each analog input pin of the differential pair should have a peak-to-peak voltage equal to the reference voltage,  $V_{REF}$ , be 180 degrees out of phase with each other and be centered around  $V_{CM}$ .

**1.3.1 Single-Ended Operation**

Performance with a differential input signal is better than with a single-ended signal. For this reason, single-ended operation is not recommended. However, if single ended-operation is required and the resulting performance degradation is acceptable, one of the analog inputs should be connected to the d.c. mid point voltage of the driven input. The peak-to-peak differential input signal at the driven input pin should be twice the reference voltage to maximize SNR and SINAD performance (Figure 2b). For example, set  $V_{REF}$  to 1.0V, bias  $V_{IN-}$  to 1.5V and drive  $V_{IN+}$  with a signal range of 0.5V to 2.5V.

Because very large input signal swings can degrade distortion performance, better performance with a single-ended input can be obtained by reducing the reference voltage when maintaining a full-range output. Table 1 and Table 2 indicate the input to output relationship of the ADC14L040.

**TABLE 1. Input to Output Relationship – Differential Input**

$V_{IN+}$	$V_{IN-}$	Binary Output	2's Complement Output
$V_{CM} - V_{REF}/2$	$V_{CM} + V_{REF}/2$	00 0000 0000 0000	10 0000 0000 0000
$V_{CM} - V_{REF}/4$	$V_{CM} + V_{REF}/4$	01 0000 0000 0000	11 0000 0000 0000
$V_{CM}$	$V_{CM}$	10 0000 0000 0000	00 0000 0000 0000
$V_{CM} + V_{REF}/4$	$V_{CM} - V_{REF}/4$	11 0000 0000 0000	01 0000 0000 0000
$V_{CM} + V_{REF}/2$	$V_{CM} - V_{REF}/2$	11 1111 1111 1111	01 1111 1111 1111

**TABLE 2. Input to Output Relationship – Single-Ended Input**

$V_{IN+}$	$V_{IN-}$	Binary Output	2's Complement Output
$V_{CM} - V_{REF}$	$V_{CM}$	00 0000 0000 0000	10 0000 0000 0000

$V_{IN+}$	$V_{IN-}$	Binary Output	2's Complement Output
$V_{CM} - V_{REF}/2$	$V_{CM}$	01 0000 0000 0000	11 0000 0000 0000
$V_{CM}$	$V_{CM}$	10 0000 0000 0000	00 0000 0000 0000
$V_{CM} + V_{REF}/2$	$V_{CM}$	11 0000 0000 0000	01 0000 0000 0000
$V_{CM} + V_{REF}$	$V_{CM}$	11 1111 1111 1111	01 1111 1111 1111

**1.3.2 Driving the Analog Inputs**

The  $V_{IN+}$  and the  $V_{IN-}$  inputs of the ADC14L040 consist of an analog switch followed by a switched-capacitor amplifier. The capacitance seen at the analog input pins changes with the clock level, appearing as 11 pF when the clock is low, and 4.5 pF when the clock is high.

As the internal sampling switch opens and closes, current pulses occur at the analog input pins, resulting in voltage spikes at the signal input pins. As a driving amplifier attempts to counteract these voltage spikes, a damped oscillation may appear at the ADC analog input. Do not attempt to filter out these pulses. Rather, use amplifiers to drive the ADC14L040 input pins that are able to react to these pulses and settle before the switch opens and another sample is taken. The LMH6702, LMH6628, LMH6622 and the LMH6655 are good amplifiers for driving the ADC14L040.

To help isolate the pulses at the ADC input from the amplifier output, use RCs at the inputs, as can be seen in Figure 4. These components should be placed close to the ADC inputs because the input pins of the ADC is the most sensitive part of the system and this is the last opportunity to filter that input.

For Nyquist applications the RC pole should be at the ADC sample rate. The ADC input capacitance in the sample mode should be considered when setting the RC pole. For wide-band undersampling applications, the RC pole should be set at about 1.5 to 2 times the maximum input frequency to maintain a linear delay response.

A single-ended to differential conversion circuit is shown in Figure 5. Table 3 gives resistor values for that circuit to provide input signals in a range of 1.0V ±0.5V at each of the differential input pins of the ADC14L040.

**TABLE 3. Resistor Values for Circuit of Figure 5**

SIGNAL RANGE	R1	R2	R3	R4	R5, R6
0 - 0.25V	open	0Ω	124Ω	1500Ω	1000Ω
0 - 0.5V	0Ω	openΩ	499Ω	1500Ω	499Ω
±0.25V	100Ω	698Ω	100Ω	698Ω	499Ω

**1.3.3 Input Common Mode Voltage**

The input common mode voltage,  $V_{CM}$ , should be in the range of 0.5V to 2.0V and be a value such that the peak excursions of the analog signal does not go more negative than ground or more positive than 2.6V. See Section 1.2

**2.0 DIGITAL INPUTS**

Digital TTL/CMOS compatible inputs consist of CLK, PD, and DF/DCS.

## Applications Information (Continued)

### 2.1 CLK

The **CLK** signal controls the timing of the sampling process. Drive the clock input with a stable, low jitter clock signal in the range indicated in the Electrical Table with rise and fall times of 2 ns or less. The trace carrying the clock signal should be as short as possible and should not cross any other signal line, analog or digital, not even at 90°.

The **CLK** signal also drives an internal state machine. If the **CLK** is interrupted, or its frequency too low, the charge on internal capacitors can dissipate to the point where the accuracy of the output data will degrade. This is what limits the minimum sample rate.

The clock line should be terminated at its source in the characteristic impedance of that line. Take care to maintain a constant clock line impedance throughout the length of the line. Refer to Application Note AN-905 for information on setting characteristic impedance.

It is highly desirable that the source driving the ADC **CLK** pin only drive that pin. However, if that source is used to drive other things, each driven pin should be a.c. terminated with a series RC to ground, as shown in *Figure 4*, such that the resistor value is equal to the characteristic impedance of the clock line and the capacitor value is

$$C \geq \frac{4 \times t_{PD} \times L}{Z_0}$$

where  $t_{PD}$  is the signal propagation rate down the clock line, "L" is the line length and  $Z_0$  is the characteristic impedance of the clock line. This termination should be as close as possible to the ADC clock pin but beyond it as seen from the clock source. Typical  $t_{PD}$  is about 150 ps/inch (60 ps/cm) on FR-4 board material. The units of "L" and  $t_{PD}$  should be the same (inches or centimeters).

The duty cycle of the clock signal can affect the performance of the A/D Converter. Because achieving a precise duty cycle is difficult, the ADC14L040 has a Duty Cycle Stabilizer which can be enabled using the DF/DCS pin. It is designed to maintain performance over a clock duty cycle range of 20% to 80%.

### 2.2 PD

The PD pin, when high, holds the ADC14L040 in a power-down mode to conserve power when the converter is not being used. The power consumption in this state is 15 mW. The output data pins are undefined and the data in the pipeline is corrupted while in the power down mode.

The Power Down Mode Exit Cycle time is determined by the value of the components on pins 30, 31 and 32 and is about 280  $\mu$ s with the recommended components on the  $V_{RP}$ ,  $V_{RM}$  and  $V_{RN}$  reference bypass pins. These capacitors lose their charge in the Power Down mode and must be recharged by on-chip circuitry before conversions can be accurate. Smaller capacitor values allow slightly faster recovery from

the power down mode, but can result in a reduction in SNR, SINAD and ENOB performance.

### 2.3 DF/DCS

Duty cycle stabilization and output data format are selectable using this quad state function pin. When enabled, duty cycle stabilization can compensate for clock inputs with duty cycles ranging from 20% to 80% and generate a stable internal clock, improving the performance of the part.

With DF/DCS =  $V_A$  the output data format is offset binary and duty cycle stabilization is applied to the clock. With DF/DCS = 0 the output data format is 2's complement and duty cycle stabilization is applied to the clock. With DF/DCS =  $V_{RM}$  the output data format is 2's complement and duty cycle stabilization is not used. If DF/DCS is floating, the output data format is offset binary and duty cycle stabilization is not used. While the sense of this pin may be changed "on the fly," doing this is not recommended as the output data could be erroneous for a few clock cycles after this change is made.

### 3.0 OUTPUTS

The ADC14L040 has 14 TTL/CMOS compatible Data Output pins. Valid data is present at these outputs while the PD pins is low. Data should be captured with the CLK signal. Depending on the setup and hold time requirements of the receiving circuit (ASIC), either the rising edge or the falling edge of the CLK signal can be used to latch the data. Generally, rising-edge capture would maximize setup time with minimal hold time; while falling-edge-capture would maximize hold time with minimal setup time. However, actual timing for the falling-edge case depends greatly on the CLK frequency and both cases also depend on the delays inside the ASIC. Refer to the  $t_{OD}$  spec in the AC Electrical Characteristics table.

Be very careful when driving a high capacitance bus. The more capacitance the output drivers must charge for each conversion, the more instantaneous digital current flows through  $V_{DR}$  and DR GND. These large charging current spikes can cause on-chip ground noise and couple into the analog circuitry, degrading dynamic performance. Adequate bypassing, limiting output capacitance and careful attention to the ground plane will reduce this problem. Additionally, bus capacitance beyond the specified 15 pF/pin will cause  $t_{OD}$  to increase, making it difficult to properly latch the ADC output data. The result could be an apparent reduction in dynamic performance.

To minimize noise due to output switching, minimize the load currents at the digital outputs. This can be done by connecting buffers (74ACQ541, for example) between the ADC outputs and any other circuitry. Only one driven input should be connected to each output pin. Additionally, inserting series resistors of about 33 $\Omega$  at the digital outputs, close to the ADC pins, will isolate the outputs from trace and other circuit capacitances and limit the output currents, which could otherwise result in performance degradation. See *Figure 4*.

Applications Information (Continued)

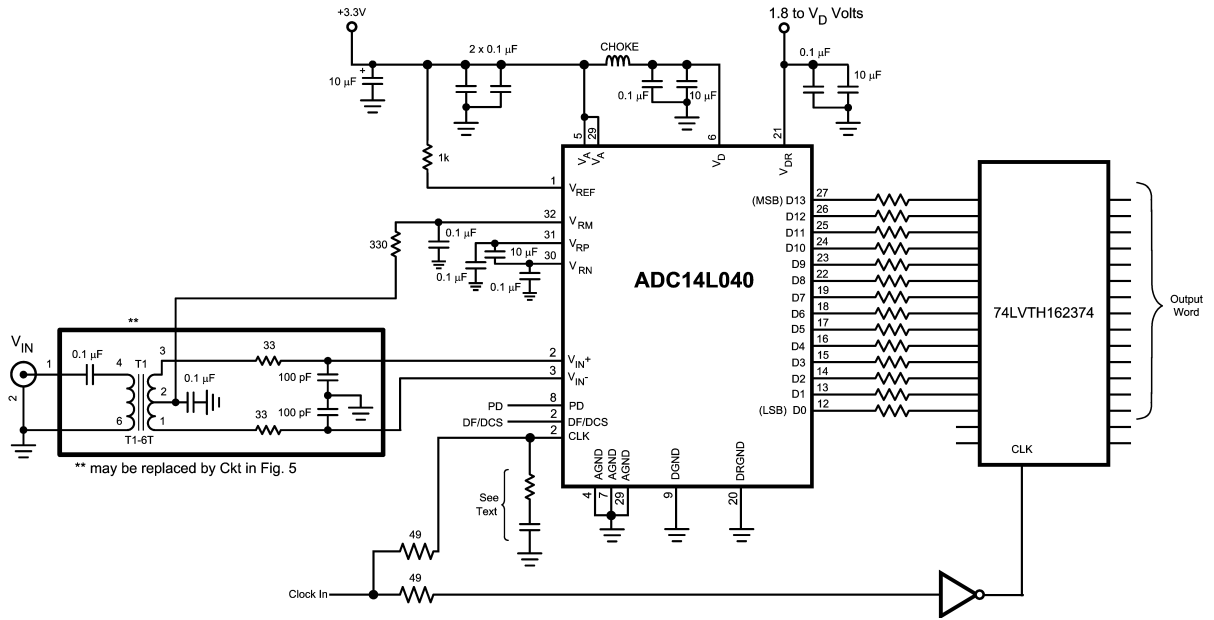

20146513

FIGURE 4. Application Circuit using Transformer Drive Circuit

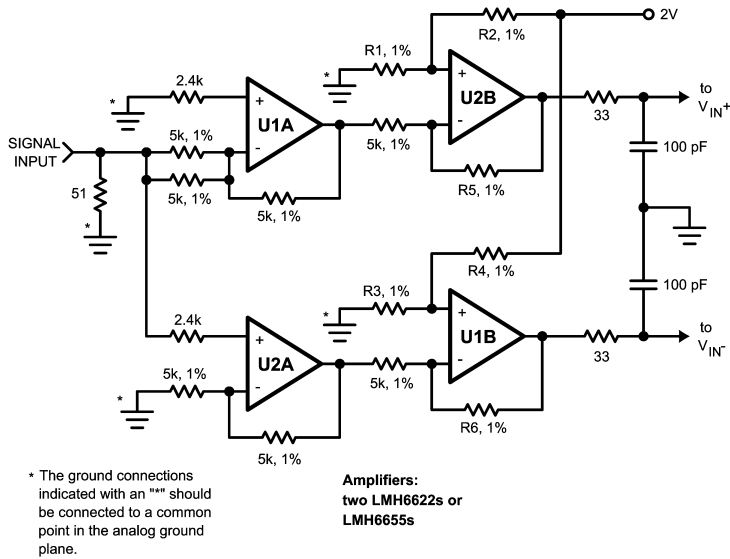

20146514

FIGURE 5. Differential Drive Circuit of Figure 4

4.0 POWER SUPPLY CONSIDERATIONS

The power supply pins should be bypassed with a 10 µF capacitor and with a 0.1 µF ceramic chip capacitor close to each power pin. Leadless chip capacitors are preferred because they have low series inductance.

As is the case with all high-speed converters, the ADC14L040 is sensitive to power supply noise. Accordingly, the noise on the analog supply pin should be kept below 100 mV<sub>P-P</sub>.

No pin should ever have a voltage on it that is in excess of the supply voltages, not even on a transient basis. Be especially careful of this during power turn on and turn off.

The V<sub>DR</sub> pin provides power for the output drivers and may be operated from a supply in the range of 2.4V to V<sub>D</sub>. This can simplify interfacing to lower voltage devices and systems. Note, however, that t<sub>OD</sub> increases with reduced V<sub>DR</sub>. **DO NOT operate the V<sub>DR</sub> pin at a voltage higher than V<sub>D</sub>.**

## Applications Information (Continued)

### 5.0 LAYOUT AND GROUNDING

Proper grounding and proper routing of all signals are essential to ensure accurate conversion. Maintaining separate analog and digital areas of the board, with the ADC14L040 between these areas, is required to achieve specified performance.

The ground return for the data outputs (DR GND) carries the ground current for the output drivers. The output current can exhibit high transients that could add noise to the conversion process. To prevent this from happening, the DR GND pins should NOT be connected to system ground in close proximity to any of the ADC14L040's other ground pins.

Capacitive coupling between the typically noisy digital circuitry and the sensitive analog circuitry can lead to poor performance. The solution is to keep the analog circuitry separated from the digital circuitry, and to keep the clock line as short as possible.

Digital circuits create substantial supply and ground current transients. The logic noise thus generated could have significant impact upon system noise performance. The best logic family to use in systems with A/D converters is one which employs non-saturating transistor designs, or has low noise characteristics, such as the 74LS, 74HC(T) and 74AC(T)Q families. The worst noise generators are logic families that draw the largest supply current transients during clock or signal edges, like the 74F and the 74AC(T) families.

The effects of the noise generated from the ADC output switching can be minimized through the use of 33Ω resistors in series with each data output line. Locate these resistors as close to the ADC output pins as possible.

Since digital switching transients are composed largely of high frequency components, total ground plane copper weight will have little effect upon the logic-generated noise. This is because of the skin effect. Total surface area is more important than is total ground plane area.

Generally, analog and digital lines should cross each other at 90° to avoid crosstalk. To maximize accuracy in high speed, high resolution systems, however, avoid crossing analog and digital lines altogether. It is important to keep clock lines as short as possible and isolated from ALL other lines, including other digital lines. Even the generally accepted 90° crossing should be avoided with the clock line as even a little coupling can cause problems at high frequencies. This is because other lines can introduce jitter into the clock line, which can lead to degradation of SNR. Also, the high speed clock can introduce noise into the analog chain.

Best performance at high frequencies and at high resolution is obtained with a straight signal path. That is, the signal path through all components should form a straight line wherever possible.

Be especially careful with the layout of inductors. Mutual inductance can change the characteristics of the circuit in which they are used. Inductors should *not* be placed side by side, even with just a small part of their bodies beside each other.

The analog input should be isolated from noisy signal traces to avoid coupling of spurious signals into the input. Any external component (e.g., a filter capacitor) connected between the converter's input pins and ground or to the reference input pin and ground should be connected to a very clean point in the ground plane.

All analog circuitry (input amplifiers, filters, reference components, etc.) should be placed in the analog area of the board. All digital circuitry and I/O lines should be placed in the digital area of the board. The ADC14L040 should be between these two areas. Furthermore, all components in the reference circuitry and the input signal chain that are connected to ground should be connected together with short traces and enter the ground plane at a single, quiet point. All ground connections should have a low inductance path to ground.

### 6.0 DYNAMIC PERFORMANCE

To achieve the best dynamic performance, the clock source driving the CLK input must be free of jitter. Isolate the ADC clock from any digital circuitry with buffers, as with the clock tree shown in *Figure 6*. The gates used in the clock tree must be capable of operating at frequencies much higher than those used if added jitter is to be prevented.

Best performance will be obtained with a differential input drive, compared with a single-ended drive, as discussed in Sections 1.3.1 and 1.3.2.

As mentioned in Section 5.0, it is good practice to keep the ADC clock line as short as possible and to keep it well away from any other signals. Other signals can introduce jitter into the clock signal, which can lead to reduced SNR performance, and the clock can introduce noise into other lines. Even lines with 90° crossings have capacitive coupling, so try to avoid even these 90° crossings of the clock line.

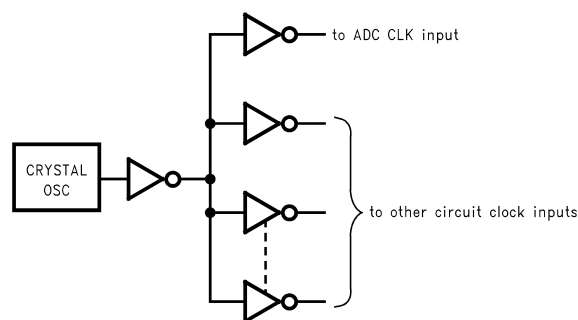

20146517

**FIGURE 6. Isolating the ADC Clock from other Circuitry with a Clock Tree**

### 7.0 COMMON APPLICATION PITFALLS

**Driving the inputs (analog or digital) beyond the power supply rails.** For proper operation, all inputs should not go more than 100 mV beyond the supply rails (more than 100 mV below the ground pins or 100 mV above the supply pins). Exceeding these limits on even a transient basis may cause faulty or erratic operation. It is not uncommon for high speed digital components (e.g., 74F and 74AC devices) to exhibit overshoot or undershoot that goes above the power supply or below ground. A resistor of about 47Ω to 100Ω in series with any offending digital input, close to the signal source, will eliminate the problem.

Do not allow input voltages to exceed the supply voltage, even on a transient basis. Not even during power up or power down.

Be careful not to overdrive the inputs of the ADC14L040 with a device that is powered from supplies outside the range of the ADC14L040 supply. Such practice may lead to conversion inaccuracies and even to device damage.

## Applications Information (Continued)

### Attempting to drive a high capacitance digital data bus.

The more capacitance the output drivers must charge for each conversion, the more instantaneous digital current flows through  $V_{DR}$  and DR GND. These large charging current spikes can couple into the analog circuitry, degrading dynamic performance. Adequate bypassing and maintaining separate analog and digital areas on the pc board will reduce this problem.

Additionally, bus capacitance beyond the specified 15 pF/pin will cause  $t_{OD}$  to increase, making it difficult to properly latch the ADC output data. The result could, again, be an apparent reduction in dynamic performance.

The digital data outputs should be buffered (with 74ACQ541, for example). Dynamic performance can also be improved by adding series resistors at each digital output, close to the ADC14L040, which reduces the energy coupled back into the converter output pins by limiting the output current. A reasonable value for these resistors is 33 $\Omega$ .

### Using an inadequate amplifier to drive the analog input.

As explained in Section 1.3, the capacitance seen at the input alternates between 11 pF and 4.5 pF, depending upon the phase of the clock. This dynamic load is more difficult to drive than is a fixed capacitance.

If the amplifier exhibits overshoot, ringing, or any evidence of instability, even at a very low level, it will degrade performance. A small series resistor at each amplifier output and a capacitor at the analog inputs (as shown in *Figure 5*) will

improve performance. The LMH6702 and the LMH6628 have been successfully used to drive the analog inputs of the ADC14L040.

Also, it is important that the signals at the two inputs have exactly the same amplitude and be exactly 180° out of phase with each other. Board layout, especially equality of the length of the two traces to the input pins, will affect the effective phase between these two signals. Remember that an operational amplifier operated in the non-inverting configuration will exhibit more time delay than will the same device operating in the inverting configuration.

**Operating with the reference pins outside of the specified range.** As mentioned in Section 1.2, when using an external reference,  $V_{REF}$  should be in the range of

$$0.8V \leq V_{REF} \leq 1.2V$$

Operating outside of these limits could lead to performance degradation.

**Inadequate network on Reference Bypass pins ( $V_{RP}$ ,  $V_{RN}$ , and  $V_{RM}$ ).** As mentioned in Section 1.2, these pins should be bypassed with 0.1  $\mu$ F capacitors to ground, and 10  $\mu$ F capacitor should be connected between pins  $V_{RP}$  and  $V_{RN}$ .

**Using a clock source with excessive jitter, using excessively long clock signal trace, or having other signals coupled to the clock signal trace.** This will cause the sampling interval to vary, causing excessive output noise and a reduction in SNR and SINAD performance.

**Physical Dimensions** inches (millimeters) unless otherwise noted

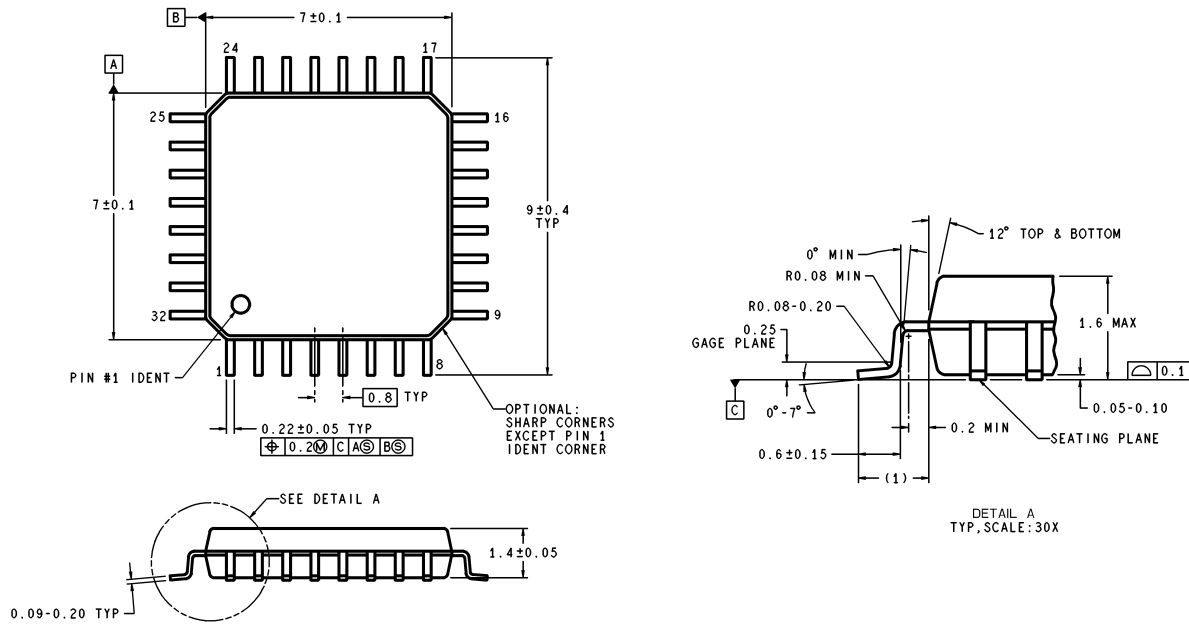

DIMENSIONS ARE IN MILLIMETERS

VBE32A (Rev E)

**32-Lead LQFP Package**  
**Ordering Number ADC14L040CIVY**  
**NS Package Number VBE32A**

National does not assume any responsibility for use of any circuitry described, no circuit patent licenses are implied and National reserves the right at any time without notice to change said circuitry and specifications.

For the most current product information visit us at [www.national.com](http://www.national.com).

**LIFE SUPPORT POLICY**

NATIONAL'S PRODUCTS ARE NOT AUTHORIZED FOR USE AS CRITICAL COMPONENTS IN LIFE SUPPORT DEVICES OR SYSTEMS WITHOUT THE EXPRESS WRITTEN APPROVAL OF THE PRESIDENT AND GENERAL COUNSEL OF NATIONAL SEMICONDUCTOR CORPORATION. As used herein:

1. Life support devices or systems are devices or systems which, (a) are intended for surgical implant into the body, or (b) support or sustain life, and whose failure to perform when properly used in accordance with instructions for use provided in the labeling, can be reasonably expected to result in a significant injury to the user.
2. A critical component is any component of a life support device or system whose failure to perform can be reasonably expected to cause the failure of the life support device or system, or to affect its safety or effectiveness.

**BANNED SUBSTANCE COMPLIANCE**

National Semiconductor manufactures products and uses packing materials that meet the provisions of the Customer Products Stewardship Specification (CSP-9-111C2) and the Banned Substances and Materials of Interest Specification (CSP-9-111S2) and contain no "Banned Substances" as defined in CSP-9-111S2.

Leadfree products are RoHS compliant.



**National Semiconductor**  
**Americas Customer**  
**Support Center**  
 Email: [new.feedback@nsc.com](mailto:new.feedback@nsc.com)  
 Tel: 1-800-272-9959

**National Semiconductor**  
**Europe Customer Support Center**  
 Fax: +49 (0) 180-530 85 86  
 Email: [europe.support@nsc.com](mailto:europe.support@nsc.com)  
 Deutsch Tel: +49 (0) 69 9508 6208  
 English Tel: +44 (0) 870 24 0 2171  
 Français Tel: +33 (0) 1 41 91 8790

**National Semiconductor**  
**Asia Pacific Customer**  
**Support Center**  
 Email: [ap.support@nsc.com](mailto:ap.support@nsc.com)

**National Semiconductor**  
**Japan Customer Support Center**  
 Fax: 81-3-5639-7507  
 Email: [jpn.feedback@nsc.com](mailto:jpn.feedback@nsc.com)  
 Tel: 81-3-5639-7560