

## ADC128S052, ADC128S052-Q1 8-Channel, 200 kSPS to 500 kSPS, 12-Bit A/D Converter

### 1 Features

- Qualified for Automotive Applications
- AEC-Q100 Qualified With the Following Results:
  - Device Temperature Grade 1:  $-40^{\circ}\text{C}$  to  $+125^{\circ}\text{C}$  Ambient Operating Temperature Range
- Eight Input Channels
- Variable Power Management
- Independent Analog and Digital Supplies
- Compatible With SPI™, QSPI™, MICROWIRE, and DSP
- Packaged in 16-Pin TSSOP
- Conversion Rate 200 kSPS to 500 kSPS
- DNL ( $V_A = V_D = 5\text{ V}$ ) + 1.3 or  $-0.9$  LSB (Maximum)
- INL ( $V_A = V_D = 5\text{ V}$ )  $\pm 1$  LSB (Maximum)
- Power Consumption
  - 3-V Supply 1.6 mW (Typical)
  - 5-V Supply 8.7 mW (Typical)

### 2 Applications

- Automotive Navigation
- Portable Systems
- Medical Instruments
- Mobile Communications
- Instrumentation and Control Systems

### 3 Description

The ADC128S052x device is a low-power, eight-channel CMOS 12-bit analog-to-digital converter specified for conversion throughput rates of 200 kSPS to 500 kSPS. The converter is based on a successive-approximation register architecture with an internal track-and-hold circuit. It can be configured to accept up to eight input signals at inputs IN0 through IN7.

The output serial data is straight binary and is compatible with several standards, such as SPI, QSPI, MICROWIRE, and many common DSP serial interfaces.

The ADC128S052x may be operated with independent analog and digital supplies. The analog supply ( $V_A$ ) can range from 2.7 V to 5.25 V, and the digital supply ( $V_D$ ) can range from 2.7 V to  $V_A$ . Normal power consumption using a 3-V or 5-V supply is 1.6 mW and 8.7 mW, respectively. The power-down feature reduces the power consumption to 0.06  $\mu\text{W}$  using a 3-V supply and 0.25  $\mu\text{W}$  using a 5-V supply.

The ADC128S052x is packaged in a 16-pin TSSOP package. The ADC128S052 is ensured over the extended industrial temperature range of  $-40^{\circ}\text{C}$  to  $+105^{\circ}\text{C}$  while the ADC128S052-Q1 is ensured to an AECQ100 Grade-1 automotive temperature range of  $-40^{\circ}\text{C}$  to  $+125^{\circ}\text{C}$ .

#### Device Information<sup>(1)</sup>

PART NUMBER	PACKAGE	BODY SIZE (NOM)
ADC128S052, ADC128S052-Q1	TSSOP (16)	4.40 mm x 5.00 mm

(1) For all available packages, see the orderable addendum at the end of the data sheet.

#### Simplified Schematic

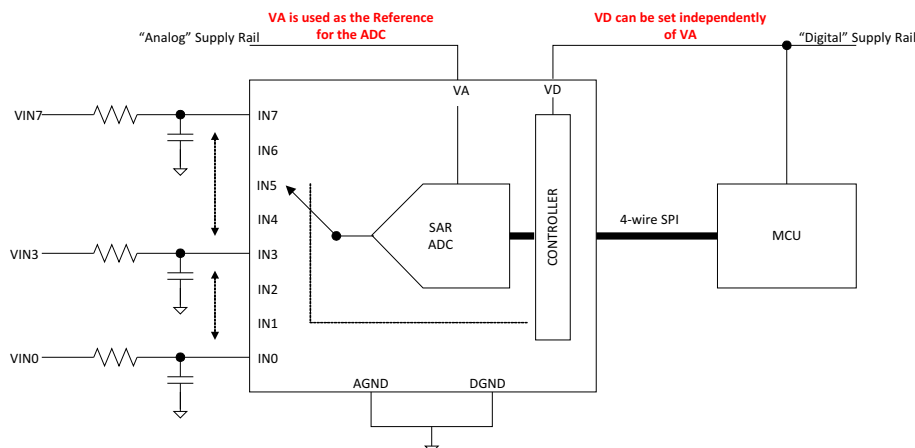

## Table of Contents

<b>1 Features</b> .....	1	7.5 Programming.....	17
<b>2 Applications</b> .....	1	7.6 Register Maps .....	18
<b>3 Description</b> .....	1	<b>8 Application and Implementation</b> .....	19
<b>4 Revision History</b> .....	2	8.1 Application Information.....	19
<b>5 Pin Configuration and Functions</b> .....	3	8.2 Typical Application .....	20
<b>6 Specifications</b> .....	4	<b>9 Power Supply Recommendations</b> .....	22
6.1 Absolute Maximum Ratings .....	4	9.1 Power Supply Sequence.....	22
6.2 ESD Ratings – Commercial .....	4	9.2 Power Supply Noise Considerations.....	22
6.3 ESD Ratings – Automotive .....	4	<b>10 Layout</b> .....	23
6.4 Recommended Operating Conditions .....	5	10.1 Layout Guidelines .....	23
6.5 Thermal Information .....	5	10.2 Layout Example .....	23
6.6 Electrical Characteristics .....	5	<b>11 Device and Documentation Support</b> .....	24
6.7 Timing Specifications .....	8	11.1 Device Support .....	24
6.8 Typical Characteristics .....	9	11.2 Related Links .....	25
<b>7 Detailed Description</b> .....	15	11.3 Community Resources.....	26
7.1 Overview .....	15	11.4 Trademarks .....	26
7.2 Functional Block Diagram .....	15	11.5 Electrostatic Discharge Caution.....	26
7.3 Feature Description.....	15	11.6 Glossary .....	26
7.4 Device Functional Modes.....	16	<b>12 Mechanical, Packaging, and Orderable Information</b> .....	26

## 4 Revision History

NOTE: Page numbers for previous revisions may differ from page numbers in the current version.

<b>Changes from Revision D (March 2013) to Revision E</b>	<b>Page</b>
<ul style="list-style-type: none"> <li>Added <i>Device Information</i> table, <i>ESD Ratings</i> table, <i>Thermal Information</i> table, <i>Feature Description</i> section, <i>Device Functional Modes</i>, <i>Application and Implementation</i> section, <i>Power Supply Recommendations</i> section, <i>Layout</i> section, <i>Device and Documentation Support</i> section, and <i>Mechanical, Packaging, and Orderable Information</i> section.....</li> </ul>	<b>1</b>

<b>Changes from Revision C (March 2013) to Revision D</b>	<b>Page</b>
<ul style="list-style-type: none"> <li>Changed layout of National Data Sheet to TI format .....</li> </ul>	<b>23</b>

## 5 Pin Configuration and Functions

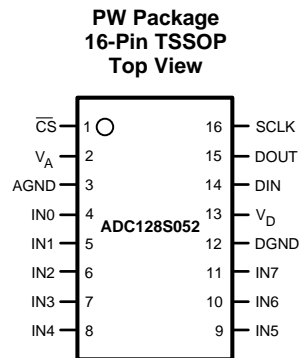

### Pin Functions

PIN		TYPE	DESCRIPTION
NO.	NAME		
1	$\overline{CS}$	Digital I/O	Chip select. On the falling edge of $\overline{CS}$ , a conversion process begins. Conversions continue as long as $\overline{CS}$ is held low.
2	$V_A$	Power Supply	Positive analog supply pin. This voltage is also used as the reference voltage. This pin must be connected to a quiet 2.7-V to 5.25-V source and bypassed to GND with 1- $\mu$ F and 0.1- $\mu$ F monolithic ceramic capacitors located within 1 cm of the power pin.
3	AGND	Power Supply	The ground return for the analog supply and signals.
4	IN0 to IN7	Analog I/O	Analog inputs. These signals can range from 0 V to $V_{REF}$ .
5			
6			
7			
8			
9			
10			
11			
12	DGND	Power Supply	The ground return for the digital supply and signals.
13	$V_D$	Power Supply	Positive digital supply pin. This pin must be connected to a 2.7-V to $V_A$ supply, and bypassed to GND with a 0.1- $\mu$ F monolithic ceramic capacitor located within 1 cm of the power pin.
14	DIN	Digital I/O	Digital data input. The control register of the ADC128S052 is loaded through this pin on rising edges of the SCLK pin.
15	DOUT	Digital I/O	Digital data output. The output samples are clocked out of this pin on the falling edges of the SCLK pin.
16	SCLK	Digital I/O	Digital clock input. The ensured performance range of frequencies for this input is 3.2 MHz to 8 MHz. This clock directly controls the conversion and readout processes.

## 6 Specifications

### 6.1 Absolute Maximum Ratings

 See <sup>(1)(2)(3)</sup>

	MIN	MAX	UNIT
Analog Supply Voltage $V_A$	-0.3	6.5	V
Digital Supply Voltage $V_D$	-0.3	$V_A + 0.3$ , max 6.5	V
Voltage on Any Pin to GND	-0.3	$V_A + 0.3$	V
Input Current at Any Pin <sup>(4)</sup>		$\pm 10$	mA
Package Input Current <sup>(4)</sup>		$\pm 20$	mA
Power Dissipation at $T_A = 25^\circ\text{C}$		See <sup>(5)</sup>	
Junction Temperature		+150	$^\circ\text{C}$
Storage Temperature, $T_{\text{stg}}$	-65	150	$^\circ\text{C}$

- Stresses beyond those listed under *Absolute Maximum Ratings* may cause permanent damage to the device. These are stress ratings only, which do not imply functional operation of the device at these or any other conditions beyond those indicated under *Recommended Operating Conditions*. Exposure to absolute-maximum-rated conditions for extended periods may affect device reliability.
- If Military/Aerospace specified devices are required, contact the TI Sales Office/Distributors for availability and specifications.
- For soldering specifications: see product folder at [www.ti.com](http://www.ti.com) and [SNOA549](#).
- When the input voltage at any pin exceeds the power supplies (that is,  $V_{\text{IN}} < \text{AGND}$  or  $V_{\text{IN}} > V_A$  or  $V_D$ ), the current at that pin must be limited to 10 mA. The 20-mA maximum package input current rating limits the number of pins that can safely exceed the power supplies with an input current of 10 mA to two.
- The absolute maximum junction temperature ( $T_{\text{JMAX}}$ ) for this device is  $150^\circ\text{C}$ . The maximum allowable power dissipation is dictated by  $T_{\text{JMAX}}$ , the junction-to-ambient thermal resistance ( $R_{\theta\text{JA}}$ ), and the ambient temperature ( $T_A$ ), and can be calculated using the formula  $P_{\text{DMAX}} = (T_{\text{JMAX}} - T_A)/R_{\theta\text{JA}}$ . In the 16-pin TSSOP,  $R_{\theta\text{JA}}$  is  $110^\circ\text{C}/\text{W}$ , so  $P_{\text{DMAX}} = 1,200 \text{ mW}$  at  $25^\circ\text{C}$  and  $625 \text{ mW}$  at the maximum operating ambient temperature of  $105^\circ\text{C}$ . Note that the power consumption of this device under normal operation is a maximum of 12 mW. The values for maximum power dissipation listed above is reached only when the ADC128S052 is operated in a severe fault condition (for example, when input or output pins are driven beyond the power supply voltages, or the power supply polarity is reversed). Such conditions must always be avoided.

### 6.2 ESD Ratings – Commercial

		VALUE	UNIT
$V_{\text{(ESD)}}$	Electrostatic discharge	Human body model (HBM), per ANSI/ESDA/JEDEC JS-001 <sup>(1)(2)</sup>	$\pm 2500$
		Machine model (MM) <sup>(3)</sup>	$\pm 250$

- JEDEC document JEP155 states that 500-V HBM allows safe manufacturing with a standard ESD control process.
- Human body model is a 100-pF capacitor discharged through a 1.5-k $\Omega$  resistor.
- Machine model is a 220-pF discharged through ZERO  $\Omega$ .

### 6.3 ESD Ratings – Automotive

		VALUE	UNIT
$V_{\text{(ESD)}}$	Electrostatic discharge	Human-body model (HBM), per AEC Q100-002 <sup>(1)</sup>	$\pm 2500$
		Charged-device model (CDM), per AEC Q100-011	$\pm 250$

- AEC Q100-002 indicates that HBM stressing shall be in accordance with the ANSI/ESDA/JEDEC JS-001 specification.

## 6.4 Recommended Operating Conditions

 See <sup>(1)</sup>

		MIN	NOM	MAX	UNIT
Operating Temperature	ADC128S052	-40	T <sub>A</sub>	105	°C
	ADC128S052-Q1	-40	T <sub>A</sub>	125	°C
V <sub>A</sub> Supply Voltage		2.7		5.25	V
V <sub>D</sub> Supply Voltage		2.7		V <sub>A</sub>	V
Digital Input Voltage		0		V <sub>A</sub>	V
Analog Input Voltage		0		V <sub>A</sub>	V
Clock Frequency		50		1600	kHz

<sup>(1)</sup> All voltages are measured with respect to GND = 0 V, unless otherwise specified.

## 6.5 Thermal Information

THERMAL METRIC <sup>(1)</sup>		ADC128S052, ADC128S052-Q1		UNIT
		PW (TSSOP)		
		16 PINS		
R <sub>θJA</sub>	Junction-to-ambient thermal resistance	110		°C/W
R <sub>θJC(top)</sub>	Junction-to-case (top) thermal resistance	42		°C/W
R <sub>θJB</sub>	Junction-to-board thermal resistance	56		°C/W
Ψ <sub>JT</sub>	Junction-to-top characterization parameter	5		°C/W
Ψ <sub>JB</sub>	Junction-to-board characterization parameter	55		°C/W

<sup>(1)</sup> For more information about traditional and new thermal metrics, see the *Semiconductor and IC Package Thermal Metrics* application report, [SPRA953](#).

## 6.6 Electrical Characteristics

 The following specifications apply for AGND = DGND = 0 V, f<sub>SCLK</sub> = 3.2 MHz to 8 MHz, f<sub>SAMPLE</sub> = 200 kSPS to 500 kSPS, C<sub>L</sub> = 50 pF, unless otherwise noted. Maximum and minimum limits apply for T<sub>A</sub> = T<sub>MIN</sub> to T<sub>MAX</sub>; all other limits T<sub>A</sub> = 25°C.<sup>(1)</sup>

PARAMETER	TEST CONDITIONS	MIN	TYP	MAX <sup>(2)</sup>	UNIT
<b>STATIC CONVERTER CHARACTERISTICS</b>					
	Resolution with No Missing Codes			12	Bits
INL	Integral Non-Linearity (End Point Method)	V <sub>A</sub> = V <sub>D</sub> = 3 V	±0.3	±1	LSB
		V <sub>A</sub> = V <sub>D</sub> = 5 V	±0.4	±1	LSB
DNL	Differential Non-Linearity	V <sub>A</sub> = V <sub>D</sub> = 3 V	-0.7	0.3	0.9
			-0.2		LSB
		V <sub>A</sub> = V <sub>D</sub> = 5 V		0.6	1.3
		-0.9	-0.4		LSB
V <sub>OFF</sub>	Offset Error	V <sub>A</sub> = V <sub>D</sub> = 3 V		0.8	±2.3
		V <sub>A</sub> = V <sub>D</sub> = 5 V		1.2	±2.3
OEM	Offset Error Match	V <sub>A</sub> = V <sub>D</sub> = 3 V		±0.05	±1.5
		V <sub>A</sub> = V <sub>D</sub> = 5 V		±0.2	±1.5
FSE	Full Scale Error	V <sub>A</sub> = V <sub>D</sub> = 3 V		0.6	±2.0
		V <sub>A</sub> = V <sub>D</sub> = 5 V		0.3	±2.0
FSEM	Full Scale Error Match	V <sub>A</sub> = V <sub>D</sub> = 3 V		±0.05	±1.5
		V <sub>A</sub> = V <sub>D</sub> = 5 V		±0.2	±1.5

<sup>(1)</sup> Data sheet minimum and maximum specification limits are ensured by design, test, or statistical analysis.

<sup>(2)</sup> Tested limits are ensured to TI's AOQL (Average Outgoing Quality Level).

**Electrical Characteristics (continued)**

The following specifications apply for AGND = DGND = 0 V,  $f_{SCLK} = 3.2 \text{ MHz to } 8 \text{ MHz}$ ,  $f_{SAMPLE} = 200 \text{ kSPS to } 500 \text{ kSPS}$ ,  $C_L = 50 \text{ pF}$ , unless otherwise noted. Maximum and minimum limits apply for  $T_A = T_{MIN}$  to  $T_{MAX}$ : all other limits  $T_A = 25^\circ\text{C}$ .<sup>(1)</sup>

PARAMETER		TEST CONDITIONS	MIN	TYP	MAX <sup>(2)</sup>	UNIT
<b>DYNAMIC CONVERTER CHARACTERISTICS</b>						
FPBW	Full Power Bandwidth (-3 dB)	$V_A = V_D = 3 \text{ V}$		8		MHz
		$V_A = V_D = 5 \text{ V}$		11		MHz
SINAD	Signal-to-Noise Plus Distortion Ratio	$V_A = V_D = 3 \text{ V}$ , $f_{IN} = 40.2 \text{ kHz}$ , -0.02 dBFS	70	73		dB
		$V_A = V_D = 5 \text{ V}$ , $f_{IN} = 40.2 \text{ kHz}$ , -0.02 dBFS	70	73		dB
SNR	Signal-to-Noise Ratio	$V_A = V_D = 3 \text{ V}$ , $f_{IN} = 40.2 \text{ kHz}$ , -0.02 dBFS	70.8	73		dB
		$V_A = V_D = 5 \text{ V}$ , $f_{IN} = 40.2 \text{ kHz}$ , -0.02 dBFS	70.8	73		dB
THD	Total Harmonic Distortion	$V_A = V_D = 3 \text{ V}$ , $f_{IN} = 40.2 \text{ kHz}$ , -0.02 dBFS		-90	-74	dB
		$V_A = V_D = 5 \text{ V}$ , $f_{IN} = 40.2 \text{ kHz}$ , -0.02 dBFS		-89	-74	dB
SFDR	Spurious-Free Dynamic Range	$V_A = V_D = 3 \text{ V}$ , $f_{IN} = 40.2 \text{ kHz}$ , -0.02 dBFS	75	92		dB
		$V_A = V_D = 5 \text{ V}$ , $f_{IN} = 40.2 \text{ kHz}$ , -0.02 dBFS	75	91		dB
ENOB	Effective Number of Bits	$V_A = V_D = 3 \text{ V}$ , $f_{IN} = 40.2 \text{ kHz}$	11.3	11.8		Bits
		$V_A = V_D = 5 \text{ V}$ , $f_{IN} = 40.2 \text{ kHz}$ , -0.02 dBFS	11.3	11.8		Bits
ISO	Channel-to-Channel Isolation	$V_A = V_D = 3 \text{ V}$ , $f_{IN} = 20 \text{ kHz}$		81		dB
		$V_A = V_D = 5 \text{ V}$ , $f_{IN} = 20 \text{ kHz}$ , -0.02 dBFS		81		dB
IMD	Intermodulation Distortion, Second Order Terms	$V_A = V_D = 3 \text{ V}$ , $f_a = 19.5 \text{ kHz}$ , $f_b = 20.5 \text{ kHz}$		-98		dB
		$V_A = V_D = 5 \text{ V}$ , $f_a = 19.5 \text{ kHz}$ , $f_b = 20.5 \text{ kHz}$		-91		dB
	Intermodulation Distortion, Third Order Terms	$V_A = V_D = 3 \text{ V}$ , $f_a = 19.5 \text{ kHz}$ , $f_b = 20.5 \text{ kHz}$		-89		dB
		$V_A = V_D = 5 \text{ V}$ , $f_a = 19.5 \text{ kHz}$ , $f_b = 20.5 \text{ kHz}$		-88		dB
<b>ANALOG INPUT CHARACTERISTICS</b>						
$V_{IN}$	Input Range		0		$V_A$	V
$I_{DCL}$	DC Leakage Current				±1	µA
$C_{INA}$	Input Capacitance	Track Mode		33		pF
		Hold Mode		3		pF
<b>DIGITAL INPUT CHARACTERISTICS</b>						
$V_{IH}$	Input High Voltage	$V_A = V_D = 2.7 \text{ V to } 3.6 \text{ V}$	2.1			V
		$V_A = V_D = 4.75 \text{ V to } 5.25 \text{ V}$	2.4			V
$V_{IL}$	Input Low Voltage	$V_A = V_D = 2.7 \text{ V to } 5.25 \text{ V}$			0.8	V
$I_{IN}$	Input Current	$V_{IN} = 0 \text{ V or } V_D$		±0.01	±1	µA
$C_{IND}$	Digital Input Capacitance			2	4	pF

## Electrical Characteristics (continued)

The following specifications apply for AGND = DGND = 0 V,  $f_{SCLK} = 3.2$  MHz to 8 MHz,  $f_{SAMPLE} = 200$  kSPS to 500 kSPS,  $C_L = 50$  pF, unless otherwise noted. Maximum and minimum limits apply for  $T_A = T_{MIN}$  to  $T_{MAX}$ ; all other limits  $T_A = 25^\circ\text{C}$ .<sup>(1)</sup>

PARAMETER		TEST CONDITIONS	MIN	TYP	MAX <sup>(2)</sup>	UNIT
<b>DIGITAL OUTPUT CHARACTERISTICS</b>						
$V_{OH}$	Output High Voltage	$I_{SOURCE} = 200 \mu\text{A}$ , $V_A = V_D = 2.7 \text{ V to } 5.25 \text{ V}$	$V_D - 0.5$			V
$V_{OL}$	Output Low Voltage	$I_{SINK} = 200 \mu\text{A to } 1.0 \text{ mA}$ , $V_A = V_D = 2.7 \text{ V to } 5.25 \text{ V}$			0.4	V
$I_{OZH}$ , $I_{OZL}$	Hi-Impedance Output Leakage Current	$V_A = V_D = 2.7 \text{ V to } 5.25 \text{ V}$			$\pm 1$	$\mu\text{A}$
$C_{OUT}$	Hi-Impedance Output Capacitance <sup>(1)</sup>			2	4	pF
	Output Coding		Straight (Natural) Binary			
<b>POWER SUPPLY CHARACTERISTICS (<math>C_L = 10</math> pF)</b>						
$V_A, V_D$	Analog and Digital Supply Voltages	$V_A \geq V_D$	2.7		5.25	V
$I_A + I_D$	Total Supply Current Normal Mode ( $\overline{CS}$ low)	$V_A = V_D = 2.7 \text{ V to } 3.6 \text{ V}$ , $f_{SAMPLE} = 500 \text{ kSPS}$ , $f_{IN} = 40 \text{ kHz}$		0.54	1.2	mA
		$V_A = V_D = 4.75 \text{ V to } 5.25 \text{ V}$ , $f_{SAMPLE} = 500 \text{ kSPS}$ , $f_{IN} = 40 \text{ kHz}$		1.74	2.6	mA
	Total Supply Current Shutdown Mode ( $\overline{CS}$ high)	$V_A = V_D = 2.7 \text{ V to } 3.6 \text{ V}$ , $f_{SCLK} = 0 \text{ kSPS}$		20		nA
		$V_A = V_D = 4.75 \text{ V to } 5.25 \text{ V}$ , $f_{SCLK} = 0 \text{ kSPS}$		50		nA
$P_C$	Power Consumption Normal Mode ( $\overline{CS}$ low)	$V_A = V_D = 3 \text{ V}$ , $f_{SAMPLE} = 500 \text{ kSPS}$ , $f_{IN} = 40 \text{ kHz}$		1.6	3.6	mW
		$V_A = V_D = 5.0 \text{ V}$ , $f_{SAMPLE} = 500 \text{ kSPS}$ , $f_{IN} = 40 \text{ kHz}$		8.7	13.0	mW
	Power Consumption Shutdown Mode ( $\overline{CS}$ high)	$V_A = V_D = 3 \text{ V}$ , $f_{SCLK} = 0 \text{ kSPS}$		0.06		$\mu\text{W}$
		$V_A = V_D = 5 \text{ V}$ , $f_{SCLK} = 0 \text{ kSPS}$		0.25		$\mu\text{W}$
<b>AC ELECTRICAL CHARACTERISTICS</b>						
$f_{SCLK}^{MIN}$	Minimum Clock Frequency	$V_A = V_D = 2.7 \text{ V to } 5.25 \text{ V}$	3.2	0.8		MHz
$f_{SCLK}$	Maximum Clock Frequency	$V_A = V_D = 2.7 \text{ V to } 5.25 \text{ V}$		16	8	MHz
$f_S$	Sample Rate Continuous Mode	$V_A = V_D = 2.7 \text{ V to } 5.25 \text{ V}$	200	50		kSPS
				1000	500	kSPS
$t_{CONVERT}$	Conversion (Hold) Time	$V_A = V_D = 2.7 \text{ V to } 5.25 \text{ V}$			13	SCLK cycles
DC	SCLK Duty Cycle	$V_A = V_D = 2.7 \text{ V to } 5.25 \text{ V}$	40%	30%		
				70%	60%	
$t_{ACQ}$	Acquisition (Track) Time	$V_A = V_D = 2.7 \text{ V to } 5.25 \text{ V}$			3	SCLK cycles
	Throughput Time	Acquisition Time + Conversion Time $V_A = V_D = 2.7 \text{ V to } 5.25 \text{ V}$			16	SCLK cycles
$t_{AD}$	Aperture Delay	$V_A = V_D = 2.7 \text{ V to } 5.25 \text{ V}$		4		ns

## 6.7 Timing Specifications

The following specifications apply for  $V_A = V_D = 2.7\text{ V}$  to  $5.25\text{ V}$ ,  $AGND = DGND = 0\text{ V}$ ,  $f_{SCLK} = 3.2\text{ MHz}$  to  $8\text{ MHz}$ ,  $f_{SAMPLE} = 200\text{ kSPS}$  to  $500\text{ kSPS}$ , and  $C_L = 50\text{ pF}$ . Maximum and minimum limits apply for  $T_A = T_{MIN}$  to  $T_{MAX}$ ; all other limits  $T_A = 25^\circ\text{C}$ . See [Figure 1](#), [Figure 2](#), and [Figure 3](#).

		MIN	NOM	MAX <sup>(1)</sup>	UNIT
$t_{CSH}$	$\overline{CS}$ Hold Time after SCLK Rising Edge	10	0		ns
$t_{CSS}$	$\overline{CS}$ Set-up Time prior to SCLK Rising Edge	10	4.5		ns
$t_{EN}$	$\overline{CS}$ Falling Edge to DOUT enabled		5	30	ns
$t_{DACC}$	DOUT Access Time after SCLK Falling Edge		17	27	ns
$t_{DHL D}$	DOUT Hold Time after SCLK Falling Edge		4		ns
$t_{DS}$	DIN Set-up Time prior to SCLK Rising Edge	10	3		ns
$t_{DH}$	DIN Hold Time after SCLK Rising Edge	10	3		ns
$t_{CH}$	SCLK High Time	$0.4 \times t_{SCLK}$			ns
$t_{CL}$	SCLK Low Time	$0.4 \times t_{SCLK}$			ns
$t_{DIS}$	$\overline{CS}$ Rising Edge to DOUT High-Impedance	DOUT falling	2.4	20	ns
		DOUT rising	0.9	20	ns

(1) Tested limits are ensured to TI's AOQL (Average Outgoing Quality Level).

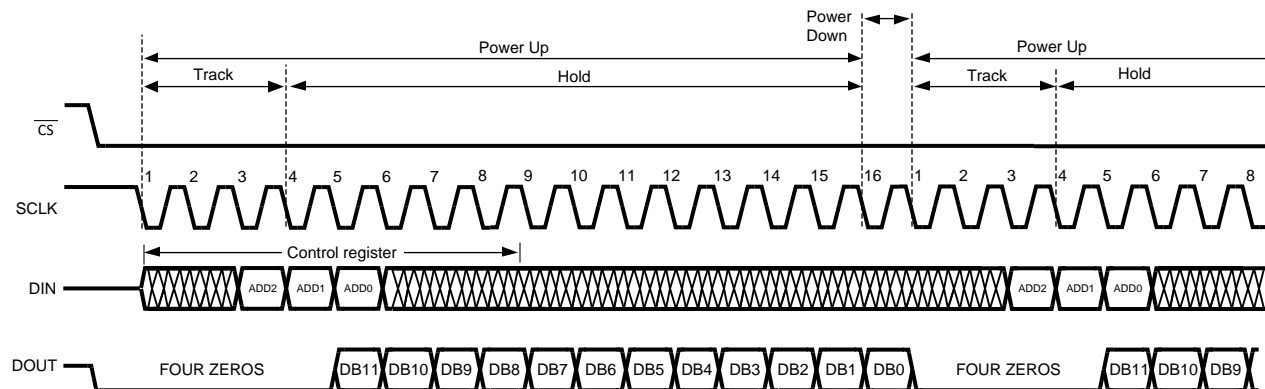

**Figure 1. ADC128S052 Operational Timing Diagram**

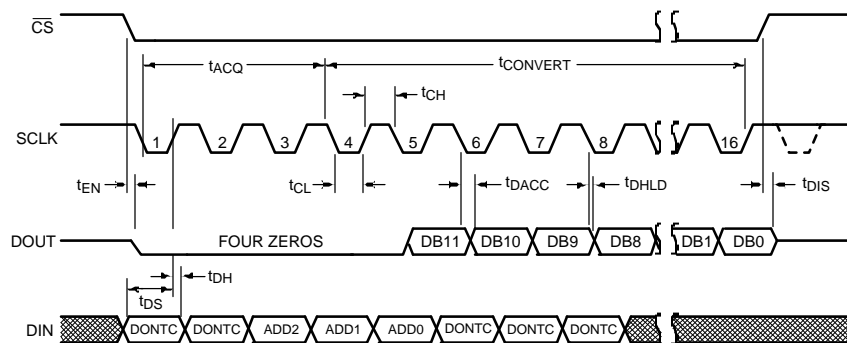

**Figure 2. ADC128S052 Serial Timing Diagram**



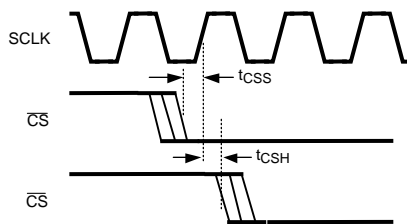
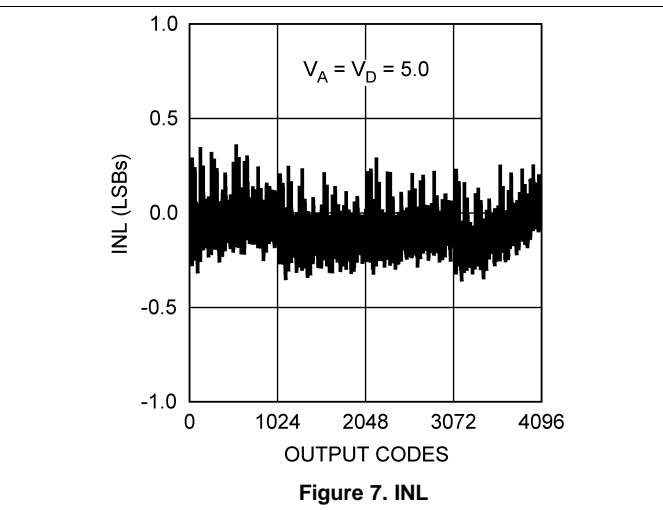
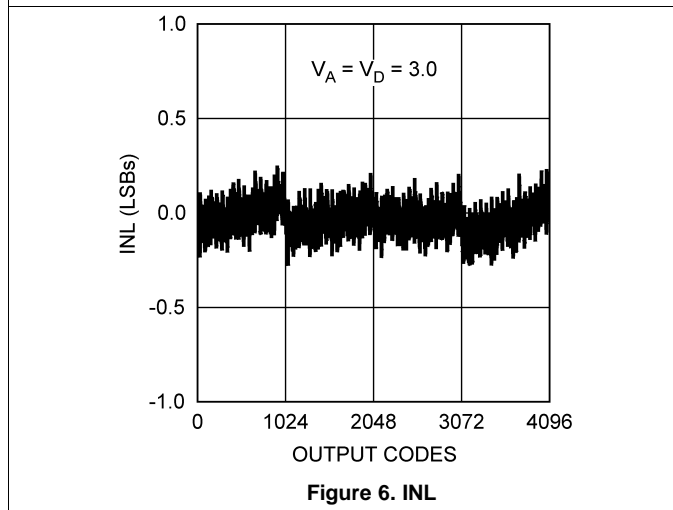
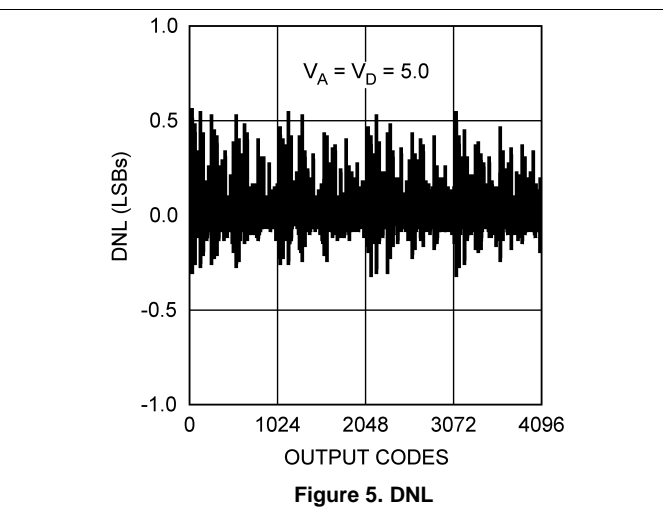
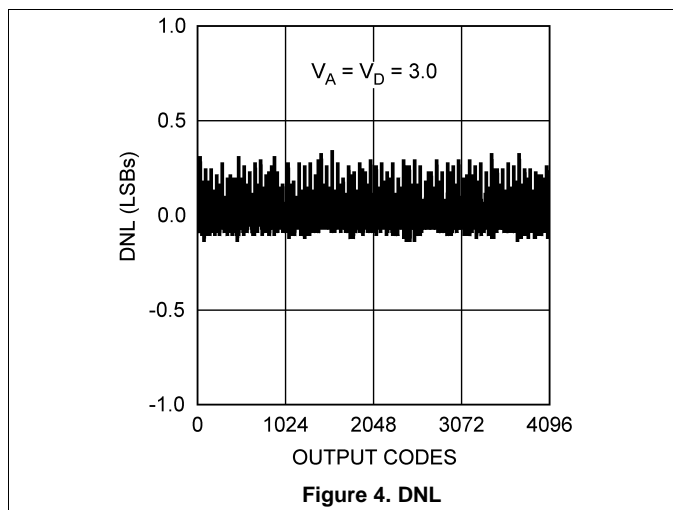
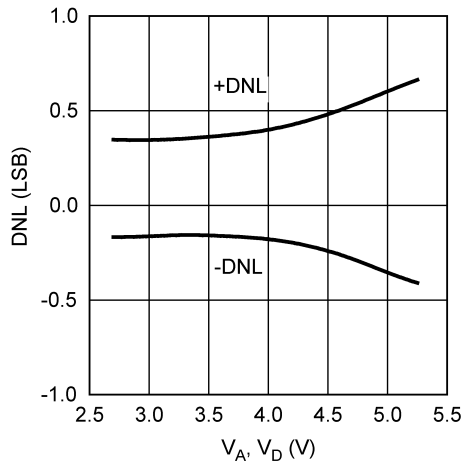
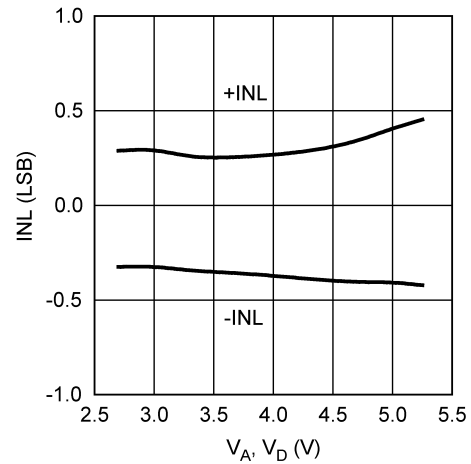
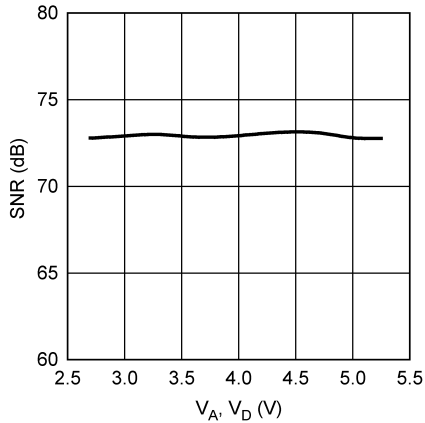
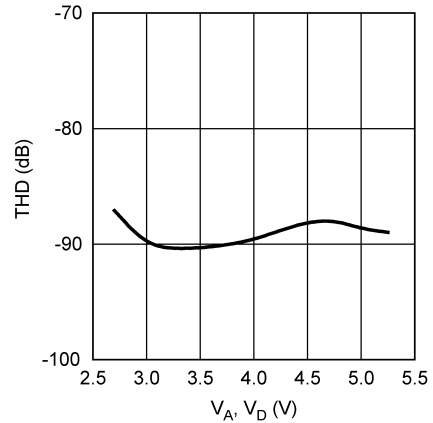
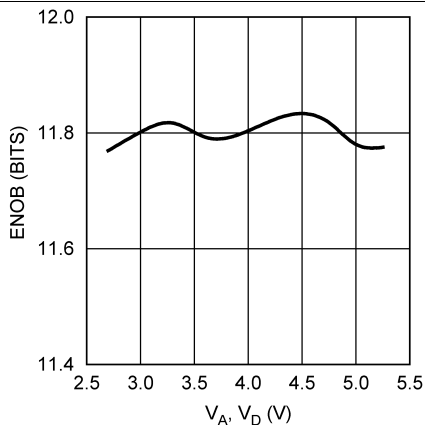
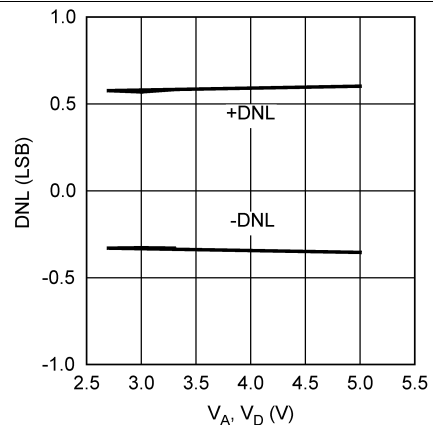

Figure 3. SCLK and CS Timing Parameters

### 6.8 Typical Characteristics

$T_A = 25^\circ\text{C}$ ,  $f_{\text{SAMPLE}} = 500 \text{ kSPS}$ ,  $f_{\text{SCLK}} = 8 \text{ MHz}$ ,  $f_{\text{IN}} = 40.2 \text{ kHz}$  unless otherwise stated



**Typical Characteristics (continued)**
 $T_A = 25^\circ\text{C}$ ,  $f_{\text{SAMPLE}} = 500 \text{ kSPS}$ ,  $f_{\text{SCLK}} = 8 \text{ MHz}$ ,  $f_{\text{IN}} = 40.2 \text{ kHz}$  unless otherwise stated

**Figure 8. DNL vs Supply**

**Figure 9. INL vs Supply**

**Figure 10. SNR vs Supply**

**Figure 11. THD vs Supply**

**Figure 12. ENOB vs Supply**

**Figure 13. DNL vs  $V_D$**

Typical Characteristics (continued)

$T_A = 25^\circ\text{C}$ ,  $f_{\text{SAMPLE}} = 500 \text{ kSPS}$ ,  $f_{\text{SCLK}} = 8 \text{ MHz}$ ,  $f_{\text{IN}} = 40.2 \text{ kHz}$  unless otherwise stated

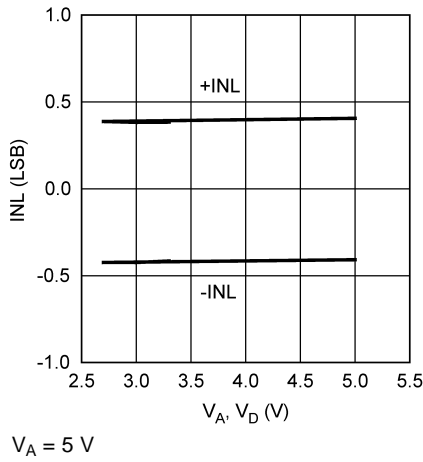

Figure 14. INL vs  $V_D$

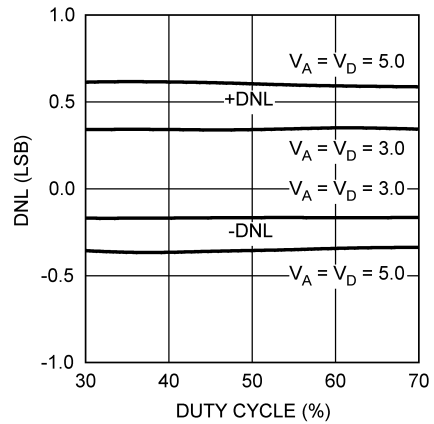

Figure 15. DNL vs SCLK Duty Cycle

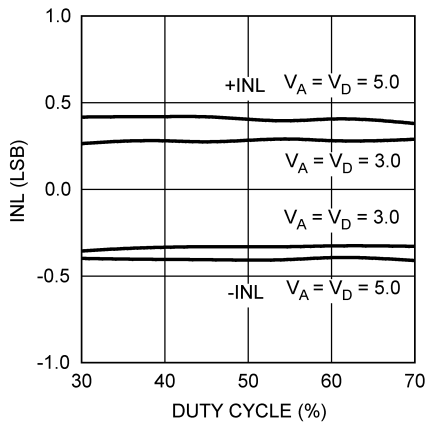

Figure 16. INL vs SCLK Duty Cycle

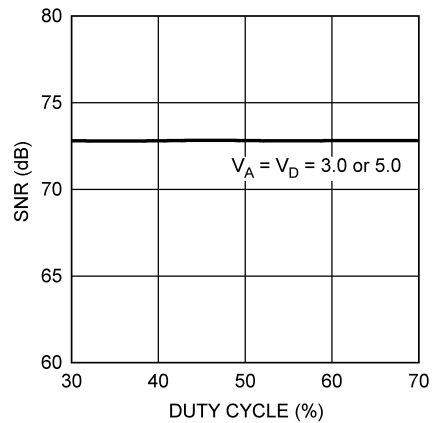

Figure 17. SNR vs SCLK Duty Cycle

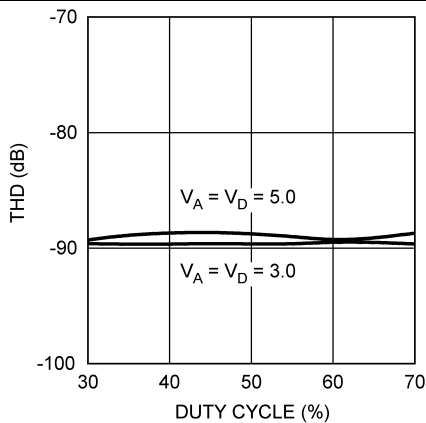

Figure 18. THD vs SCLK Duty Cycle

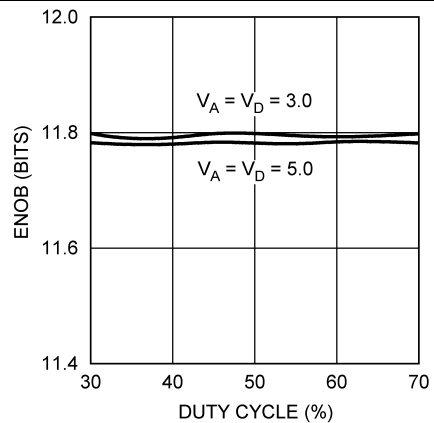
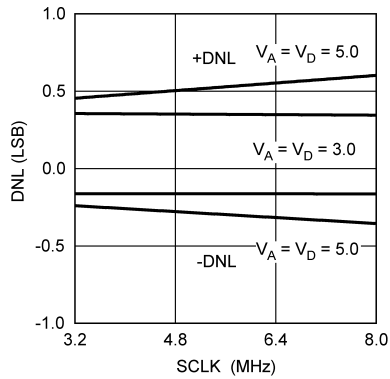
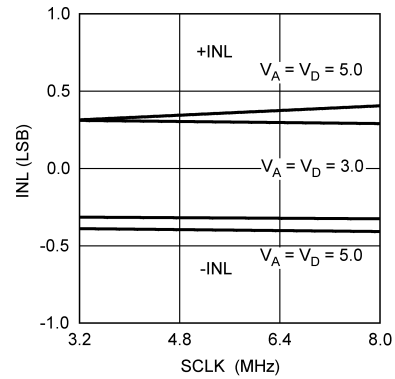
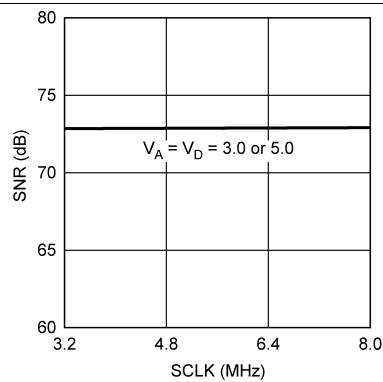
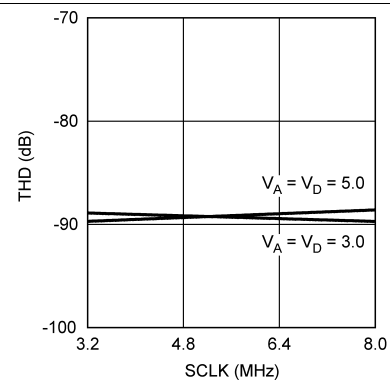
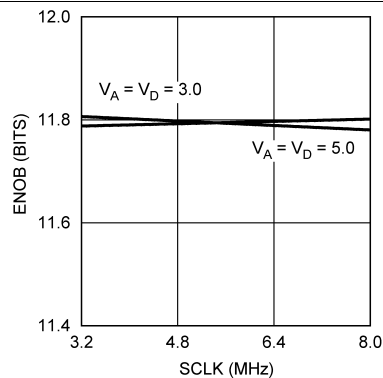
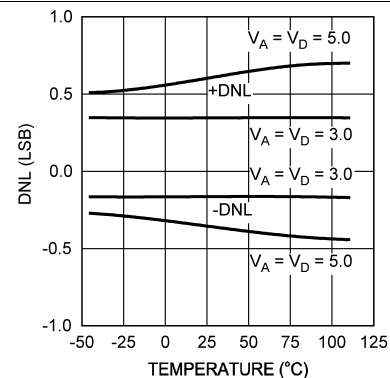

Figure 19. ENOB vs SCLK Duty Cycle

**Typical Characteristics (continued)**
 $T_A = 25^\circ\text{C}$ ,  $f_{\text{SAMPLE}} = 500 \text{ kSPS}$ ,  $f_{\text{SCLK}} = 8 \text{ MHz}$ ,  $f_{\text{IN}} = 40.2 \text{ kHz}$  unless otherwise stated

**Figure 20. DNL vs SCLK**

**Figure 21. INL vs SCLK**

**Figure 22. SNR vs SCLK**

**Figure 23. THD vs SCLK**

**Figure 24. ENOB vs SCLK**

**Figure 25. DNL vs Temperature**

Typical Characteristics (continued)

$T_A = 25^\circ\text{C}$ ,  $f_{\text{SAMPLE}} = 500 \text{ kSPS}$ ,  $f_{\text{SCLK}} = 8 \text{ MHz}$ ,  $f_{\text{IN}} = 40.2 \text{ kHz}$  unless otherwise stated

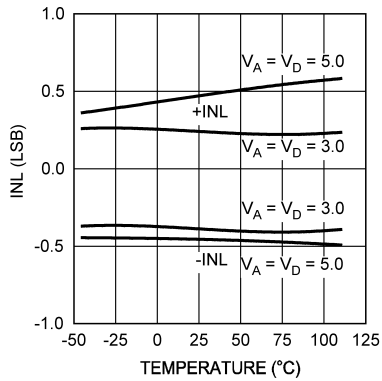

Figure 26. INL vs Temperature

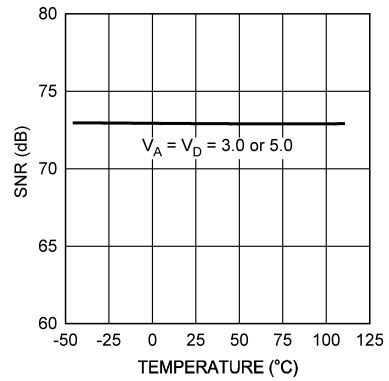

Figure 27. SNR vs Temperature

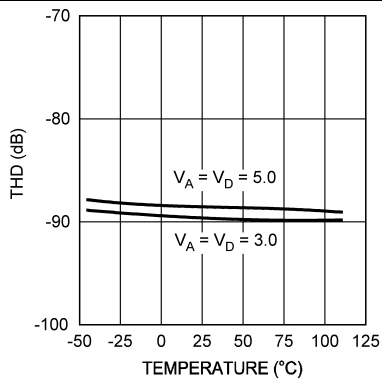

Figure 28. THD vs Temperature

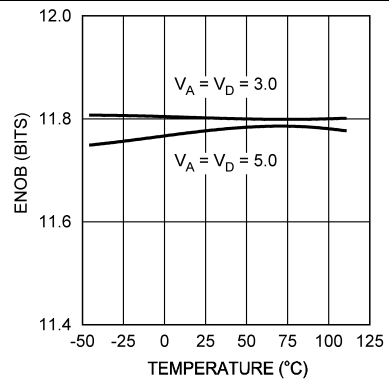

Figure 29. ENOB vs Temperature

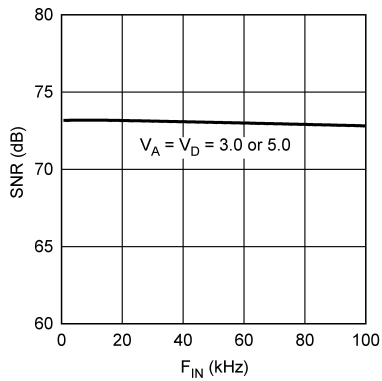

Figure 30. SNR vs Input Frequency

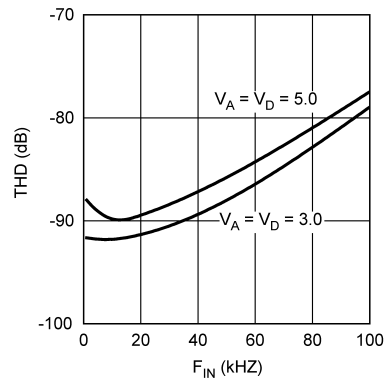

Figure 31. THD vs Input Frequency

Typical Characteristics (continued)

$T_A = 25^\circ\text{C}$ ,  $f_{\text{SAMPLE}} = 500 \text{ kSPS}$ ,  $f_{\text{SCLK}} = 8 \text{ MHz}$ ,  $f_{\text{IN}} = 40.2 \text{ kHz}$  unless otherwise stated

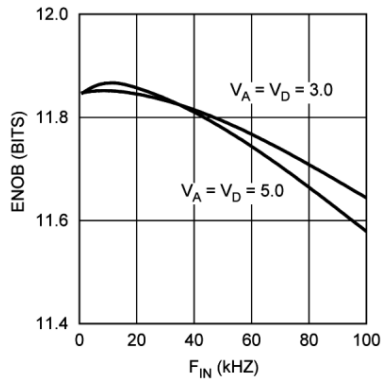

Figure 32. ENOB vs Input Frequency

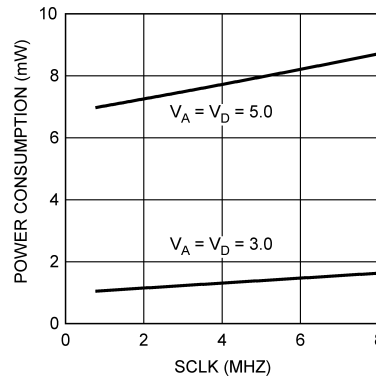

Figure 33. Power Consumption vs SCLK

## 7 Detailed Description

### 7.1 Overview

The ADC128S052x is a successive-approximation analog-to-digital converter designed around a charge-redistribution digital-to-analog converter. For the remainder of this document, ADC128S052x is abbreviated to ADC128S052.

### 7.2 Functional Block Diagram

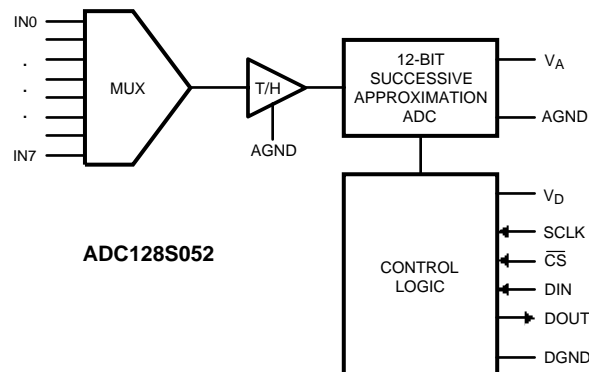

### 7.3 Feature Description

#### 7.3.1 Operation

Simplified schematics of the ADC128S052 in both track and hold operation are shown in [Figure 34](#) and [Figure 35](#), respectively. In [Figure 34](#), the ADC128S052 is in track mode: switch SW1 connects the sampling capacitor to one of eight analog input channels through the multiplexer, and SW2 balances the comparator inputs. The ADC128S052 is in this state for the first three SCLK cycles after CS is brought low.

[Figure 35](#) shows the ADC128S052 in hold mode: switch SW1 connects the sampling capacitor to ground, maintaining the sampled voltage, and switch SW2 unbalances the comparator. The control logic then instructs the charge-redistribution DAC to add or subtract fixed amounts of charge to or from the sampling capacitor until the comparator is balanced. When the comparator is balanced, the digital word supplied to the DAC is the digital representation of the analog input voltage. The ADC128S052 is in this state for the last thirteen SCLK cycles after CS is brought low.

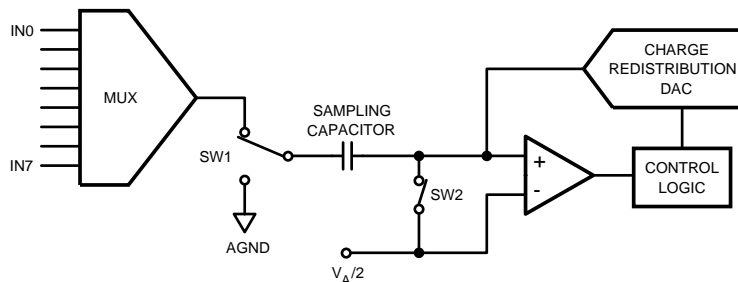
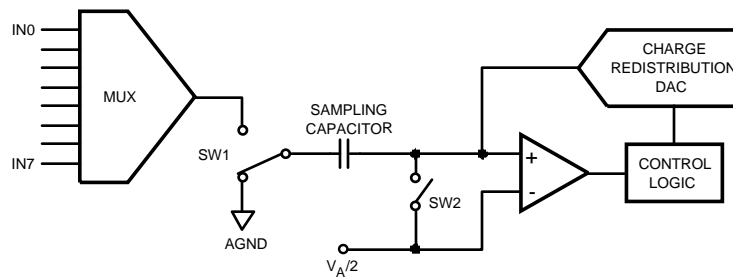

Figure 34. ADC128S052 in Track Mode

## Feature Description (continued)



**Figure 35. ADC128S052 in Hold Mode**

### 7.3.2 Transfer Function

The output format of the ADC128S052 is straight binary. Code transitions occur midway between successive integer LSB values. The LSB width for the ADC128S052 is  $V_A / 4096$ . The ideal transfer characteristic is shown in Figure 36. The transition from an output code of 0000 0000 0000 to a code of 0000 0000 0001 is at  $1/2$  LSB, or a voltage of  $V_A / 8192$ . Other code transitions occur at steps of one LSB.

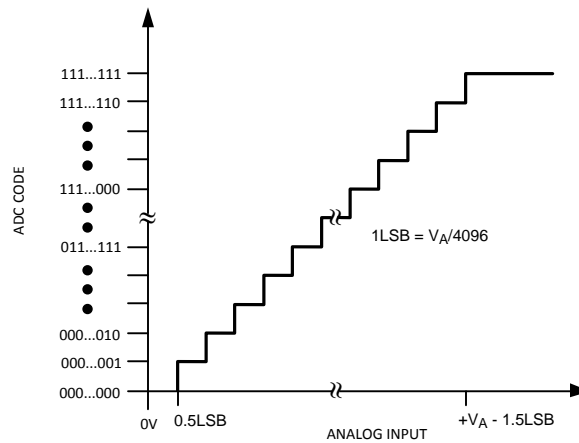

**Figure 36. Ideal Transfer Characteristic**

## 7.4 Device Functional Modes

The ADC128S052 is fully powered up whenever  $\overline{CS}$  is low and fully powered down whenever  $\overline{CS}$  is high, with one exception. If operating in continuous conversion mode, the ADC128S052 automatically enters power-down mode between the SCLK 16th falling edge of a conversion and the SCLK 1st falling edge of the subsequent conversion (see Figure 1).

In continuous conversion mode, the ADC128S052 can perform multiple conversions back-to-back. Each conversion requires 16 SCLK cycles, and the ADC128S052 performs conversions continuously as long as  $\overline{CS}$  is held low. Continuous mode offers maximum throughput.



## Device Functional Modes (continued)

In burst mode, the user may trade off throughput for power consumption by performing fewer conversions per unit time. This means spending more time in power-down mode and less time in normal mode. By utilizing this technique, the user can achieve very low sample rates while still utilizing an SCLK frequency within the electrical specifications. [Figure 33](#) in the *Typical Characteristics* section shows the typical power consumption of the ADC128S052. To calculate the power consumption ( $P_C$ ), simply multiply the fraction of time spent in the normal mode ( $t_N$ ) by the normal mode power consumption ( $P_N$ ), and add the fraction of time spent in shutdown mode ( $t_S$ ) multiplied by the shutdown mode power consumption ( $P_S$ ) as shown in [Equation 1](#).

$$P_C = \frac{t_N}{t_N + t_S} \times P_N + \frac{t_S}{t_N + t_S} \times P_S \quad (1)$$

## 7.5 Programming

### 7.5.1 Serial Interface

[Figure 1](#) shows a operational timing diagram, and [Figure 2](#) shows a serial interface timing diagram for the ADC128S052.  $\overline{CS}$  (chip select) initiates conversions and frames the serial data transfers. SCLK (serial clock) controls both the conversion process and the timing of serial data. DOUT is the serial data output pin, where a conversion result is sent as a serial data stream, MSB first. Data to be written to the control register of the device is placed on DIN, the serial data input pin. New data is written to DIN with each conversion.

A serial frame is initiated on the falling edge of  $\overline{CS}$  and ends on the rising edge of  $\overline{CS}$ . Each frame must contain an integer multiple of 16 rising SCLK edges. The ADC's DOUT pin is in a high impedance state when  $\overline{CS}$  is high and is active when  $\overline{CS}$  is low. Thus,  $\overline{CS}$  acts as an output enable. Similarly, SCLK is internally gated off when  $\overline{CS}$  is brought high.

During the first 3 cycles of SCLK, the ADC is in the track mode, acquiring the input voltage. For the next 13 SCLK cycles the conversion is accomplished, and the data is clocked out. SCLK falling edges 1 through 4 clock out leading zeros while falling edges 5 through 16 clock out the conversion result, MSB first. If there is more than one conversion in a frame (continuous conversion mode), the ADC re-enters the track mode on the falling edge of SCLK after the  $N \times 16$ th rising edge of SCLK and re-enter the hold/convert mode on the  $N \times 16 + 4$ th falling edge of SCLK.  $N$  is an integer value.

The ADC128S052 enters track mode under three different conditions. In [Figure 1](#),  $\overline{CS}$  goes low with SCLK high, and the ADC enters track mode on the first falling edge of SCLK. In the second condition,  $\overline{CS}$  goes low with SCLK low. Under this condition, the ADC automatically enters track mode and the falling edge of  $\overline{CS}$  is seen as the first falling edge of SCLK. In the third condition,  $\overline{CS}$  and SCLK go low simultaneously, and the ADC enters track mode. While there is no timing restriction with respect to the rising edges of  $\overline{CS}$  and SCLK, see [Figure 3](#) for setup and hold time requirements for the falling edge of  $\overline{CS}$  with respect to the rising edge of SCLK.

While a conversion is in progress, the address of the next input for conversion is clocked into a control register through the DIN pin on the first 8 rising edges of SCLK after the fall of  $\overline{CS}$ . See [Table 1](#), [Table 2](#), [Table 3](#).

There is no need to incorporate a power-up delay or dummy conversion as the ADC128S052 is able to acquire the input signal to full resolution in the first conversion immediately following power up. The first conversion result after power-up is that of IN0.

## 7.6 Register Maps

**Table 1. Control Register Bits**

7	6	5	4	3	2	1	0
DONTC	DONTC	ADD2	ADD1	ADD0	DONTC	DONTC	DONTC

**Table 2. Control Register Bit Descriptions**

BIT NO.	SYMBOL	DESCRIPTION
7, 6, 2, 1, 0	DONTC	Don't care. The values of these bits do not affect the device.
5	ADD2	These three bits determine which input channel is sampled and converted at the next conversion cycle. The mapping between codes and channels is shown in <a href="#">Table 3</a> .
4	ADD1	
3	ADD0	

**Table 3. Input Channel Selection**

ADD2	ADD1	ADD0	INPUT CHANNEL
0	0	0	IN0 (Default)
0	0	1	IN1
0	1	0	IN2
0	1	1	IN3
1	0	0	IN4
1	0	1	IN5
1	1	0	IN6
1	1	1	IN7

## 8 Application and Implementation

### NOTE

Information in the following applications sections is not part of the TI component specification, and TI does not warrant its accuracy or completeness. TI's customers are responsible for determining suitability of components for their purposes. Customers should validate and test their design implementation to confirm system functionality.

### 8.1 Application Information

#### 8.1.1 Analog Inputs

An equivalent circuit for one of the input channels of the ADC128S052 is shown in Figure 37. Diodes D1 and D2 provide ESD protection for the analog inputs. The operating range for the analog inputs is 0 V to  $V_A$ . Going beyond this range causes the ESD diodes to conduct and result in erratic operation.

The capacitor C1 in Figure 37 has a typical value of 3 pF and is mainly the package pin capacitance. Resistor R1 is the on resistance of the multiplexer and track or hold switch and is typically 500  $\Omega$ . Capacitor C2 is the ADC128S052 sampling capacitor and is typically 30 pF. The ADC128S052 delivers best performance when driven by a low-impedance source (less than 100  $\Omega$ ). This is especially important when using the ADC128S052 to sample dynamic signals. Also important when sampling dynamic signals is a band-pass or low-pass filter which reduces harmonics and noise in the input. These filters are often referred to as anti-aliasing filters.

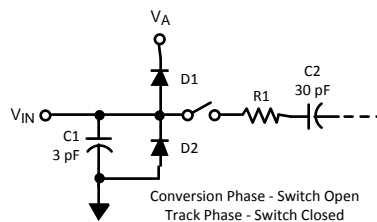

Figure 37. Equivalent Input Circuit

#### 8.1.2 Digital Inputs and Outputs

The digital inputs (SCLK,  $\overline{CS}$ , and DIN) of the ADC128S052 have an operating range of 0 V to  $V_A$ . They are not prone to latch-up and may be asserted before the digital supply ( $V_D$ ) without any risk. The digital output (DOUT) operating range is controlled by  $V_D$ . The output high voltage is  $V_D - 0.5$  V (minimum) while the output low voltage is 0.4 V (maximum).

## 8.2 Typical Application

A typical application is shown in [Figure 38](#). The analog supply is bypassed with a capacitor network located close to the ADC128S052. The ADC128S052 uses the analog supply ( $V_A$ ) as its reference voltage, so it is very important that  $V_A$  be kept as clean as possible. Due to the low power requirements of the ADC128S052, it is also possible to use a precision reference as a power supply.

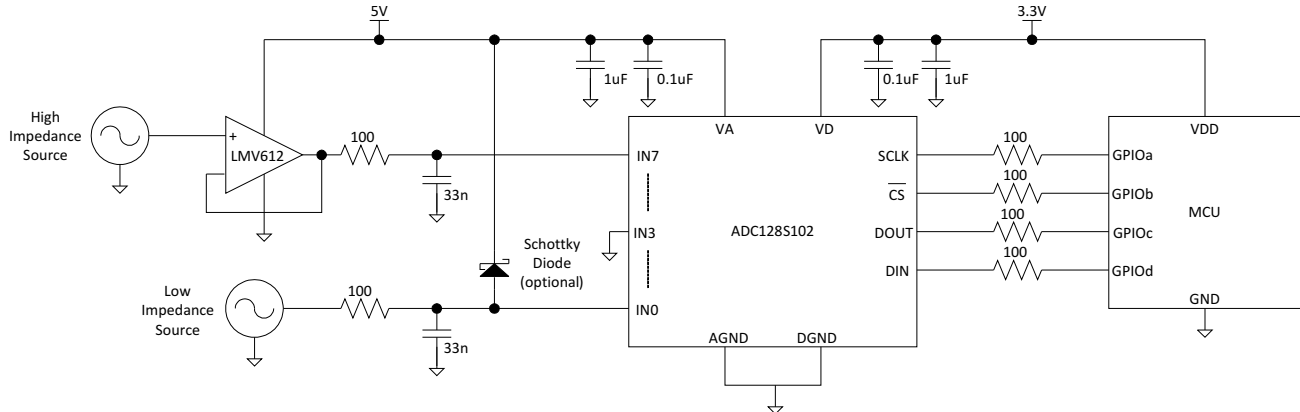

**Figure 38. Typical Application Circuit**

### 8.2.1 Design Requirements

A positive supply-only data acquisition system capable of digitizing signals ranging 0 to 5 V, BW = 10 kHz, and a throughput of 125 kSPS.

The ADC128S052 has to interface to a microcontroller with the supply is set at 3.3 V.

### 8.2.2 Detailed Design Procedure

The signal range requirement forces the design to use 5-V analog supply at  $V_A$ , analog supply. This follows from the fact that  $V_A$  is also a reference potential for the ADC.

The requirement of interfacing to the microcontroller which is powered by a 3.3-V supply, forces the choice of 3.3 V as a  $V_D$  supply.

Sampling is in fact a modulation process which may result in aliasing of the input signal, if the input signal is not adequately band limited. The maximum sampling rate of the ADC128S052 when all channels are enabled is,  $F_s$  is calculated by [Equation 2](#):

$$F_s = \frac{F_{SCLK}}{16 \times 8} \quad (2)$$

Note that faster sampling rates can be achieved when fewer channels are sampled. Single channel can be sampled at the maximum rate of:

$$F_{s\_single} = \frac{F_{SCLK}}{16} \quad (3)$$

In order to avoid the aliasing the Nyquist criterion has to be met:

$$BW_{signal} < \frac{F_s}{2} \quad (4)$$

Therefore it is necessary to place anti-aliasing filters at all inputs of the ADC. These filters may be single-pole low-pass filters. The pole locations need to satisfy, assuming all channels sampled in sequence, [Equation 5](#) and [Equation 6](#):

$$\frac{1}{\pi \times R \times C} < \frac{F_{SCLK}}{16 \times 8} \quad (5)$$

$$R \times C > \frac{128}{\pi \times F_{SCLK}} \quad (6)$$

### Typical Application (continued)

With  $F_{SCLK} = 16$  MHz, a good choice for the single pole filter is:

- $R = 100$
- $C = 33$  nF

This reduces the input  $BW_{signal} = 48$  kHz. The capacitor at the INx input of the device provides not only the filtering of the input signal, but it also absorbs the charge kick-back from the ADC. The kick-back is the result of the internal switches opening at the end of the acquisition period.

The  $V_A$  and  $V_D$  sources are already separated in this example, due to the design requirements. This also benefits the overall performance of the ADC, as the potentially noisy  $V_D$  supply does not contaminate the  $V_A$ . In the same vein, further consideration could be given to the SPI interface, especially when the master microcontroller is capable of producing fast rising edges on the digital bus signals. Inserting small resistances in the digital signal path may help in reducing the ground bounce, and thus improve the overall noise performance of the system.

Take care when the signal source is capable of producing voltages beyond  $V_A$ . In such instances the internal ESD diodes may start conducting. The ESD diodes are not intended as input signal clamps. To provide the desired clamping action use Schottky diodes as shown in [Figure 38](#).

### 8.2.3 Application Curve

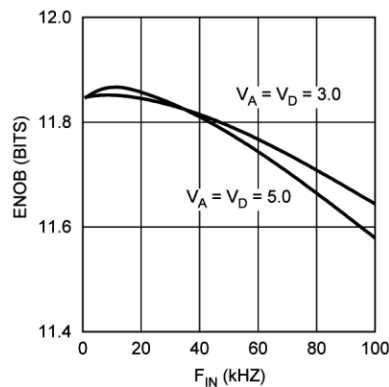

**Figure 39. Typical Performance**

## 9 Power Supply Recommendations

There are three major power supply concerns with this product: power supply sequencing, power management, and the effect of digital supply noise on the analog supply.

### 9.1 Power Supply Sequence

The ADC128S052 is a dual-supply device. The two supply pins share ESD resources, so exercise care to ensure that the power is applied in the correct sequence. To avoid turning on the ESD diodes, the digital supply ( $V_D$ ) cannot exceed the analog supply ( $V_A$ ) by more than 300 mV, not even on a transient basis. Therefore,  $V_A$  must ramp up before or concurrently with  $V_D$ .

### 9.2 Power Supply Noise Considerations

The charging of any output load capacitance requires current from the digital supply,  $V_D$ . The current pulses required from the supply to charge the output capacitance causes voltage variations on the digital supply. If these variations are large enough, they could degrade SNR and SINAD performance of the ADC. Furthermore, if the analog and digital supplies are tied directly together, the noise on the digital supply is coupled directly into the analog supply, causing greater performance degradation than would noise on the digital supply alone. Similarly, discharging the output capacitance when the digital output goes from a logic high to a logic low dumps current into the die substrate, which is resistive. Load discharge currents causes *ground bounce* noise in the substrate that degrades noise performance if that current is large enough. The larger the output capacitance, the more current flows through the die substrate and the greater the noise coupled into the analog channel.

The first solution for keeping digital noise out of the analog supply is to decouple the analog and digital supplies from each other or use separate supplies for them. To keep noise out of the digital supply, keep the output load capacitance as small as practical. If the load capacitance is greater than 50 pF, use a 100- $\Omega$  series resistor at the ADC output, located as close to the ADC output pin as practical. This limits the charge and discharge current of the output capacitance and improves noise performance. Because the series resistor and the load capacitor form a low frequency pole, verify signal integrity once the series resistor has been added.

## 10 Layout

### 10.1 Layout Guidelines

Capacitive coupling between the noisy digital circuitry and the sensitive analog circuitry can lead to poor performance. The solution is to keep the analog circuitry separated from the digital circuitry and the clock line as short as possible.

Digital circuits create substantial supply and ground current transients. The logic noise generated could have significant impact upon system noise performance. To avoid performance degradation of the ADC128S052 due to supply noise, do not use the same supply for the ADC128S052 that is used for digital logic.

Generally, analog and digital lines must cross each other at 90° to avoid crosstalk. However, to maximize accuracy in high resolution systems, avoid crossing analog and digital lines altogether. It is important to keep clock lines as short as possible and isolated from ALL other lines, including other digital lines. In addition, the clock line must also be treated as a transmission line and be properly terminated.

The analog input must be isolated from noisy signal traces to avoid coupling of spurious signals into the input. Any external component (for example, a filter capacitor) connected between the input pins and ground of the converter or to the reference input pin and ground must be connected to a very clean point in the ground plane.

TI recommends the use of a single, uniform ground plane and the use of split power planes. The power planes must be located within the same board layer. All analog circuitry (input amplifiers, filters, reference components, and so forth) must be placed over the analog power plane. All digital circuitry and I/O lines must be placed over the digital power plane. Furthermore, all components in the reference circuitry and the input signal chain that are connected to ground must be connected together with short traces and enter the analog ground plane at a single, quiet point.

### 10.2 Layout Example

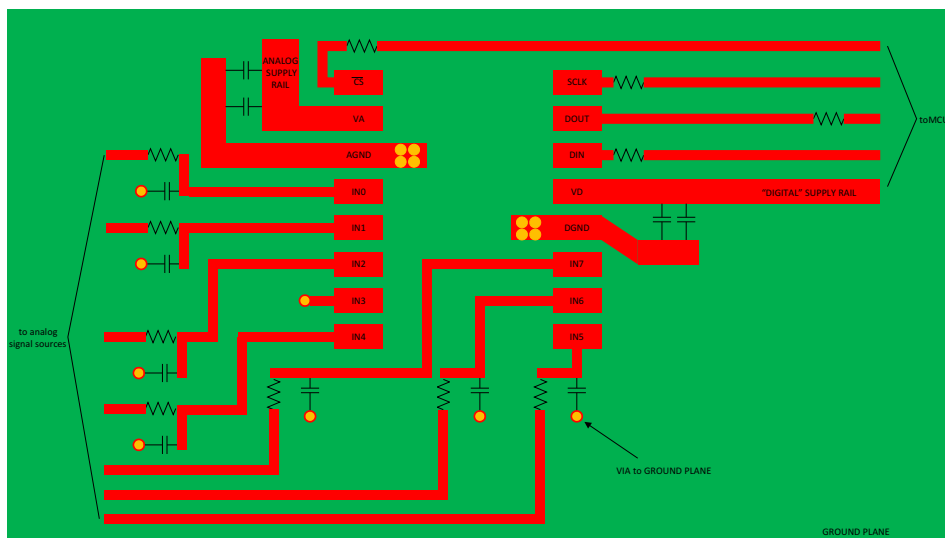

**Figure 40. Layout Schematic**

## 11 Device and Documentation Support

### 11.1 Device Support

#### 11.1.1 Device Nomenclature

##### 11.1.1.1 Specification Definitions

**ACQUISITION TIME** is the time required for the ADC to acquire the input voltage. During this time, the hold capacitor is charged by the input voltage.

**APERTURE DELAY** is the time between the fourth falling edge of SCLK and the time when the input signal is internally acquired or held for conversion.

**CONVERSION TIME** is the time required, after the input voltage is acquired, for the ADC to convert the input voltage to a digital word.

**CHANNEL-TO-CHANNEL ISOLATION** is resistance to coupling of energy from one channel into another channel.

**CROSSTALK** is the coupling of energy from one channel into another channel. This is similar to Channel-to-Channel Isolation, except for the sign of the data.

**DIFFERENTIAL NON-LINEARITY (DNL)** is the measure of the maximum deviation from the ideal step size of 1 LSB.

**DUTY CYCLE** is the ratio of the time that a repetitive digital waveform is high to the total time of one period. The specification here refers to the SCLK.

**EFFECTIVE NUMBER OF BITS (ENOB, or EFFECTIVE BITS)** is another method of specifying Signal-to-Noise and Distortion or SINAD. ENOB is defined as  $(\text{SINAD} - 1.76) / 6.02$  and says that the converter is equivalent to a perfect ADC of this (ENOB) number of bits.

**FULL POWER BANDWIDTH** is a measure of the frequency at which the reconstructed output fundamental drops 3 dB below its low frequency value for a full scale input.

**FULL SCALE ERROR (FSE)** is a measure of how far the last code transition is from the ideal  $1\frac{1}{2}$  LSB below  $V_{\text{REF}}^+$  and is defined as:

$$V_{\text{FSE}} = V_{\text{max}} + 1.5 \text{ LSB} - V_{\text{REF}}^+$$

- where  $V_{\text{max}}$  is the voltage at which the transition to the maximum code occurs. FSE can be expressed in Volts, LSB or percent of full scale range. (7)

**GAIN ERROR** is the deviation of the last code transition (111...110) to (111...111) from the ideal ( $V_{\text{REF}} - 1.5 \text{ LSB}$ ), after adjusting for offset error.

**INTEGRAL NON-LINEARITY (INL)** is a measure of the deviation of each individual code from a line drawn from negative full scale ( $\frac{1}{2}$  LSB below the first code transition) through positive full scale ( $\frac{1}{2}$  LSB above the last code transition). The deviation of any given code from this straight line is measured from the center of that code value.

**INTERMODULATION DISTORTION (IMD)** is the creation of additional spectral components as a result of two sinusoidal frequencies being applied to an individual ADC input at the same time. It is defined as the ratio of the power in both the second or the third order intermodulation products to the power in one of the original frequencies. Second order products are  $f_a \pm f_b$ , where  $f_a$  and  $f_b$  are the two sine wave input frequencies. Third order products are  $(2f_a \pm f_b)$  and  $(f_a \pm 2f_b)$ . IMD is usually expressed in dB.

**MISSING CODES** are those output codes that never appear at the ADC outputs. These codes cannot be reached with any input value. The ADC128S052 is ensured not to have any missing codes.

**OFFSET ERROR** is the deviation of the first code transition (000...000) to (000...001) from the ideal (that is, GND + 0.5 LSB).

**SIGNAL-TO-NOISE RATIO (SNR)** is the ratio, expressed in dB, of the rms value of the input signal to the rms value of the sum of all other spectral components below one-half the sampling frequency, not including d.c. or the harmonics included in THD.



## Device Support (continued)

**SIGNAL-TO-NOISE PLUS DISTORTION (S/N+D or SINAD)** is the ratio, expressed in dB, of the rms value of the input signal to the rms value of all of the other spectral components below half the clock frequency, including harmonics but excluding d.c.

**SPURIOUS FREE DYNAMIC RANGE (SFDR)** is the difference, expressed in dB, between the desired signal amplitude to the amplitude of the peak spurious spectral component, where a spurious spectral component is any signal present in the output spectrum that is not present at the input and may or may not be a harmonic.

**TOTAL HARMONIC DISTORTION (THD)** is the ratio, expressed in dBc, of the rms total of the first five harmonic components at the output to the rms level of the input signal frequency as seen at the output. THD is calculated as

$$\text{THD} = 20 \cdot \log_{10} \sqrt{\frac{A_{f2}^2 + \dots + A_{f10}^2}{A_{f1}^2}}$$

- where  $A_{f1}$  is the RMS power of the input frequency at the output and  $A_{f2}$  through  $A_{f6}$  are the RMS power in the first 5 harmonic frequencies. (8)

**THROUGHPUT TIME** is the minimum time required between the start of two successive conversions. It is the acquisition time plus the conversion and read out times. In the case of the ADC128S052, this is 16 SCLK periods.

## 11.2 Related Links

The table below lists quick access links. Categories include technical documents, support and community resources, tools and software, and quick access to sample or buy.

**Table 4. Related Links**

PARTS	PRODUCT FOLDER	SAMPLE & BUY	TECHNICAL DOCUMENTS	TOOLS & SOFTWARE	SUPPORT & COMMUNITY
ADC128S052	<a href="#">Click here</a>	<a href="#">Click here</a>	<a href="#">Click here</a>	<a href="#">Click here</a>	<a href="#">Click here</a>
ADC128S052-Q1	<a href="#">Click here</a>	<a href="#">Click here</a>	<a href="#">Click here</a>	<a href="#">Click here</a>	<a href="#">Click here</a>

### 11.3 Community Resources

The following links connect to TI community resources. Linked contents are provided "AS IS" by the respective contributors. They do not constitute TI specifications and do not necessarily reflect TI's views; see TI's [Terms of Use](#).

**TI E2E™ Online Community** *TI's Engineer-to-Engineer (E2E) Community*. Created to foster collaboration among engineers. At [e2e.ti.com](http://e2e.ti.com), you can ask questions, share knowledge, explore ideas and help solve problems with fellow engineers.

**Design Support** *TI's Design Support* Quickly find helpful E2E forums along with design support tools and contact information for technical support.

### 11.4 Trademarks

E2E is a trademark of Texas Instruments.

SPI, QSPI are trademarks of Motorola.

All other trademarks are the property of their respective owners.

### 11.5 Electrostatic Discharge Caution



These devices have limited built-in ESD protection. The leads should be shorted together or the device placed in conductive foam during storage or handling to prevent electrostatic damage to the MOS gates.

### 11.6 Glossary





[SLYZ022](#) — *TI Glossary*.

This glossary lists and explains terms, acronyms, and definitions.

## 12 Mechanical, Packaging, and Orderable Information

The following pages include mechanical, packaging, and orderable information. This information is the most current data available for the designated devices. This data is subject to change without notice and revision of this document. For browser-based versions of this data sheet, refer to the left-hand navigation.

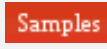
**PACKAGING INFORMATION**

Orderable Device	Status (1)	Package Type	Package Drawing	Pins	Package Qty	Eco Plan (2)	Lead/Ball Finish (6)	MSL Peak Temp (3)	Op Temp (°C)	Device Marking (4/5)	Samples
ADC128S052CIMT/NOPB	ACTIVE	TSSOP	PW	16	92	Green (RoHS & no Sb/Br)	CU SN	Level-1-260C-UNLIM	-40 to 125	128S052 CIMT	
ADC128S052CIMTX	NRND	TSSOP	PW	16		TBD	Call TI	Call TI	-40 to 125		
ADC128S052CIMTX/NOPB	ACTIVE	TSSOP	PW	16	2500	Green (RoHS & no Sb/Br)	CU SN	Level-1-260C-UNLIM	-40 to 125	128S052 CIMT	
ADC128S052QCMT/NOPB	ACTIVE	TSSOP	PW	16	92	Green (RoHS & no Sb/Br)	CU SN	Level-1-260C-UNLIM	-40 to 125	128S052 QCMT	
ADC128S052QCMTX/NOPB	ACTIVE	TSSOP	PW	16	2500	Green (RoHS & no Sb/Br)	CU SN	Level-1-260C-UNLIM	-40 to 125	128S052 QCMT	

(1) The marketing status values are defined as follows:

**ACTIVE:** Product device recommended for new designs.

**LIFEBUY:** TI has announced that the device will be discontinued, and a lifetime-buy period is in effect.

**NRND:** Not recommended for new designs. Device is in production to support existing customers, but TI does not recommend using this part in a new design.

**PREVIEW:** Device has been announced but is not in production. Samples may or may not be available.

**OBSOLETE:** TI has discontinued the production of the device.

(2) Eco Plan - The planned eco-friendly classification: Pb-Free (RoHS), Pb-Free (RoHS Exempt), or Green (RoHS & no Sb/Br) - please check <http://www.ti.com/productcontent> for the latest availability information and additional product content details.

**TBD:** The Pb-Free/Green conversion plan has not been defined.

**Pb-Free (RoHS):** TI's terms "Lead-Free" or "Pb-Free" mean semiconductor products that are compatible with the current RoHS requirements for all 6 substances, including the requirement that lead not exceed 0.1% by weight in homogeneous materials. Where designed to be soldered at high temperatures, TI Pb-Free products are suitable for use in specified lead-free processes.

**Pb-Free (RoHS Exempt):** This component has a RoHS exemption for either 1) lead-based flip-chip solder bumps used between the die and package, or 2) lead-based die adhesive used between the die and leadframe. The component is otherwise considered Pb-Free (RoHS compatible) as defined above.

**Green (RoHS & no Sb/Br):** TI defines "Green" to mean Pb-Free (RoHS compatible), and free of Bromine (Br) and Antimony (Sb) based flame retardants (Br or Sb do not exceed 0.1% by weight in homogeneous material)

(3) MSL, Peak Temp. - The Moisture Sensitivity Level rating according to the JEDEC industry standard classifications, and peak solder temperature.

(4) There may be additional marking, which relates to the logo, the lot trace code information, or the environmental category on the device.

(5) Multiple Device Markings will be inside parentheses. Only one Device Marking contained in parentheses and separated by a "~" will appear on a device. If a line is indented then it is a continuation of the previous line and the two combined represent the entire Device Marking for that device.

(6) Lead/Ball Finish - Orderable Devices may have multiple material finish options. Finish options are separated by a vertical ruled line. Lead/Ball Finish values may wrap to two lines if the finish value exceeds the maximum column width.

**Important Information and Disclaimer:** The information provided on this page represents TI's knowledge and belief as of the date that it is provided. TI bases its knowledge and belief on information provided by third parties, and makes no representation or warranty as to the accuracy of such information. Efforts are underway to better integrate information from third parties. TI has taken and continues to take reasonable steps to provide representative and accurate information but may not have conducted destructive testing or chemical analysis on incoming materials and chemicals. TI and TI suppliers consider certain information to be proprietary, and thus CAS numbers and other limited information may not be available for release.

In no event shall TI's liability arising out of such information exceed the total purchase price of the TI part(s) at issue in this document sold by TI to Customer on an annual basis.

**OTHER QUALIFIED VERSIONS OF ADC128S052, ADC128S052-Q1 :**

- Catalog: [ADC128S052](#)
- Automotive: [ADC128S052-Q1](#)

NOTE: Qualified Version Definitions:

- Catalog - TI's standard catalog product
- Automotive - Q100 devices qualified for high-reliability automotive applications targeting zero defects

## TAPE AND REEL INFORMATION



### QUADRANT ASSIGNMENTS FOR PIN 1 ORIENTATION IN TAPE



\*All dimensions are nominal

Device	Package Type	Package Drawing	Pins	SPQ	Reel Diameter (mm)	Reel Width W1 (mm)	A0 (mm)	B0 (mm)	K0 (mm)	P1 (mm)	W (mm)	Pin1 Quadrant
ADC128S052CIMTX/NOPB	TSSOP	PW	16	2500	330.0	12.4	6.95	5.6	1.6	8.0	12.0	Q1
ADC128S052QCMTX/NO PB	TSSOP	PW	16	2500	330.0	12.4	6.95	5.6	1.6	8.0	12.0	Q1

**TAPE AND REEL BOX DIMENSIONS**

\*All dimensions are nominal

Device	Package Type	Package Drawing	Pins	SPQ	Length (mm)	Width (mm)	Height (mm)
ADC128S052CIMTX/NOP B	TSSOP	PW	16	2500	367.0	367.0	35.0
ADC128S052QCMTX/NOP B	TSSOP	PW	16	2500	367.0	367.0	35.0

PW (R-PDSO-G16)

PLASTIC SMALL OUTLINE

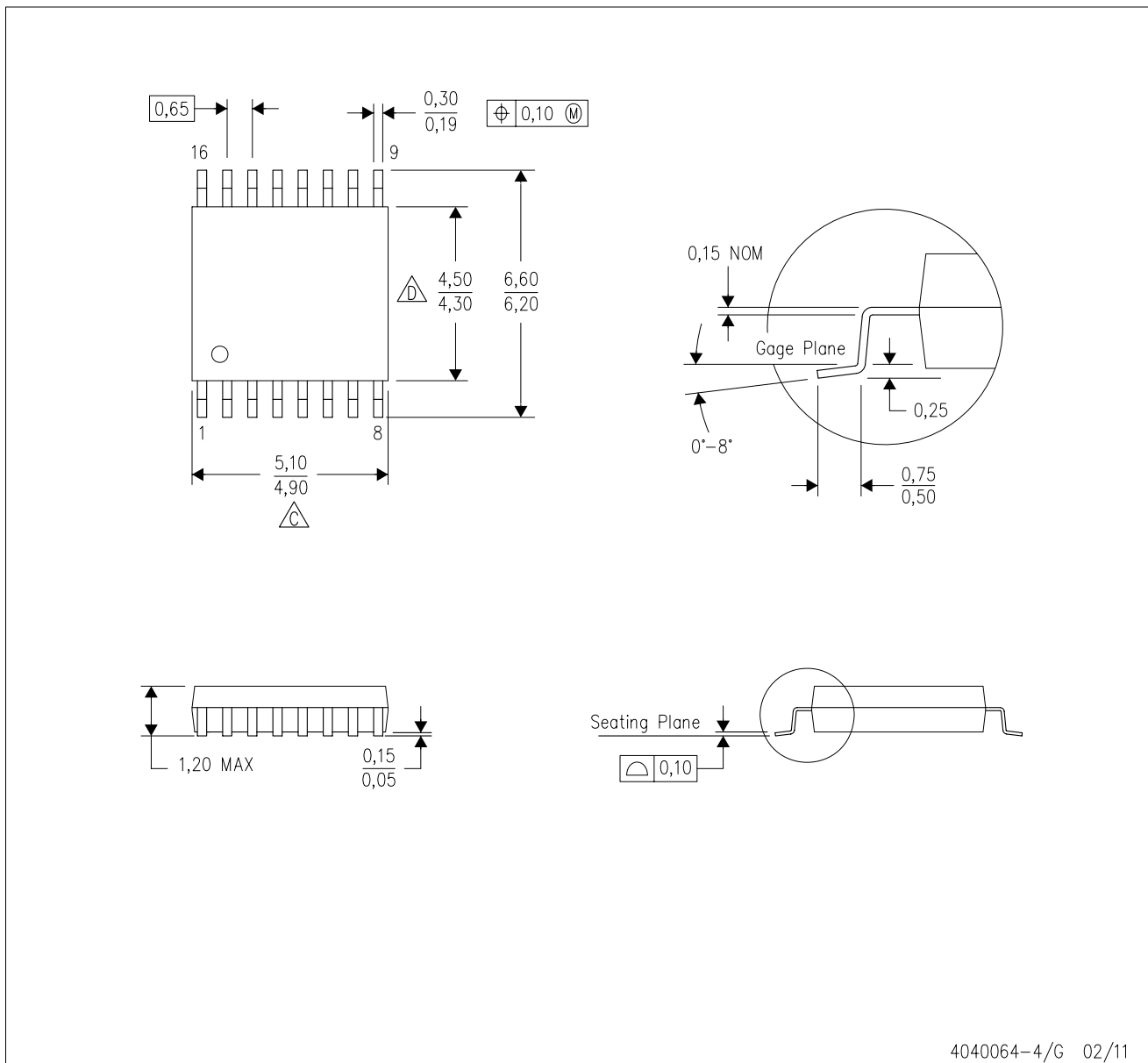

4040064-4/G 02/11

- NOTES:
- A. All linear dimensions are in millimeters. Dimensioning and tolerancing per ASME Y14.5M-1994.
  - B. This drawing is subject to change without notice.
  - C. Body length does not include mold flash, protrusions, or gate burrs. Mold flash, protrusions, or gate burrs shall not exceed 0,15 each side.
  - D. Body width does not include interlead flash. Interlead flash shall not exceed 0,25 each side.
  - E. Falls within JEDEC MO-153

## IMPORTANT NOTICE

Texas Instruments Incorporated and its subsidiaries (TI) reserve the right to make corrections, enhancements, improvements and other changes to its semiconductor products and services per JESD46, latest issue, and to discontinue any product or service per JESD48, latest issue. Buyers should obtain the latest relevant information before placing orders and should verify that such information is current and complete. All semiconductor products (also referred to herein as "components") are sold subject to TI's terms and conditions of sale supplied at the time of order acknowledgment.

TI warrants performance of its components to the specifications applicable at the time of sale, in accordance with the warranty in TI's terms and conditions of sale of semiconductor products. Testing and other quality control techniques are used to the extent TI deems necessary to support this warranty. Except where mandated by applicable law, testing of all parameters of each component is not necessarily performed.

TI assumes no liability for applications assistance or the design of Buyers' products. Buyers are responsible for their products and applications using TI components. To minimize the risks associated with Buyers' products and applications, Buyers should provide adequate design and operating safeguards.

TI does not warrant or represent that any license, either express or implied, is granted under any patent right, copyright, mask work right, or other intellectual property right relating to any combination, machine, or process in which TI components or services are used. Information published by TI regarding third-party products or services does not constitute a license to use such products or services or a warranty or endorsement thereof. Use of such information may require a license from a third party under the patents or other intellectual property of the third party, or a license from TI under the patents or other intellectual property of TI.

Reproduction of significant portions of TI information in TI data books or data sheets is permissible only if reproduction is without alteration and is accompanied by all associated warranties, conditions, limitations, and notices. TI is not responsible or liable for such altered documentation. Information of third parties may be subject to additional restrictions.

Resale of TI components or services with statements different from or beyond the parameters stated by TI for that component or service voids all express and any implied warranties for the associated TI component or service and is an unfair and deceptive business practice. TI is not responsible or liable for any such statements.

Buyer acknowledges and agrees that it is solely responsible for compliance with all legal, regulatory and safety-related requirements concerning its products, and any use of TI components in its applications, notwithstanding any applications-related information or support that may be provided by TI. Buyer represents and agrees that it has all the necessary expertise to create and implement safeguards which anticipate dangerous consequences of failures, monitor failures and their consequences, lessen the likelihood of failures that might cause harm and take appropriate remedial actions. Buyer will fully indemnify TI and its representatives against any damages arising out of the use of any TI components in safety-critical applications.

In some cases, TI components may be promoted specifically to facilitate safety-related applications. With such components, TI's goal is to help enable customers to design and create their own end-product solutions that meet applicable functional safety standards and requirements. Nonetheless, such components are subject to these terms.

No TI components are authorized for use in FDA Class III (or similar life-critical medical equipment) unless authorized officers of the parties have executed a special agreement specifically governing such use.

Only those TI components which TI has specifically designated as military grade or "enhanced plastic" are designed and intended for use in military/aerospace applications or environments. Buyer acknowledges and agrees that any military or aerospace use of TI components which have **not** been so designated is solely at the Buyer's risk, and that Buyer is solely responsible for compliance with all legal and regulatory requirements in connection with such use.

TI has specifically designated certain components as meeting ISO/TS16949 requirements, mainly for automotive use. In any case of use of non-designated products, TI will not be responsible for any failure to meet ISO/TS16949.

### Products

Audio	<a href="http://www.ti.com/audio">www.ti.com/audio</a>
Amplifiers	<a href="http://amplifier.ti.com">amplifier.ti.com</a>
Data Converters	<a href="http://dataconverter.ti.com">dataconverter.ti.com</a>
DLP® Products	<a href="http://www.dlp.com">www.dlp.com</a>
DSP	<a href="http://dsp.ti.com">dsp.ti.com</a>
Clocks and Timers	<a href="http://www.ti.com/clocks">www.ti.com/clocks</a>
Interface	<a href="http://interface.ti.com">interface.ti.com</a>
Logic	<a href="http://logic.ti.com">logic.ti.com</a>
Power Mgmt	<a href="http://power.ti.com">power.ti.com</a>
Microcontrollers	<a href="http://microcontroller.ti.com">microcontroller.ti.com</a>
RFID	<a href="http://www.ti-rfid.com">www.ti-rfid.com</a>
OMAP Applications Processors	<a href="http://www.ti.com/omap">www.ti.com/omap</a>
Wireless Connectivity	<a href="http://www.ti.com/wirelessconnectivity">www.ti.com/wirelessconnectivity</a>

### Applications

Automotive and Transportation	<a href="http://www.ti.com/automotive">www.ti.com/automotive</a>
Communications and Telecom	<a href="http://www.ti.com/communications">www.ti.com/communications</a>
Computers and Peripherals	<a href="http://www.ti.com/computers">www.ti.com/computers</a>
Consumer Electronics	<a href="http://www.ti.com/consumer-apps">www.ti.com/consumer-apps</a>
Energy and Lighting	<a href="http://www.ti.com/energy">www.ti.com/energy</a>
Industrial	<a href="http://www.ti.com/industrial">www.ti.com/industrial</a>
Medical	<a href="http://www.ti.com/medical">www.ti.com/medical</a>
Security	<a href="http://www.ti.com/security">www.ti.com/security</a>
Space, Avionics and Defense	<a href="http://www.ti.com/space-avionics-defense">www.ti.com/space-avionics-defense</a>
Video and Imaging	<a href="http://www.ti.com/video">www.ti.com/video</a>

### TI E2E Community

[e2e.ti.com](http://e2e.ti.com)