

FEATURES

- 16-bit resolution with no missing codes**
- Throughput: 100 kSPS**
- INL: ± 1 LSB typical, ± 3 LSB maximum**
- Pseudo differential analog input range**
- 0 V to V_{REF} with V_{REF} up to VDD**
- Single-supply operation: 2.7 V to 5.5 V**
- Serial interface SPI/QSPI/MICROWIRE/DSP compatible**
- Power dissipation: 4 mW @ 5 V, 1.5 mW @ 2.7 V,
150 μ W @ 2.7 V/10 kSPS**
- Standby current: 1 nA**
- 8-lead packages:**
 - MSOP**
 - 3 mm \times 3 mm QFN (LFCSP) (SOT-23 size)**
- Improved second source to ADS8320 and ADS8325**

APPLICATIONS

- Battery-powered equipment**
- Data acquisition**
- Instrumentation**
- Medical instruments**
- Process control**

GENERAL DESCRIPTION

The **AD7683** is a 16-bit, charge redistribution, successive approximation, PulSAR[®] analog-to-digital converter (ADC) that operates from a single power supply, VDD, between 2.7 V and 5.5 V. It contains a low power, high speed, 16-bit sampling ADC with no missing codes (B grade), an internal conversion clock, and a serial, SPI-compatible interface port. The part also contains a low noise, wide bandwidth, short aperture delay, track-and-hold circuit. On the \overline{CS} falling edge, it samples an

APPLICATION DIAGRAM

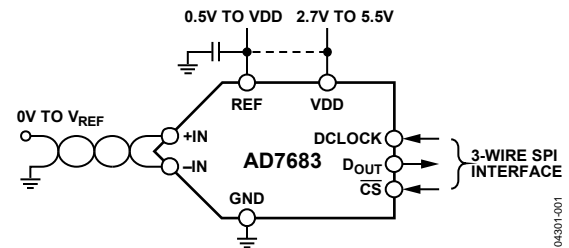

Figure 1.

Table 1. MSOP, QFN (LFCSP)/SOT-23, 14-/16-/18-Bit PulSAR ADC

Type	100 kSPS	250 kSPS	400 kSPS to 500 kSPS	≥ 1000 kSPS	ADC Driver
18-Bit True Differential		AD7691	AD7690	AD7982 AD7984	ADA4941-1 ADA4841-1
16-Bit True Differential	AD7684	AD7687	AD7688 AD7693		ADA4941-1 ADA4841-1
16-Bit Pseudo Differential	AD7680 AD7683	AD7685 AD7694	AD7686	AD7980	ADA4841-1
14-Bit Pseudo Differential	AD7940	AD7942	AD7946		ADA4841-1

analog input, +IN, between 0 V to REF with respect to a ground sense, -IN. The reference voltage, REF, is applied externally and can be set up to the supply voltage. Its power scales linearly with throughput.

The **AD7683** is housed in an 8-lead MSOP or an 8-lead QFN (LFCSP) package, with an operating temperature specified from -40°C to $+85^{\circ}\text{C}$.

AD7683* PRODUCT PAGE QUICK LINKS

Last Content Update: 02/23/2017

COMPARABLE PARTS

View a parametric search of comparable parts.

EVALUATION KITS

- AD7683 Evaluation Kit

DOCUMENTATION

Application Notes

- AN-931: Understanding PuLSAR ADC Support Circuitry
- AN-932: Power Supply Sequencing

Data Sheet

- AD7683: 16-Bit, 100 kSPS, Single-Ended PuLSAR ADC in MSOP/QFN Data Sheet

Product Highlight

- [NO TITLE FOUND] Product Highlight
- 8- to 18-Bit SAR ADCs ... From the Leader in High Performance Analog
- Lowest-Power 16-Bit ADC Optimizes Portable Designs (eeProductCenter, 10/4/2006)

User Guides

- UG-340: Evaluation Board for the 10-Lead Family 14-/16-/18-Bit PuLSAR ADCs
- UG-682: 6-Lead SOT-23 ADC Driver for the 8-/10-Lead Family of 14-/16-/18-Bit PuLSAR ADC Evaluation Boards

SOFTWARE AND SYSTEMS REQUIREMENTS

- BeMicro FPGA Project for AD7683 with Nios driver
- AD7683 FMC-SDP Interposer & Evaluation Board / Xilinx KC705 Reference Design

TOOLS AND SIMULATIONS

- AD7683 IBIS Models

REFERENCE MATERIALS

Technical Articles

- MS-2210: Designing Power Supplies for High Speed ADC

DESIGN RESOURCES

- AD7683 Material Declaration
- PCN-PDN Information
- Quality And Reliability
- Symbols and Footprints

DISCUSSIONS

View all AD7683 EngineerZone Discussions.

SAMPLE AND BUY

Visit the product page to see pricing options.

TECHNICAL SUPPORT

Submit a technical question or find your regional support number.

DOCUMENT FEEDBACK

Submit feedback for this data sheet.

TABLE OF CONTENTS

Features	1	Circuit Information.....	12
Applications.....	1	Converter Operation.....	12
Application Diagram.....	1	Transfer Functions	12
General Description.....	1	Typical Connection Diagram	13
Revision History	2	Analog Input	13
Specifications.....	3	Driver Amplifier Choice	13
Timing Specifications	5	Voltage Reference Input	14
Absolute Maximum Ratings.....	6	Power Supply.....	14
Thermal Resistance	6	Digital Interface.....	14
ESD Caution.....	6	Layout	14
Pin Configurations and Function Descriptions	7	Evaluating the AD7683 Performance	14
Terminology	8	Outline Dimensions	15
Typical Performance Characteristics	9	Ordering Guide	16
Applications Information	12		

REVISION HISTORY

2/16—Rev. A to Rev. B

Changes to Table 1.....	1
Added Figure 7 and Table 9; Renumbered Sequentially	7
Changes to Table 10.....	13
Changes to Digital Interface Section.....	14
Updated Outline Dimensions	16
Changes to Ordering Guide	16

2/08—Rev. 0 to Rev. A

Change to Title.....	1
Moved Figure 3, Figure 4, and Figure 5.....	5
Changes to Figure 4.....	5
Moved Figure 17 and Figure 18	11
Changes to Figure 22.....	13
Updated Outline Dimensions	15
Changes to Ordering Guide	16

9/04—Initial Version: Revision 0

SPECIFICATIONS

VDD = 2.7 V to 5.5 V; V_{REF} = VDD; T_A = -40°C to +85°C, unless otherwise noted.

Table 2.

Parameter	Conditions	AD7683 All Grades			Unit
		Min	Typ	Max	
RESOLUTION		16			Bits
ANALOG INPUT					
Voltage Range	+IN – (–IN)	0		V _{REF}	V
Absolute Input Voltage	+IN	–0.1		VDD + 0.1	V
	–IN	–0.1		0.1	V
Analog Input CMRR	f _{IN} = 100 kHz		65		dB
Leakage Current at 25°C	Acquisition phase		1		nA
Input Impedance		See the Analog Input section			
THROUGHPUT SPEED					
Complete Cycle				10	μs
Throughput Rate		0		100	kSPS
DCLOCK Frequency		0		2.9	MHz
REFERENCE					
Voltage Range		0.5		VDD + 0.3	V
Load Current	100 kSPS, V _{+IN} – V _{–IN} = V _{REF} /2 = 2.5 V		50		μA
DIGITAL INPUTS					
Logic Levels					
V _{IL}		–0.3		0.3 × VDD	V
V _{IH}		0.7 × VDD		VDD + 0.3	V
I _{IL}		–1		+1	μA
I _{IH}		–1		+1	μA
Input Capacitance			5		pF
DIGITAL OUTPUTS					
Data Format		Serial, 16 bits straight binary			
V _{OH}	I _{SOURCE} = –500 μA	VDD – 0.3			V
V _{OL}	I _{SINK} = +500 μA			0.4	V
POWER SUPPLIES					
VDD	Specified performance	2.7		5.5	V
VDD Range ¹		2.0		5.5	V
Operating Current	100 kSPS throughput				
VDD	VDD = 5 V		800		μA
	VDD = 2.7 V		560		μA
Standby Current ^{2,3}	VDD = 5 V, 25°C		1	50	nA
Power Dissipation	VDD = 5 V		4	6	mW
	VDD = 2.7 V		1.5		mW
	VDD = 2.7 V, 10 kSPS throughput ²		150		μW
TEMPERATURE RANGE					
Specified Performance	T _{MIN} to T _{MAX}	–40		+85	°C

¹ See the Typical Performance Characteristics section for more information.

² With all digital inputs forced to VDD or GND, as required.

³ During acquisition phase.

VDD = 5 V; V_{REF} = VDD; T_A = -40°C to +85°C, unless otherwise noted.

Table 3.

Parameter	Conditions	A Grade			B Grade			Unit
		Min	Typ	Max	Min	Typ	Max	
ACCURACY								
No Missing Codes		15			16			Bits
Integral Linearity Error		-6	±3	+6	-3	±1	+3	LSB
Transition Noise			0.5			0.5		LSB
Gain Error ¹ , T _{MIN} to T _{MAX}			±2	±24		±2	±15	LSB
Gain Error Temperature Drift			±0.3			±0.3		ppm/°C
Offset Error ¹ , T _{MIN} to T _{MAX}			±0.7	±1.6		±0.4	±1.6	mV
Offset Temperature Drift			±0.3			±0.3		ppm/°C
Power Supply Sensitivity	VDD = 5 V ± 5%		±0.05			±0.05		LSB
AC ACCURACY								
Signal-to-Noise	f _{IN} = 1 kHz		90		88	91		dB ²
Spurious-Free Dynamic Range	f _{IN} = 1 kHz		-100			-108		dB
Total Harmonic Distortion	f _{IN} = 1 kHz		-100			-106		dB
Signal-to-(Noise + Distortion)	f _{IN} = 1 kHz		90		88	91		dB
Effective Number of Bits	f _{IN} = 1 kHz		14.7			14.8		Bits

¹ See the Terminology section. These specifications include full temperature range variation but do not include the error contribution from the external reference.

² All specifications in dB are referred to a full-scale input, FS. Tested with an input signal at 0.5 dB below full scale, unless otherwise specified.

VDD = 2.7 V; V_{REF} = 2.5V; T_A = -40°C to +85°C, unless otherwise noted.

Table 4.

Parameter	Conditions	A Grade			B Grade			Unit
		Min	Typ	Max	Min	Typ	Max	
ACCURACY								
No Missing Codes		15			16			Bits
Integral Linearity Error		-6	±3	+6	-3	±1	+3	LSB
Transition Noise			0.85			0.85		LSB
Gain Error ¹ , T _{MIN} to T _{MAX}			±2	±30		±2	±15	LSB
Gain Error Temperature Drift			±0.3			±0.3		ppm/°C
Offset Error ¹ , T _{MIN} to T _{MAX}			±0.7	±3.5		±0.7	±3.5	mV
Offset Temperature Drift			±0.3			±0.3		ppm/°C
Power Supply Sensitivity	VDD = 2.7 V ± 5%		±0.05			±0.05		LSB
AC ACCURACY								
Signal-to-Noise	f _{IN} = 1 kHz		85			86		dB ²
Spurious-Free Dynamic Range	f _{IN} = 1 kHz		-96			-100		dB
Total Harmonic Distortion	f _{IN} = 1 kHz		-94			-98		dB
Signal-to-(Noise + Distortion)	f _{IN} = 1 kHz		85			86		dB
Effective Number of Bits	f _{IN} = 1 kHz		13.8			14		Bits

¹ See the Terminology section. These specifications do include full temperature range variation but do not include the error contribution from the external reference.

² All specifications in dB are referred to a full-scale input FS. Tested with an input signal at 0.5 dB below full scale, unless otherwise specified.

TIMING SPECIFICATIONS

VDD = 2.7 V to 5.5 V; TA = -40°C to +85°C, unless otherwise noted.

Table 5.

Parameter	Symbol	Min	Typ	Max	Unit
Throughput Rate	t _{CYC}			100	kHz
CS Falling to DCLOCK Low	t _{CSD}			0	μs
CS Falling to DCLOCK Rising	t _{SUCS}	20			ns
DCLOCK Falling to Data Remains Valid	t _{HDO}	5	16		ns
CS Rising Edge to D _{OUT} High Impedance	t _{DIS}		14	100	ns
DCLOCK Falling to Data Valid	t _{EN}		16	50	ns
Acquisition Time	t _{ACQ}	400			ns
D _{OUT} Fall Time	t _F		11	25	ns
D _{OUT} Rise Time	t _R		11	25	ns

Timing and Circuit Diagrams

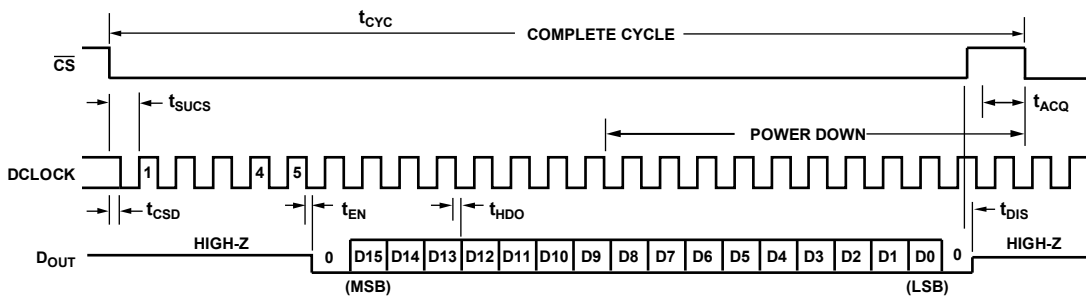

NOTES
 1. A MINIMUM OF 22 CLOCK CYCLES ARE REQUIRED FOR 16-BIT CONVERSION. SHOWN ARE 24 CLOCK CYCLES.
 D_{OUT} GOES LOW ON THE DCLOCK FALLING EDGE FOLLOWING THE LSB READING.

Figure 2. Serial Interface Timing

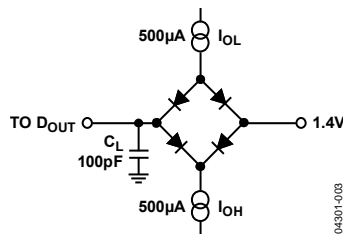

Figure 3. Load Circuit for Digital Interface Timing

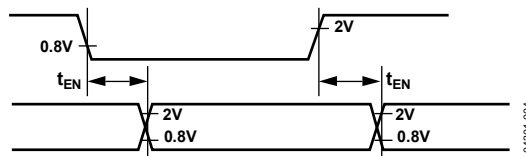

Figure 4. Voltage Reference Levels for Timing

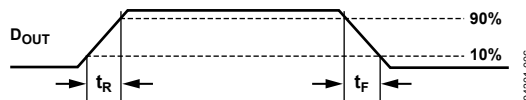

Figure 5. D_{OUT} Rise and Fall Timing

ABSOLUTE MAXIMUM RATINGS

Table 6.

Parameter	Rating
Analog Inputs +IN ¹ , -IN ¹	GND – 0.3 V to VDD + 0.3 V or ±130 mA
REF	GND – 0.3 V to VDD + 0.3 V
Supply Voltages VDD to GND	–0.3 V to +6 V
Digital Inputs to GND	–0.3 V to VDD + 0.3 V
Digital Outputs to GND	–0.3 V to VDD + 0.3 V
Storage Temperature Range	–65°C to +150°C
Junction Temperature	150°C
Lead Temperature Range	JEDEC J-STD-20
Vapor Phase (60 sec)	215°C
Infrared (15 sec)	220°C

¹ See the Analog Input section.

Stresses at or above those listed under Absolute Maximum Ratings may cause permanent damage to the product. This is a stress rating only; functional operation of the product at these or any other conditions above those indicated in the operational section of this specification is not implied. Operation beyond the maximum operating conditions for extended periods may affect product reliability.

THERMAL RESISTANCE

Table 7. Thermal Resistance

Package Type	θ_{JA}	θ_{JC}	Unit
8-Lead MSOP	200	44	°C/W

ESD CAUTION



ESD (electrostatic discharge) sensitive device. Charged devices and circuit boards can discharge without detection. Although this product features patented or proprietary protection circuitry, damage may occur on devices subjected to high energy ESD. Therefore, proper ESD precautions should be taken to avoid performance degradation or loss of functionality.

PIN CONFIGURATIONS AND FUNCTION DESCRIPTIONS

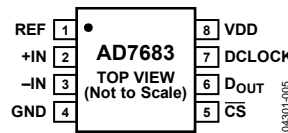
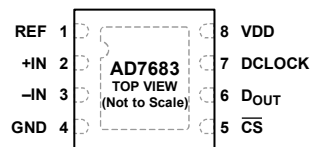

Figure 6. 8-Lead MSOP Pin Configuration

Table 8. 8-Lead MSOP Pin Function Descriptions

Pin No.	Mnemonic	Type ¹	Function
1	REF	AI	Reference Input Voltage. The REF range is from 0.5 V to VDD. It is referred to the GND pin. Decouple the REF pin closely to the GND pin with a ceramic capacitor of a few μF .
2	+IN	AI	Analog Input. It is referred to Pin -IN. The voltage range, that is, the difference between +IN and -IN, is 0 V to V_{REF} .
3	-IN	AI	Analog Input Ground Sense. Connect this pin to either the analog ground plane or a remote sense ground.
4	GND	P	Power Supply Ground.
5	$\overline{\text{CS}}$	DI	Chip Select Input. On its falling edge, it initiates the conversions. The part returns to shutdown mode as soon as the conversion is completed. It also enables D_{OUT} . When high, D_{OUT} is high impedance.
6	D_{OUT}	DO	Serial Data Output. The conversion result is output on this pin. It is synchronized to DCLOCK.
7	DCLOCK	DI	Serial Data Clock Input.
8	VDD	P	Power Supply.

¹ AI = analog input; DI = digital input; DO = digital output; and P = power.



NOTES

- EXPOSED PAD. CONNECT THE EXPOSED PAD TO GND. THIS CONNECTION IS NOT REQUIRED TO MEET SPECIFIED ELECTRICAL PERFORMANCE.

Figure 7. 8-Lead QFN (LFCSP) Pin Configuration

Table 9. 8-Lead QFN (LFCSP) Pin Function Descriptions

Pin No.	Mnemonic	Type ¹	Function
1	REF	AI	Reference Input Voltage. The REF range is from 0.5 V to VDD. It is referred to the GND pin. Decouple the REF pin closely to the GND pin with a ceramic capacitor of a few μF .
2	+IN	AI	Analog Input. It is referred to Pin -IN. The voltage range, that is, the difference between +IN and -IN, is 0 V to V_{REF} .
3	-IN	AI	Analog Input Ground Sense. Connect this pin to either the analog ground plane or a remote sense ground.
4	GND	P	Power Supply Ground.
5	$\overline{\text{CS}}$	DI	Chip Select Input. On its falling edge, it initiates the conversions. The part returns to shutdown mode as soon as the conversion is completed. It also enables D_{OUT} . When high, D_{OUT} is high impedance.
6	D_{OUT}	DO	Serial Data Output. The conversion result is output on this pin. It is synchronized to DCLOCK.
7	DCLOCK	DI	Serial Data Clock Input.
8	VDD EPAD	P	Power Supply. Exposed Pad. Connect the exposed pad to GND. This connection is not required to meet specified electrical performance.

¹ AI = analog input; DI = digital input; DO = digital output; and P = power.

TERMINOLOGY

Integral Nonlinearity Error (INL)

Linearity error refers to the deviation of each individual code from a line drawn from negative full scale through positive full scale. The point used as negative full scale occurs $\frac{1}{2}$ LSB before the first code transition. Positive full scale is defined as a level $1\frac{1}{2}$ LSB beyond the last code transition. The deviation is measured from the middle of each code to the true straight line (see Figure 22).

Differential Nonlinearity Error (DNL)

In an ideal ADC, code transitions are 1 LSB apart. DNL is the maximum deviation from this ideal value. It is often specified in terms of resolution for which no missing codes are guaranteed.

Offset Error

The first transition should occur at a level $\frac{1}{2}$ LSB above analog ground (38.1 μ V for the 0 V to 5 V range). The offset error is the deviation of the actual transition from that point.

Gain Error

The last transition (from 111...10 to 111...11) should occur for an analog voltage $1\frac{1}{2}$ LSB below the nominal full scale (4.999886 V for the 0 V to 5 V range). The gain error is the deviation of the actual level of the last transition from the ideal level after the offset has been adjusted out.

Spurious-Free Dynamic Range (SFDR)

The difference, in decibels (dB), between the rms amplitude of the input signal and the peak spurious signal.

Signal-to-(Noise + Distortion) Ratio (SINAD)

SINAD is the ratio of the rms value of the actual input signal to the rms sum of all other spectral components below the Nyquist frequency, including harmonics but excluding dc. The value for SINAD is expressed in dB.

Effective Number of Bits (ENOB)

ENOB is a measurement of the resolution with a sine wave input. It is related to SINAD (as represented by $S/(N+D)$) by the following formula and is expressed in bits:

$$ENOB = (S/[N + D]_{dB} - 1.76) / 6.02$$

Total Harmonic Distortion (THD)

THD is the ratio of the rms sum of the first five harmonic components to the rms value of a full-scale input signal and is expressed in dB.

Signal-to-Noise Ratio (SNR)

SNR is the ratio of the rms value of the actual input signal to the rms sum of all other spectral components below the Nyquist frequency, excluding harmonics and dc. The value for SNR is expressed in dB.

Aperture Delay

Aperture delay is a measure of the acquisition performance and is the time between the falling edge of the \overline{CS} input and when the input signal is held for a conversion.

Transient Response

Transient response is the time required for the ADC to accurately acquire its input after a full-scale step function is applied.

TYPICAL PERFORMANCE CHARACTERISTICS

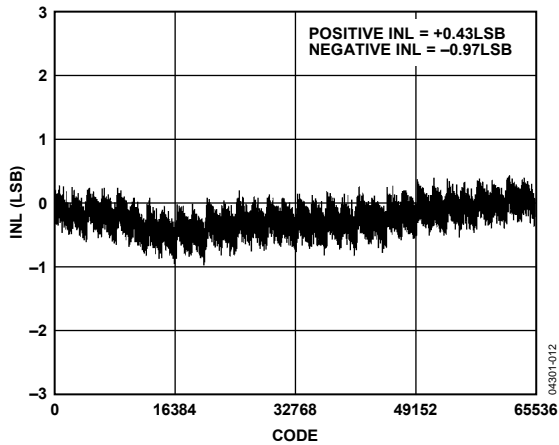

Figure 8. Integral Nonlinearity vs. Code

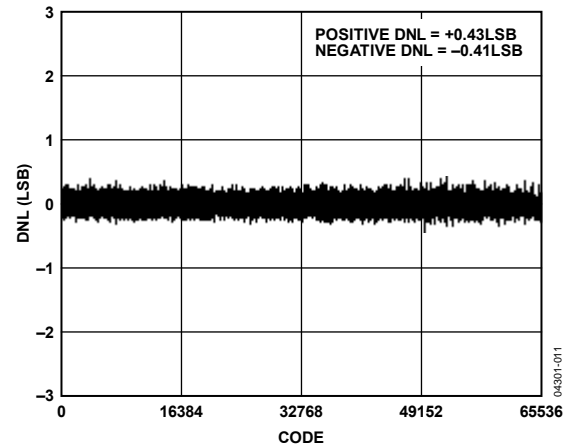

Figure 11. Differential Nonlinearity vs. Code

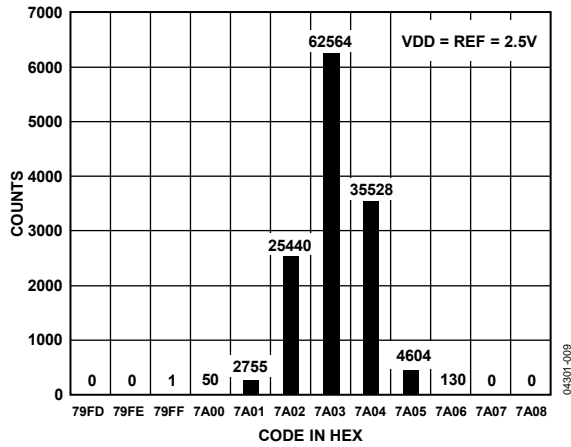

Figure 9. Histogram of a DC Input at the Code Center

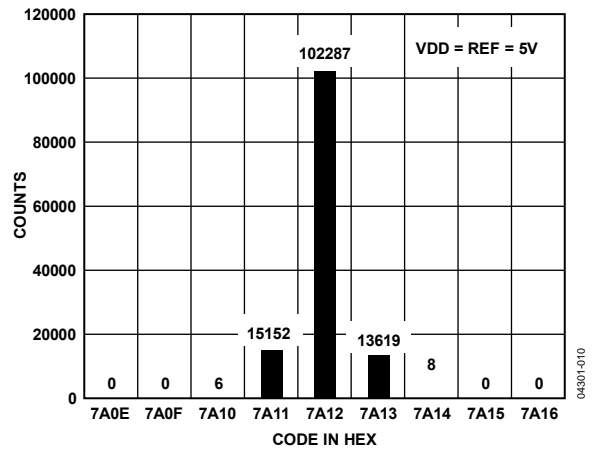

Figure 12. Histogram of a DC Input at the Code Center

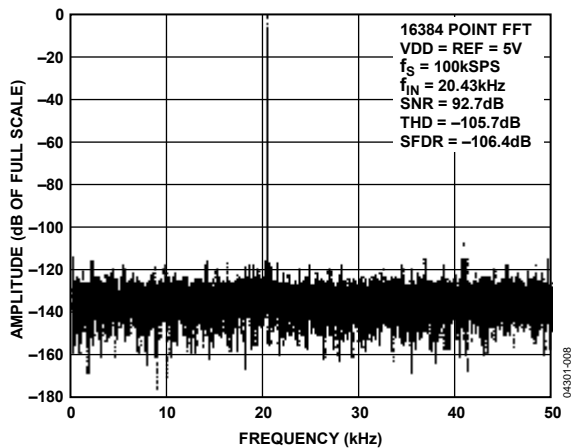

Figure 10. FFT Plot

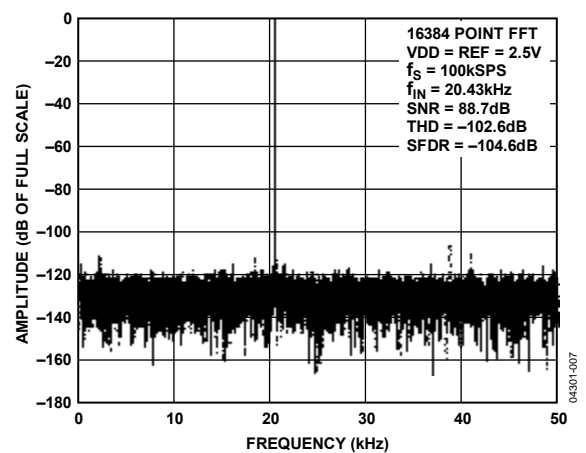

Figure 13. FFT Plot

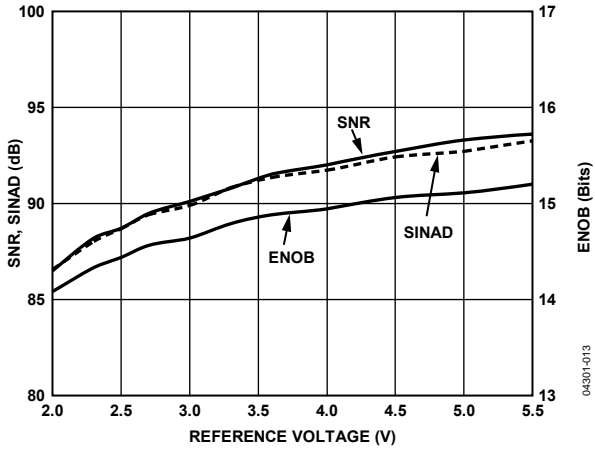

Figure 14. SNR, SINAD, and ENOB vs. Reference Voltage

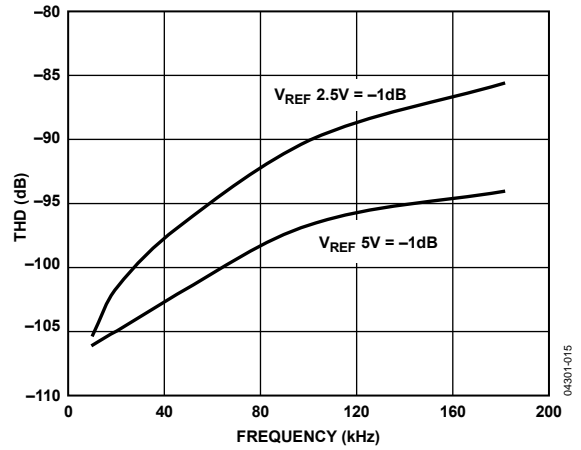

Figure 16. THD vs. Frequency

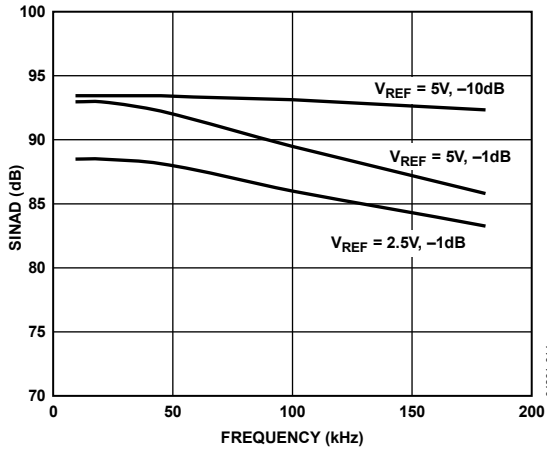

Figure 15. SINAD vs. Frequency

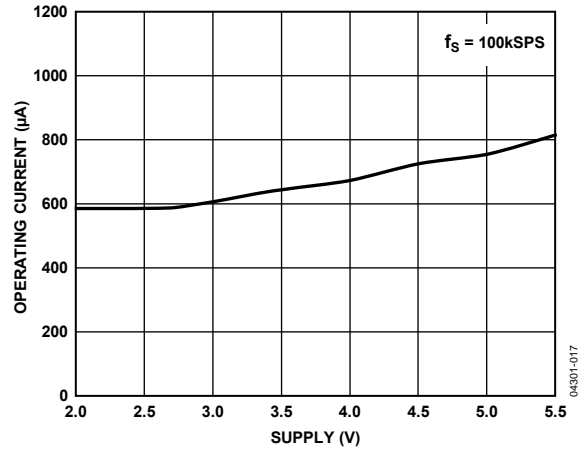

Figure 17. Operating Current vs. Supply

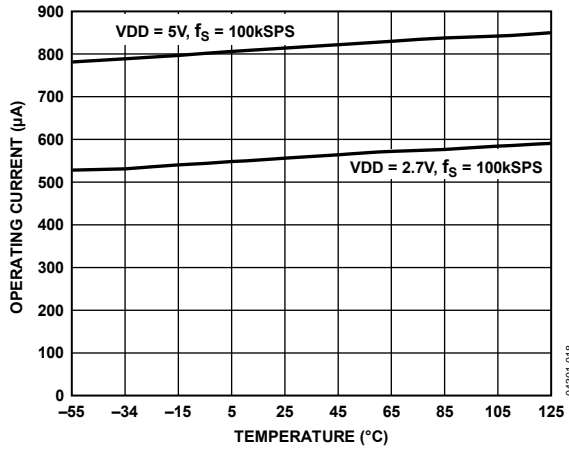

Figure 18. Operating Current vs. Temperature

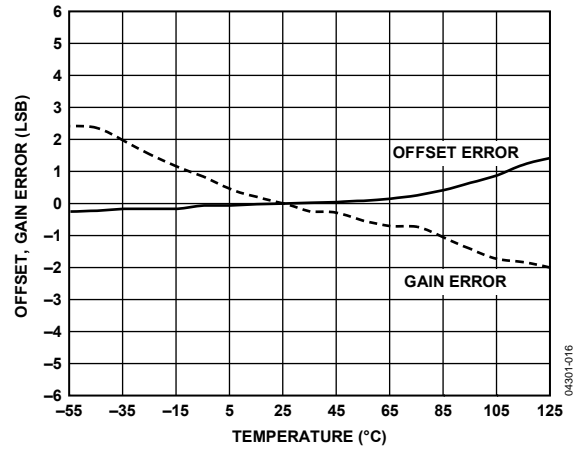

Figure 20. Offset and Gain Error vs. Temperature

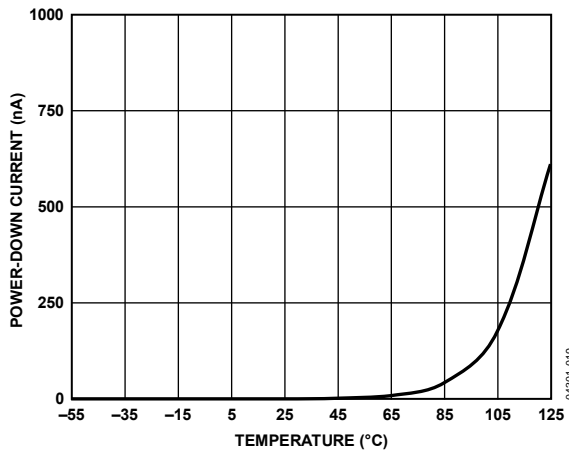

Figure 19. Power-Down Current vs. Temperature

APPLICATIONS INFORMATION

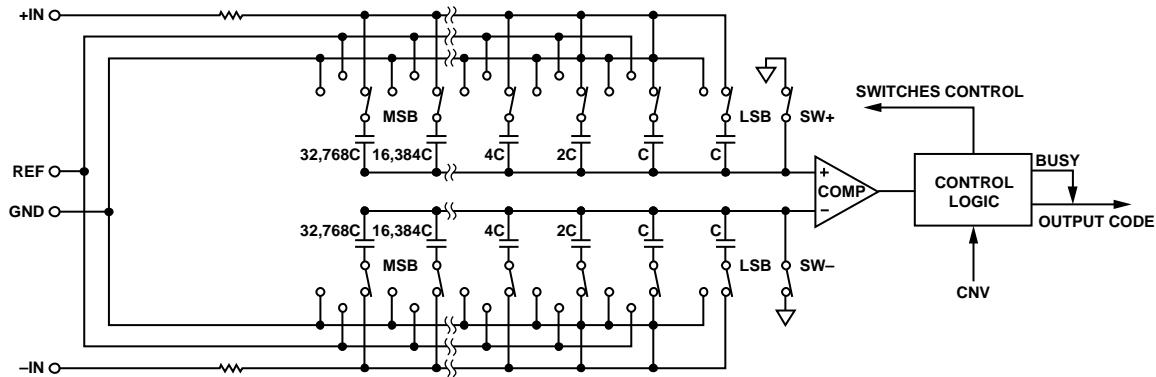

Figure 21. ADC Simplified Schematic

CIRCUIT INFORMATION

The AD7683 is a low power, single-supply, 16-bit ADC using a successive approximation architecture.

The AD7683 is capable of converting 100,000 samples per second (100 kSPS) and powers down between conversions. When operating at 10 kSPS, for example, it consumes typically 150 μ W with a 2.7 V supply, ideal for battery-powered applications.

The AD7683 provides the user with an on-chip track-and-hold and does not exhibit any pipeline delay or latency, making it ideal for multiple, multiplexed channel applications.

The AD7683 is specified from 2.7 V to 5.5 V. It is housed in an 8-lead MSOP or a tiny, 8-lead QFN (LFCSP) package.

The AD7683 is an improved second source to the ADS8320 and ADS8325. For even better performance, consider the AD7685.

CONVERTER OPERATION

The AD7683 is a successive approximation ADC based on a charge redistribution DAC. Figure 21 shows the simplified schematic of the ADC. The capacitive DAC consists of two identical arrays of 16 binary-weighted capacitors that connect to the two comparator inputs.

During the acquisition phase, terminals of the array tied to the comparator's input are connected to GND via SW+ and SW-. All independent switches are connected to the analog inputs. Thus, the capacitor arrays are used as sampling capacitors and acquire the analog signal on the +IN and -IN inputs. When the acquisition phase is complete and the \overline{CS} input goes low, a conversion phase is initiated. When the conversion phase begins, SW+ and SW- are opened first. The two capacitor arrays are then disconnected from the inputs and connected to the GND input. Therefore, the differential voltage between the inputs, +IN and -IN, captured at the end of the acquisition phase is applied to the comparator inputs, causing the comparator to become unbalanced. By switching each element of the capacitor

array between GND and REF, the comparator input varies by binary-weighted voltage steps ($V_{REF}/2$, $V_{REF}/4 \dots V_{REF}/65,536$). The control logic toggles these switches, starting with the MSB, to bring the comparator back into a balanced condition. After the completion of this process, the part returns to the acquisition phase and the control logic generates the ADC output code.

TRANSFER FUNCTIONS

The ideal transfer function for the AD7683 is shown in Figure 22 and Table 10.

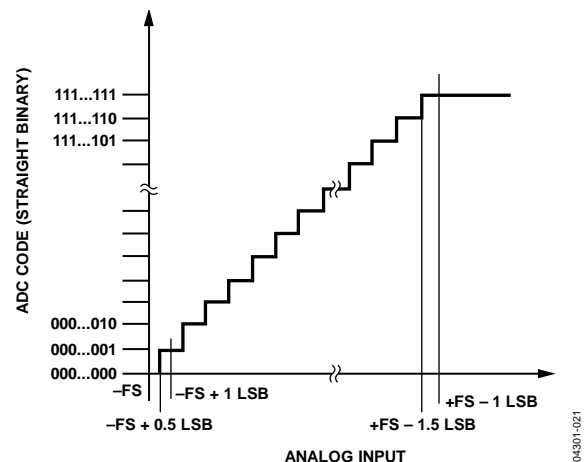

Figure 22. ADC Ideal Transfer Function

Table 10. Output Codes and Ideal Input Voltages

Description	Analog Input $V_{REF} = 5 \text{ V}$	Digital Output Code Hexadecimal
FSR - 1 LSB	4.999924 V	FFFF ¹
Midscale + 1 LSB	2.500076 V	8001
Midscale	2.5 V	8000
Midscale - 1 LSB	2.499924 V	7FFF
-FSR + 1 LSB	76.3 μ V	0001
-FSR	0 V	0000 ²

¹ This is also the code for an overranged analog input ($V_{+IN} - V_{-IN}$ above $V_{REF} - V_{GND}$).

² This is also the code for an underranged analog input ($V_{+IN} - V_{-IN}$ below V_{GND}).

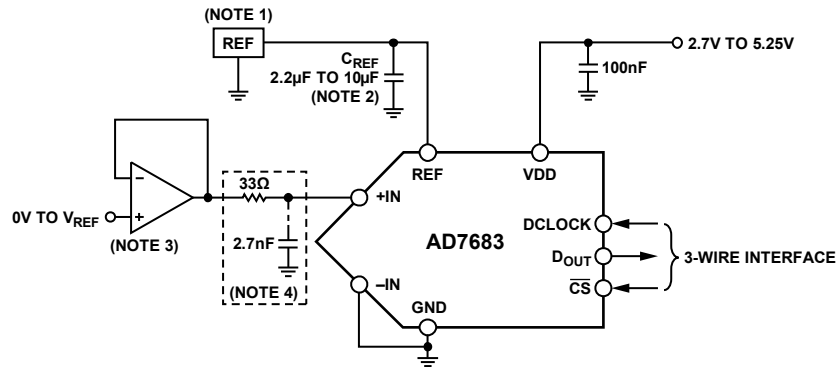

NOTES

1. SEE VOLTAGE REFERENCE INPUT SECTION FOR REFERENCE SELECTION.
2. C_{REF} IS USUALLY A $10\mu\text{F}$ CERAMIC CAPACITOR (X5R).
3. SEE DRIVER AMPLIFIER CHOICE SECTION.
4. OPTIONAL FILTER. SEE ANALOG INPUT SECTION.

Figure 23. Typical Application Diagram

TYPICAL CONNECTION DIAGRAM

Figure 23 shows an example of the recommended application diagram for the AD7683.

ANALOG INPUT

Figure 24 shows an equivalent circuit of the input structure of the AD7683. The two diodes, D1 and D2, provide ESD protection for the analog inputs, +IN and -IN. Care must be taken to ensure that the analog input signal never exceeds the supply rails by more than 0.3 V because this causes these diodes to become forward-biased and start conducting current. However, these diodes can handle a forward-biased current of 130 mA maximum. For instance, these conditions can eventually occur when the input buffer (U1) supplies are different from VDD. In such a case, use an input buffer with a short-circuit current limitation to protect the part.

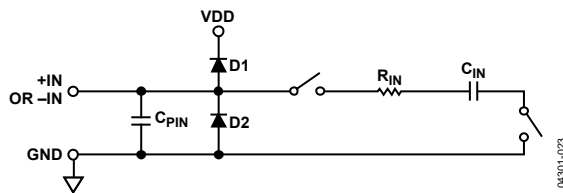

Figure 24. Equivalent Analog Input Circuit

This analog input structure allows the sampling of the differential signal between +IN and -IN. By using this differential input, small signals common to both inputs are rejected. For instance, by using -IN to sense a remote signal ground, ground potential differences between the sensor and the local ADC ground are eliminated. During the acquisition phase, the impedance of the analog input, +IN, can be modeled as a parallel combination of Capacitor C_{PIN} and the network formed by the series connection of R_{IN} and C_{IN} . C_{PIN} is primarily the pin capacitance. R_{IN} is typically $600\ \Omega$ and is a lumped component consisting of some serial resistors and the on resistance of the switches. C_{IN} is typically $30\ \text{pF}$ and is mainly the ADC sampling capacitor. During the conversion phase, when the switches are opened, the input impedance is limited to C_{PIN} . R_{IN} and C_{IN} make a 1-pole, low-

pass filter that reduces undesirable aliasing effects and limits the noise.

When the source impedance of the driving circuit is low, the AD7683 can be driven directly. Large source impedances significantly affect the ac performance, especially THD. The dc performances are less sensitive to the input impedance.

DRIVER AMPLIFIER CHOICE

Although the AD7683 is easy to drive, the driver amplifier needs to meet the following requirements:

- The noise generated by the driver amplifier needs to be kept as low as possible to preserve the SNR and transition noise performance of the AD7683. Note that the AD7683 has a noise figure much lower than most other 16-bit ADCs and, therefore, can be driven by a noisier op amp while preserving the same or better system performance. The noise coming from the driver is filtered by the AD7683 analog input circuit, 1-pole, low-pass filter made by R_{IN} and C_{IN} or by the external filter, if one is used.
- For ac applications, the driver needs to have a THD performance suitable to that of the AD7683. Figure 16 shows the THD vs. frequency that the driver should exceed.
- For multichannel multiplexed applications, the driver amplifier and the AD7683 analog input circuit must be able to settle for a full-scale step of the capacitor array at a 16-bit level (0.0015%). In the amplifier data sheet, settling at 0.1% to 0.01% is more commonly specified. This could differ significantly from the settling time at a 16-bit level and should be verified prior to driver selection.

Table 11. Recommended Driver Amplifiers

Amplifier	Typical Application
ADA4841-1	Very low noise and low power
OP184	Low power, low noise, and low frequency
AD8605, AD8615	5 V single-supply, low power
AD8519	Low power and low frequency
AD8031	High frequency and low power

VOLTAGE REFERENCE INPUT

The AD7683 voltage reference input, REF, has a dynamic input impedance. Therefore, it should be driven by a low impedance source with efficient decoupling between the REF and GND pins, as explained in the Layout section.

When REF is driven by a very low impedance source (such as an unbuffered reference voltage like the low temperature drift ADR435 reference or a reference buffer using the AD8031 or the AD8605), a 10 μF (X5R, 0805 size) ceramic chip capacitor is appropriate for optimum performance.

If desired, smaller reference decoupling capacitors with values as low as 2.2 μF can be used with a minimal impact on performance, especially DNL.

POWER SUPPLY

The AD7683 powers down automatically at the end of each conversion phase and, therefore, the power scales linearly with the sampling rate, as shown in Figure 25. This makes the part ideal for low sampling rates (even of a few Hz) and low battery-powered applications.

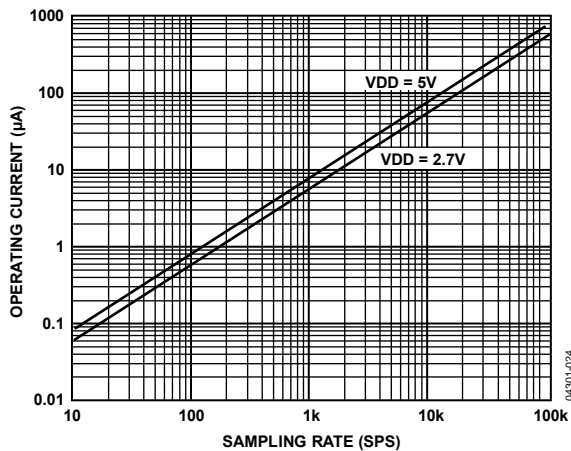

Figure 25. Operating Current vs. Sampling Rate

DIGITAL INTERFACE

The AD7683 is compatible with SPI[®], QSPI[™], digital hosts, MICROWIRE[™], and DSPs (for example, Blackfin[®] ADSP-BF531, ADSP-BF532, ADSP-BF533, or the ADSP-2191M). The connection diagram is shown in Figure 26 and the corresponding timing is given in Figure 2.

A falling edge on $\overline{\text{CS}}$ initiates a conversion and the data transfer. After the fifth DCLOCK falling edge, D_{OUT} is enabled and forced low. The data bits are then clocked, MSB first, by subsequent

DCLOCK falling edges. The data is valid on both DCLOCK edges. Although the rising edge can be used to capture the data, a digital host also using the DCLOCK falling edge allows a faster reading rate, provided it has an acceptable hold time.

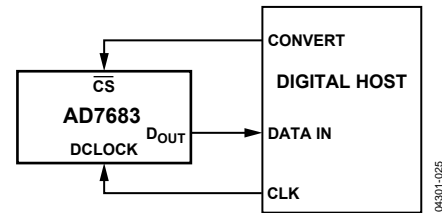

Figure 26. Connection Diagram

LAYOUT

Design the PCB that houses the AD7683 so that the analog and digital sections are separated and confined to certain areas of the board. The pin configuration of the AD7683, with all its analog signals on the left side and all its digital signals on the right side, eases this task.

Avoid running digital lines under the device because these couple noise onto the die, unless a ground plane under the AD7683 is used as a shield. Fast switching signals, such as $\overline{\text{CS}}$ or clocks, should never run near analog signal paths. Avoid crossover of digital and analog signals.

Use at least one ground plane. It can be common or split between the digital and analog sections. In such a case, it should be joined underneath the AD7683.

The AD7683 voltage reference input (REF) has a dynamic input impedance and should be decoupled with minimal parasitic inductances. Accomplish this by placing the reference decoupling ceramic capacitor close to, and ideally right up against, the REF and GND pins and by connecting these pins with wide, low impedance traces.

Finally, decouple the power supply, VDD, of the AD7683 with a ceramic capacitor, typically 100 nF, placed close to the AD7683. Connect it using short and large traces to provide low impedance paths and reduce the effect of glitches on the power supply lines.

EVALUATING THE AD7683 PERFORMANCE

Other recommended layouts for the AD7683 are outlined in the evaluation board for the AD7683 (EVAL-AD7683CBZ). The evaluation board package includes a fully assembled and tested evaluation board, documentation, and software for controlling the board from a PC via the EVAL-CONTROL BRD3Z.

OUTLINE DIMENSIONS

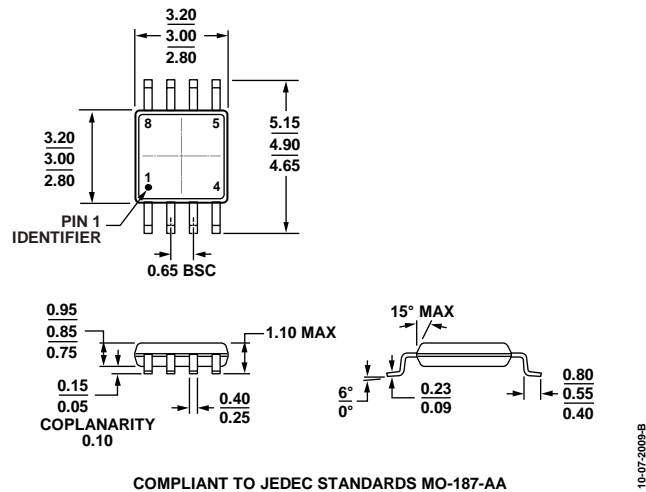

COMPLIANT TO JEDEC STANDARDS MO-187-AA

Figure 27. 8-Lead Mini Small Outline Package [MSOP] (RM-8)

Dimensions Shown in millimeters

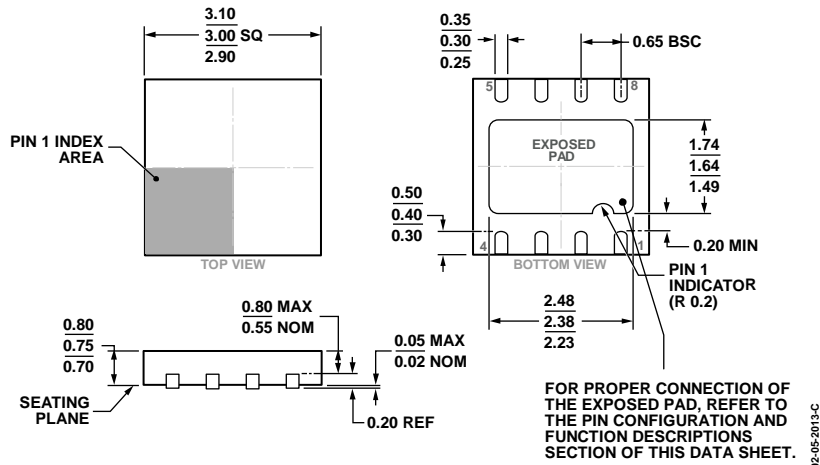

Figure 28. 8-Terminal Quad Flat No Lead Package (QFN) [LFCSP_WD] 3 mm x 3 mm Body, Very Very Thin, Dual Lead (CP-8-3)

Dimensions Shown in millimeters

ORDERING GUIDE

Model ¹	Integral Nonlinearity	Temperature Range	Package Description ²	Package Option	Branding	Ordering Quantity
AD7683ACPZRL7	±6 LSB max	–40°C to +85°C	8-Lead QFN [LFCSP_WD]	CP-8-3	C4G	Reel, 1,500
AD7683ARMZ	±6 LSB max	–40°C to +85°C	8-Lead MSOP	RM-8	C4G	Tube, 50
AD7683ARMZRL7	±6 LSB max	–40°C to +85°C	8-Lead MSOP	RM-8	C4G	Reel, 1,000
AD7683BCPZRL7	±3 LSB max	–40°C to +85°C	8-Lead QFN [LFCSP_WD]	CP-8-3	C38	Reel, 1,500
AD7683BRMZ	±3 LSB max	–40°C to +85°C	8-Lead MSOP	RM-8	C38	Tube, 50
AD7683BRMZRL7	±3 LSB max	–40°C to +85°C	8-Lead MSOP	RM-8	C38	Reel, 1,000
EVAL-AD7683SDZ			Evaluation Board			
EVAL-CONTROL BRD3Z			Controller Board			

¹ Z = RoHS Compliant Part.

² The EVAL CONTROL BRD3Z board allows a PC to control and communicate with all Analog Devices evaluation boards ending in the CB designators.