

# 74LVC1G384

## Bilateral switch

Rev. 9 — 16 August 2022

Product data sheet

## 1. General description

The 74LVC1G384 is a single pole, single throw analog switch. It has two input/output terminals (Y and Z) and an enable pin (E). When  $\bar{E}$  is HIGH, the analog switch is turned off. Control inputs can be driven from either 3.3 V or 5 V devices. This feature allows the use of these devices as translators in mixed 3.3 V and 5 V environments.

Schmitt-trigger action at control inputs makes the circuit tolerant of slower input rise and fall times.

## 2. Features and benefits

- Wide supply voltage range from 1.65 V to 5.5 V
- Very low ON resistance:
  - 7.5  $\Omega$  (typical) at  $V_{CC} = 2.7$  V
  - 6.5  $\Omega$  (typical) at  $V_{CC} = 3.3$  V
  - 6  $\Omega$  (typical) at  $V_{CC} = 5$  V
- ESD protection:
  - HBM EIA/JESD22-A114-A exceeds 2000 V
  - MM EIA/JESD22-A115-A exceeds 200 V
- 32 mA continuous switch current
- High noise immunity
- CMOS low power dissipation
- TTL interface compatibility at 3.3 V
- Latch-up performance meets requirements of JESD 78 Class I
- Overvoltage tolerant inputs to 5.5 V
- Multiple package options
- Specified from -40 °C to +85 °C and from -40 °C to +125 °C

## 3. Ordering information

Table 1. Ordering information

Type number	Package			
	Temperature range	Name	Description	Version
<a href="#">74LVC1G384GW</a>	-40 °C to +125 °C	TSSOP5	plastic thin shrink small outline package; 5 leads; body width 1.25 mm	<a href="#">SOT353-1</a>
<a href="#">74LVC1G384GV</a>	-40 °C to +125 °C	SC-74A	plastic surface-mounted package; 5 leads	<a href="#">SOT753</a>
<a href="#">74LVC1G384GM</a>	-40 °C to +125 °C	XSON6	plastic extremely thin small outline package; no leads; 6 terminals; body 1 × 1.45 × 0.5 mm	<a href="#">SOT886</a>
<a href="#">74LVC1G384GN</a>	-40 °C to +125 °C	XSON6	extremely thin small outline package; no leads; 6 terminals; body 0.9 × 1.0 × 0.35 mm	<a href="#">SOT1115</a>
<a href="#">74LVC1G384GS</a>	-40 °C to +125 °C	XSON6	extremely thin small outline package; no leads; 6 terminals; body 1.0 × 1.0 × 0.35 mm	<a href="#">SOT1202</a>
<a href="#">74LVC1G384GX</a>	-40 °C to +125 °C	X2SON5	plastic thermal enhanced extremely thin small outline package; no leads; 5 terminals; body 0.8 × 0.8 × 0.32 mm	<a href="#">SOT1226-3</a>

## 4. Marking

Table 2. Marking

Type number	Marking code[1]
74LVC1G384GW	YL
74LVC1G384GV	YL
74LVC1G384GM	YL
74LVC1G384GN	YL
74LVC1G384GS	YL
74LVC1G384GX	YL

[1] The pin 1 indicator is located on the lower left corner of the device, below the marking code.

## 5. Functional diagram

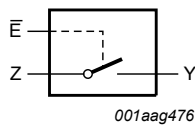

Fig. 1. Logic symbol

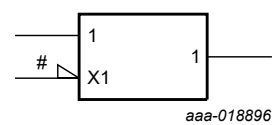

Fig. 2. IEC logic symbol

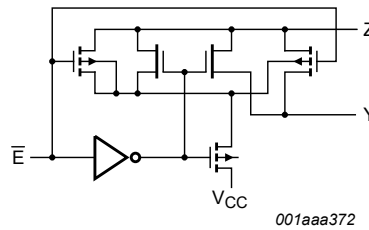

Fig. 3. Logic diagram

## 6. Pinning information

### 6.1. Pinning

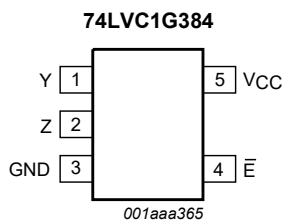

Fig. 4. Pin configuration SOT353-1 (TSSOP5) and SOT753 (SC-74A)

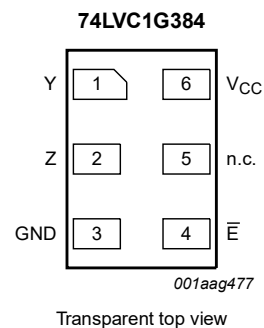
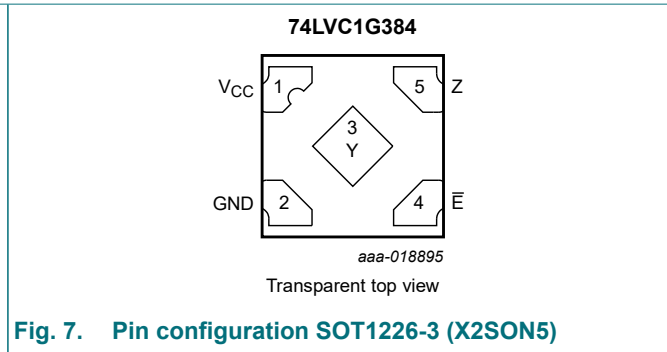
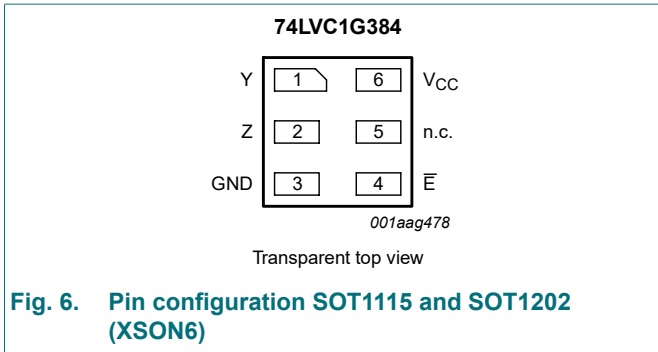

Fig. 5. Pin configuration SOT886 (XSON6)



## 6.2. Pin description

Table 3. Pin description

Symbol	Pin			Description
	TSSOP5 and SC-74	XSON6	X2SON5	
Y	1	1	3	independent input or output
Z	2	2	5	independent output or input
GND	3	3	2	ground (0 V)
$\bar{E}$	4	4	4	enable input (active LOW)
n.c.	-	5	-	not connected
V <sub>CC</sub>	5	6	1	supply voltage

## 7. Functional description

Table 4. Function table

H = HIGH voltage level; L = LOW voltage level.

Input $\bar{E}$	Switch
L	ON-state
H	OFF-state

## 8. Limiting values

**Table 5. Limiting values**

In accordance with the Absolute Maximum Rating System (IEC 60134). Voltages are referenced to GND (ground = 0 V).

Symbol	Parameter	Conditions	Min	Max	Unit
$V_{CC}$	supply voltage		-0.5	+6.5	V
$V_I$	input voltage	[1]	-0.5	+6.5	V
$I_{IK}$	input clamping current	$V_I < -0.5\text{ V}$ or $V_I > V_{CC} + 0.5\text{ V}$	-50	-	mA
$I_{SK}$	switch clamping current	$V_I < -0.5\text{ V}$ or $V_I > V_{CC} + 0.5\text{ V}$	-	$\pm 50$	mA
$V_{SW}$	switch voltage	enable and disable mode [2]	-0.5	$V_{CC} + 0.5$	V
$I_{SW}$	switch current	$V_{SW} > -0.5\text{ V}$ or $V_{SW} < V_{CC} + 0.5\text{ V}$	-	$\pm 50$	mA
$I_{CC}$	supply current		-	100	mA
$I_{GND}$	ground current		-100	-	mA
$T_{stg}$	storage temperature		-65	+150	°C
$P_{tot}$	total power dissipation	$T_{amb} = -40\text{ °C}$ to $+125\text{ °C}$ [3]	-	250	mW

[1] The minimum input voltage rating may be exceeded if the input current rating is observed.

[2] The minimum and maximum switch voltage ratings may be exceeded if the switch clamping current rating is observed.

[3] For SOT353-1 (TSSOP5) package:  $P_{tot}$  derates linearly with 3.3 mW/K above 74 °C.

For SOT753 (SC-74A) package:  $P_{tot}$  derates linearly with 3.8 mW/K above 85 °C.

For SOT886 (XSON6) package:  $P_{tot}$  derates linearly with 3.3 mW/K above 74 °C.

For SOT1115 (XSON6) package:  $P_{tot}$  derates linearly with 3.2 mW/K above 71 °C.

For SOT1202 (XSON6) package:  $P_{tot}$  derates linearly with 3.3 mW/K above 74 °C.

For SOT1226-3 (X2SON5) package:  $P_{tot}$  derates linearly with 3.0 mW/K above 67 °C.

## 9. Recommended operating conditions

**Table 6. Recommended operating conditions**

Symbol	Parameter	Conditions	Min	Typ	Max	Unit
$V_{CC}$	supply voltage		1.65	-	5.5	V
$V_I$	input voltage		0	-	5.5	V
$V_{SW}$	switch voltage	[1]	0	-	$V_{CC}$	V
$T_{amb}$	ambient temperature		-40	-	+125	°C
$\Delta t/\Delta V$	input transition rise and fall rate	$V_{CC} = 1.65\text{ V}$ to $2.7\text{ V}$	-	-	20	ns/V
		$V_{CC} = 2.7\text{ V}$ to $5.5\text{ V}$	-	-	10	ns/V

[1] To avoid sinking GND current from terminal Z when switch current flows in terminal Y, the voltage drop across the bidirectional switch must not exceed 0.4 V. If the switch current flows into terminal Z, no GND current will flow from terminal Y. In this case, there is no limit for the voltage drop across the switch.

## 10. Static characteristics

**Table 7. Static characteristics**

At recommended operating conditions; voltages are referenced to GND (ground = 0 V).

Symbol	Parameter	Conditions	-40 °C to +85 °C			-40 °C to +125 °C		Unit
			Min	Typ[1]	Max	Min	Max	
V <sub>IH</sub>	HIGH-level input voltage	V <sub>CC</sub> = 1.65 V to 1.95 V	0.65 × V <sub>CC</sub>	-	-	0.65 × V <sub>CC</sub>	-	V
		V <sub>CC</sub> = 2.3 V to 2.7 V	1.7	-	-	1.7	-	V
		V <sub>CC</sub> = 2.7 V to 3.6 V	2.0	-	-	2.0	-	V
		V <sub>CC</sub> = 4.5 V to 5.5 V	0.7 × V <sub>CC</sub>	-	-	0.7 × V <sub>CC</sub>	-	V
V <sub>IL</sub>	LOW-level input voltage	V <sub>CC</sub> = 1.65 V to 1.95 V	-	-	0.35 × V <sub>CC</sub>	-	0.35 × V <sub>CC</sub>	V
		V <sub>CC</sub> = 2.3 V to 2.7 V	-	-	0.7	-	0.7	V
		V <sub>CC</sub> = 2.7 V to 3.6 V	-	-	0.8	-	0.8	V
		V <sub>CC</sub> = 4.5 V to 5.5 V	-	-	0.3 × V <sub>CC</sub>	-	0.3 × V <sub>CC</sub>	V
I <sub>I</sub>	input leakage current	pin $\bar{E}$ ; V <sub>I</sub> = 5.5 V or GND; V <sub>CC</sub> = 0 V to 5.5 V [2]	-	±0.1	±1	-	±1	µA
I <sub>S(OFF)</sub>	OFF-state leakage current	V <sub>CC</sub> = 5.5 V; see Fig. 8 [2]	-	±0.1	±0.2	-	±0.5	µA
I <sub>S(ON)</sub>	ON-state leakage current	V <sub>CC</sub> = 5.5 V; see Fig. 9 [2]	-	±0.1	±1	-	±2	µA
I <sub>CC</sub>	supply current	V <sub>I</sub> = 5.5 V or GND; V <sub>SW</sub> = GND or V <sub>CC</sub> ; V <sub>CC</sub> = 1.65 V to 5.5 V [2]	-	0.1	4	-	4	µA
ΔI <sub>CC</sub>	additional supply current	pin $\bar{E}$ ; V <sub>I</sub> = V <sub>CC</sub> - 0.6 V; V <sub>SW</sub> = GND or V <sub>CC</sub> ; V <sub>CC</sub> = 5.5 V [2]	-	5	500	-	500	µA
C <sub>I</sub>	input capacitance		-	2.0	-	-	-	pF
C <sub>S(OFF)</sub>	OFF-state capacitance		-	5.0	-	-	-	pF
C <sub>S(ON)</sub>	ON-state capacitance		-	9.5	-	-	-	pF

- [1] All typical values are measured at T<sub>amb</sub> = 25 °C.
- [2] These typical values are measured at V<sub>CC</sub> = 3.3 V.

### 10.1. Test circuits

V<sub>I</sub> = V<sub>CC</sub> or GND and V<sub>O</sub> = GND or V<sub>CC</sub>.

**Fig. 8. Test circuit for measuring OFF-state leakage current**

V<sub>I</sub> = V<sub>CC</sub> or GND and V<sub>O</sub> = open circuit.

**Fig. 9. Test circuit for measuring ON-state leakage current**

## 10.2. ON resistance

**Table 8. ON resistance**

At recommended operating conditions; voltages are referenced to GND (ground 0 V); for graphs see Fig. 11 to Fig. 16.

Symbol	Parameter	Conditions	-40 °C to +85 °C			-40 °C to +125 °C		Unit		
			Min	Typ[1]	Max	Min	Max			
R <sub>ON(peak)</sub>	ON resistance (peak)	V <sub>I</sub> = GND to V <sub>CC</sub> ; see Fig. 10								
		I <sub>SW</sub> = 4 mA; V <sub>CC</sub> = 1.65 V to 1.95 V	-	34.0	130	-	195	Ω		
		I <sub>SW</sub> = 8 mA; V <sub>CC</sub> = 2.3 V to 2.7 V	-	12.0	30	-	45	Ω		
		I <sub>SW</sub> = 12 mA; V <sub>CC</sub> = 2.7 V	-	10.4	25	-	38	Ω		
		I <sub>SW</sub> = 24 mA; V <sub>CC</sub> = 3 V to 3.6 V	-	7.8	20	-	30	Ω		
		I <sub>SW</sub> = 32 mA; V <sub>CC</sub> = 4.5 V to 5.5 V	-	6.2	15	-	23	Ω		
R <sub>ON(rail)</sub>	ON resistance (rail)	V <sub>I</sub> = GND; see Fig. 10								
		I <sub>SW</sub> = 4 mA; V <sub>CC</sub> = 1.65 V to 1.95 V	-	8.2	18	-	27	Ω		
		I <sub>SW</sub> = 8 mA; V <sub>CC</sub> = 2.3 V to 2.7 V	-	7.1	16	-	24	Ω		
		I <sub>SW</sub> = 12 mA; V <sub>CC</sub> = 2.7 V	-	6.9	14	-	21	Ω		
		I <sub>SW</sub> = 24 mA; V <sub>CC</sub> = 3 V to 3.6 V	-	6.5	12	-	18	Ω		
		I <sub>SW</sub> = 32 mA; V <sub>CC</sub> = 4.5 V to 5.5 V	-	5.8	10	-	15	Ω		
		V <sub>I</sub> = V <sub>CC</sub> ; see Fig. 10				-				
		I <sub>SW</sub> = 4 mA; V <sub>CC</sub> = 1.65 V to 1.95 V	-	10.4	30	-	45	Ω		
		I <sub>SW</sub> = 8 mA; V <sub>CC</sub> = 2.3 V to 2.7 V	-	7.6	20	-	30	Ω		
		I <sub>SW</sub> = 12 mA; V <sub>CC</sub> = 2.7 V	-	7.0	18	-	27	Ω		
		I <sub>SW</sub> = 24 mA; V <sub>CC</sub> = 3 V to 3.6 V	-	6.1	15	-	23	Ω		
		I <sub>SW</sub> = 32 mA; V <sub>CC</sub> = 4.5 V to 5.5 V	-	4.9	10	-	15	Ω		
		R <sub>ON(flat)</sub>	ON resistance (flatness)	V <sub>I</sub> = GND to V <sub>CC</sub> [2]						
				I <sub>SW</sub> = 4 mA; V <sub>CC</sub> = 1.65 V to 1.95 V	-	26.0	-	-	-	Ω
I <sub>SW</sub> = 8 mA; V <sub>CC</sub> = 2.3 V to 2.7 V	-			5.0	-	-	-	Ω		
I <sub>SW</sub> = 12 mA; V <sub>CC</sub> = 2.7 V	-			3.5	-	-	-	Ω		
I <sub>SW</sub> = 24 mA; V <sub>CC</sub> = 3 V to 3.6 V	-			2.0	-	-	-	Ω		
I <sub>SW</sub> = 32 mA; V <sub>CC</sub> = 4.5 V to 5.5 V	-			1.5	-	-	-	Ω		

[1] Typical values are measured at T<sub>amb</sub> = 25 °C and nominal V<sub>CC</sub>.

[2] Flatness is defined as the difference between the maximum and minimum value of ON resistance measured at identical V<sub>CC</sub> and temperature.

10.3. ON resistance test circuit and graphs

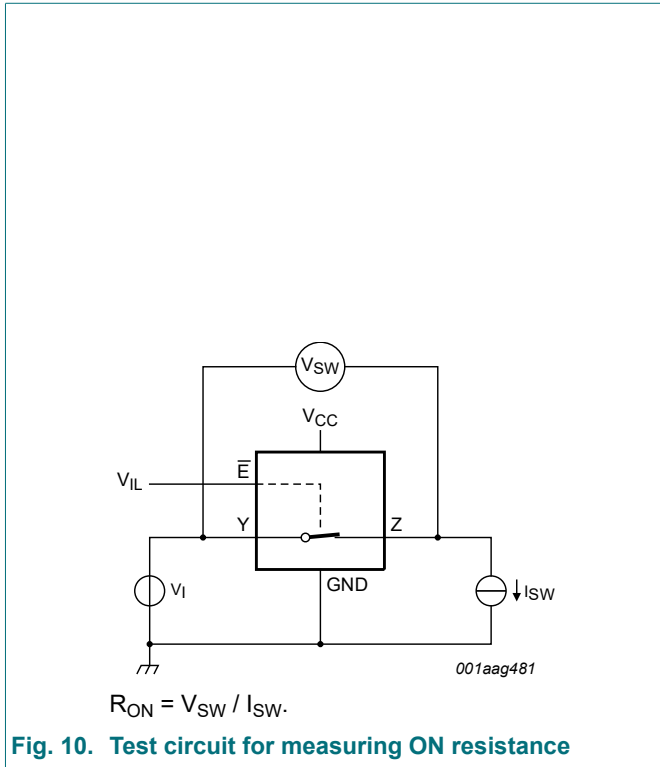

Fig. 10. Test circuit for measuring ON resistance

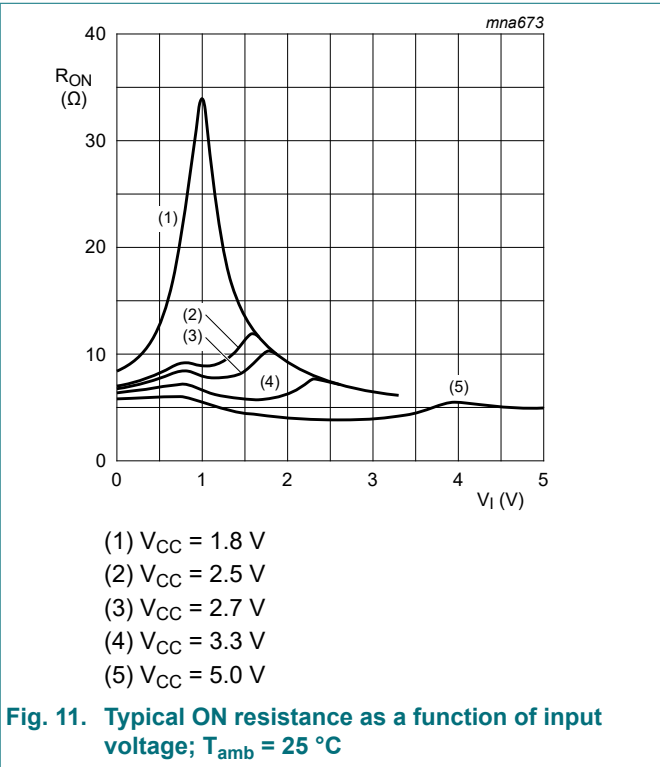

Fig. 11. Typical ON resistance as a function of input voltage;  $T_{amb} = 25\text{ }^{\circ}\text{C}$

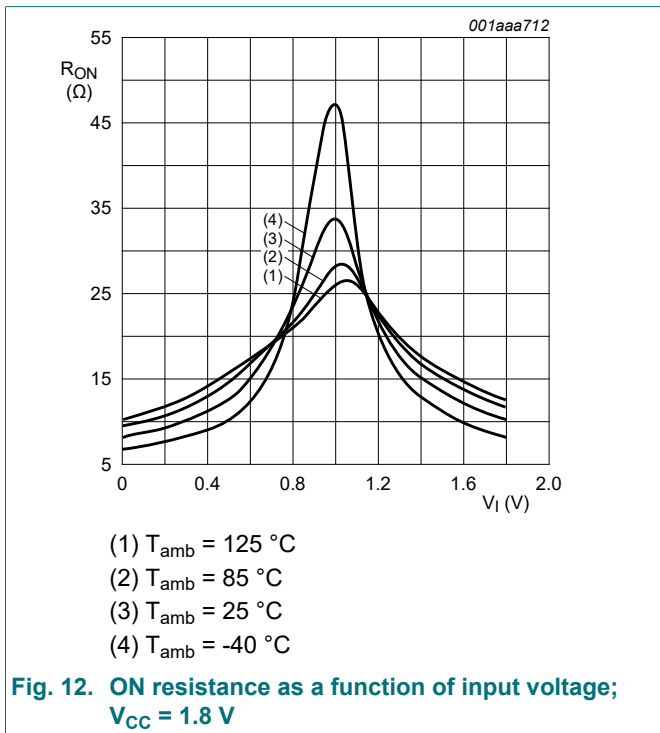

Fig. 12. ON resistance as a function of input voltage;  $V_{CC} = 1.8\text{ V}$

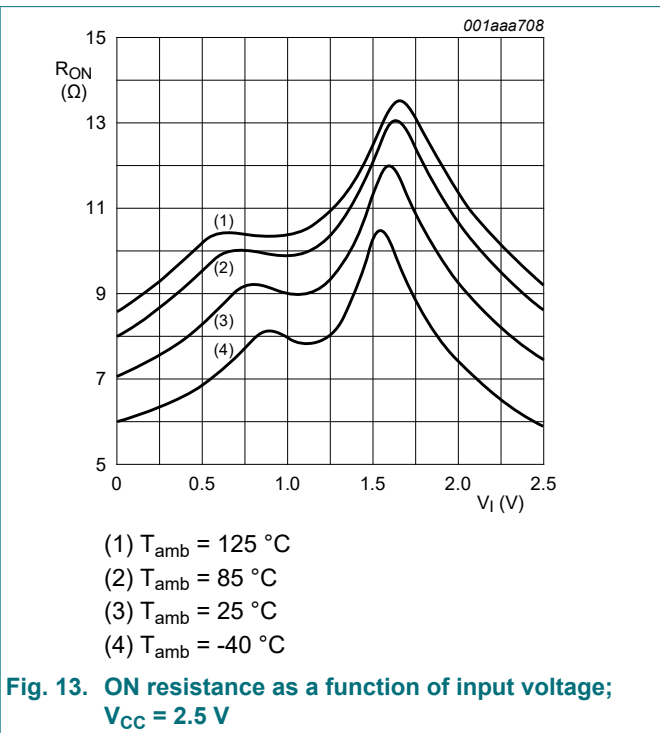
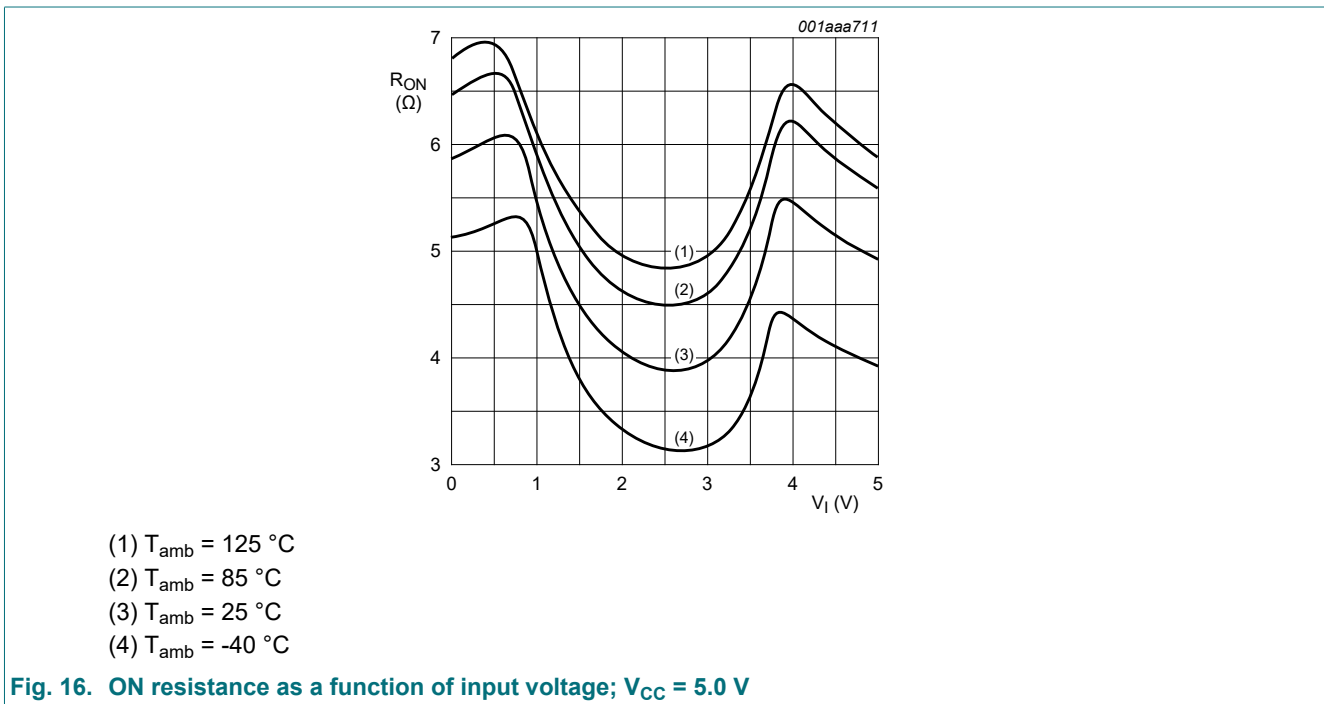
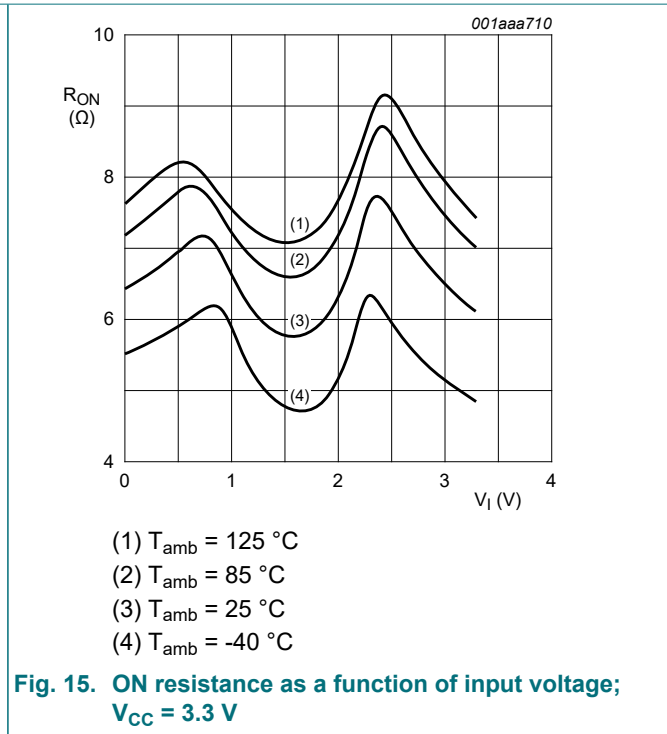
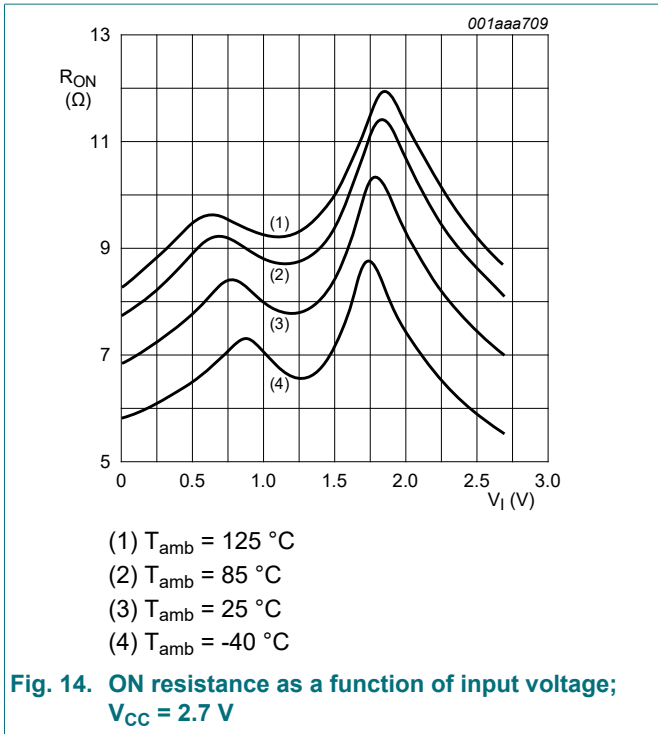

Fig. 13. ON resistance as a function of input voltage;  $V_{CC} = 2.5\text{ V}$





## 11. Dynamic characteristics

**Table 9. Dynamic characteristics**

At recommended operating conditions; voltages are referenced to GND (ground = 0 V); for test circuit see Fig. 19.

Symbol	Parameter	Conditions	-40 °C to +85 °C			-40 °C to +125 °C		Unit
			Min	Typ[1]	Max	Min	Max	
t <sub>pd</sub>	propagation delay	Y to Z or Z to Y; see Fig. 17 [2][3]						
		V <sub>CC</sub> = 1.65 V to 1.95 V	-	0.8	2.0	-	3.0	ns
		V <sub>CC</sub> = 2.3 V to 2.7 V	-	0.4	1.2	-	2.0	ns
		V <sub>CC</sub> = 2.7 V	-	0.4	1.0	-	1.5	ns
		V <sub>CC</sub> = 3.0 V to 3.6 V	-	0.3	0.8	-	1.5	ns
		V <sub>CC</sub> = 4.5 V to 5.5 V	-	0.2	0.6	-	1.0	ns
t <sub>en</sub>	enable time	$\bar{E}$ to Y or Z; see Fig. 18 [4]						
		V <sub>CC</sub> = 1.65 V to 1.95 V	1.0	10.0	12.0	1.0	15.5	ns
		V <sub>CC</sub> = 2.3 V to 2.7 V	1.0	5.7	6.5	1.0	8.5	ns
		V <sub>CC</sub> = 2.7 V	1.0	5.4	6.0	1.0	8.0	ns
		V <sub>CC</sub> = 3.0 V to 3.6 V	1.0	4.8	5.0	1.0	6.5	ns
		V <sub>CC</sub> = 4.5 V to 5.5 V	1.0	3.3	4.2	1.0	5.5	ns
t <sub>dis</sub>	disable time	$\bar{E}$ to Y or Z; see Fig. 18 [5]						
		V <sub>CC</sub> = 1.65 V to 1.95 V	1.0	7.4	10.0	1.0	13.0	ns
		V <sub>CC</sub> = 2.3 V to 2.7 V	1.0	4.1	6.9	1.0	9.0	ns
		V <sub>CC</sub> = 2.7 V	1.0	4.9	7.5	1.0	9.5	ns
		V <sub>CC</sub> = 3.0 V to 3.6 V	1.0	5.4	6.5	1.0	8.5	ns
		V <sub>CC</sub> = 4.5 V to 5.5 V	1.0	3.6	5.0	1.0	6.5	ns
C <sub>PD</sub>	power dissipation capacitance	C <sub>L</sub> = 50 pF; f <sub>i</sub> = 10 MHz; V <sub>I</sub> = GND to V <sub>CC</sub> [6]						
		V <sub>CC</sub> = 2.5 V	-	13.7	-	-	-	pF
		V <sub>CC</sub> = 3.3 V	-	15.2	-	-	-	pF
		V <sub>CC</sub> = 5.0 V	-	18.3	-	-	-	pF

[1] Typical values are measured at T<sub>amb</sub> = 25 °C and nominal V<sub>CC</sub>.

[2] Propagation delay is the calculated RC time constant of the typical ON resistance of the switch and the specified capacitance when driven by an ideal voltage source (zero output impedance).

[3] t<sub>pd</sub> is the same as t<sub>PLH</sub> and t<sub>PHL</sub>.

[4] t<sub>en</sub> is the same as t<sub>PZH</sub> and t<sub>PZL</sub>.

[5] t<sub>dis</sub> is the same as t<sub>PLZ</sub> and t<sub>PHZ</sub>.

[6] C<sub>PD</sub> is used to determine the dynamic power dissipation (P<sub>D</sub> in μW).

$$P_D = C_{PD} \times V_{CC}^2 \times f_i \times N + \Sigma\{(C_L + C_{S(ON)}) \times V_{CC}^2 \times f_o\} \text{ where:}$$

f<sub>i</sub> = input frequency in MHz;

f<sub>o</sub> = output frequency in MHz;

C<sub>L</sub> = output load capacitance in pF;

C<sub>S(ON)</sub> = maximum ON-state switch capacitance in pF;

V<sub>CC</sub> = supply voltage in V;

N = number of inputs switching;

Σ{(C<sub>L</sub> + C<sub>S(ON)</sub>) × V<sub>CC</sub><sup>2</sup> × f<sub>o</sub>} = sum of the outputs.

11.1. Waveforms and test circuit

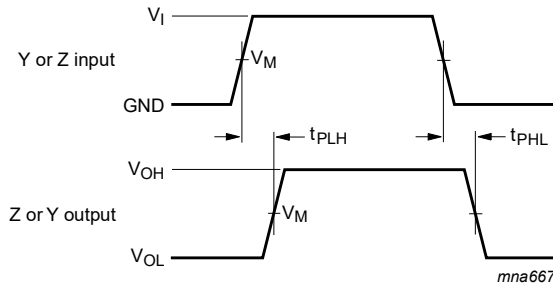

Measurement points are given in [Table 10](#).

Logic levels:  $V_{OL}$  and  $V_{OH}$  are typical output voltage levels that occur with the output load.

Fig. 17. Input (Y or Z) to output (Z or Y) propagation delays

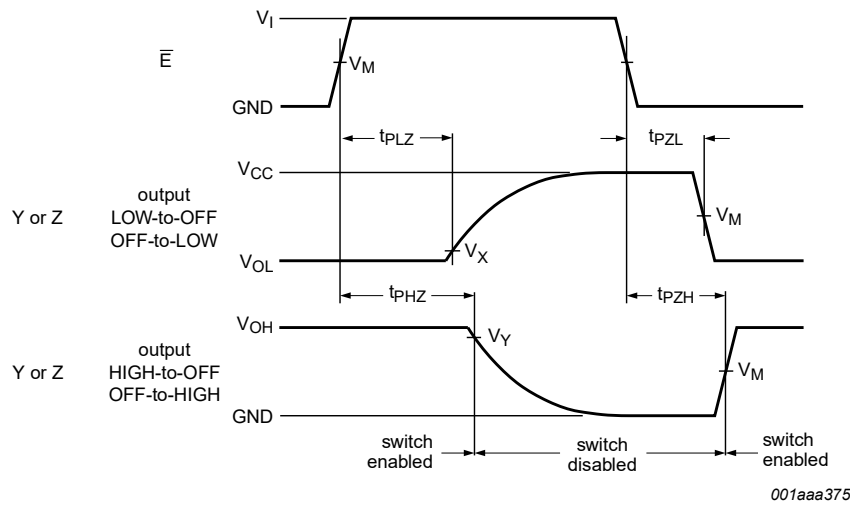

Measurement points are given in [Table 10](#).

Logic levels:  $V_{OL}$  and  $V_{OH}$  are typical output voltage levels that occur with the output load.

Fig. 18. Enable and disable times

Table 10. Measurement points

Supply voltage	Input	Output		
$V_{CC}$	$V_M$	$V_M$	$V_X$	$V_Y$
1.65 V to 1.95 V	$0.5 \times V_{CC}$	$0.5 \times V_{CC}$	$V_{OL} + 0.15 \text{ V}$	$V_{OH} - 0.15 \text{ V}$
2.3 V to 2.7 V	$0.5 \times V_{CC}$	$0.5 \times V_{CC}$	$V_{OL} + 0.15 \text{ V}$	$V_{OH} - 0.15 \text{ V}$
2.7 V	1.5 V	1.5 V	$V_{OL} + 0.3 \text{ V}$	$V_{OH} - 0.3 \text{ V}$
3.0 V to 3.6 V	1.5 V	1.5 V	$V_{OL} + 0.3 \text{ V}$	$V_{OH} - 0.3 \text{ V}$
4.5 V to 5.5 V	$0.5 \times V_{CC}$	$0.5 \times V_{CC}$	$V_{OL} + 0.3 \text{ V}$	$V_{OH} - 0.3 \text{ V}$

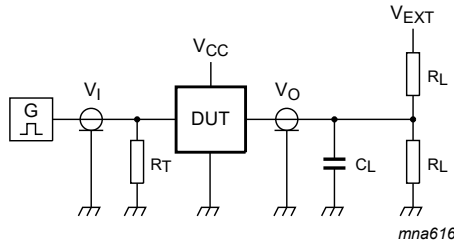

Test data is given in [Table 11](#).

Definitions for test circuit:

$R_T$  = Termination resistance should be equal to output impedance  $Z_o$  of the pulse generator;

$C_L$  = Load capacitance including jig and probe capacitance;

$R_L$  = Load resistance;

$V_{EXT}$  = External voltage for measuring switching times.

**Fig. 19. Test circuit for measuring switching times**

**Table 11. Test data**

Supply voltage	Input		Load		$V_{EXT}$		
$V_{CC}$	$V_I$	$t_r, t_f$	$C_L$	$R_L$	$t_{PLH}, t_{PHL}$	$t_{PZH}, t_{PHZ}$	$t_{PZL}, t_{PLZ}$
1.65 V to 1.95 V	$V_{CC}$	$\leq 2.0$ ns	30 pF	1 k $\Omega$	open	GND	$2 \times V_{CC}$
2.3 V to 2.7 V	$V_{CC}$	$\leq 2.0$ ns	30 pF	500 $\Omega$	open	GND	$2 \times V_{CC}$
2.7 V	2.7 V	$\leq 2.5$ ns	50 pF	500 $\Omega$	open	GND	6 V
3.0 V to 3.6 V	2.7 V	$\leq 2.5$ ns	50 pF	500 $\Omega$	open	GND	6 V
4.5 V to 5.5 V	$V_{CC}$	$\leq 2.5$ ns	50 pF	500 $\Omega$	open	GND	$2 \times V_{CC}$

## 11.2. Additional dynamic characteristics

**Table 12. Additional dynamic characteristics**

At recommended operating conditions; typical values measured at  $T_{amb} = 25$  °C.

Symbol	Parameter	Conditions	Min	Typ	Max	Unit	
THD	total harmonic distortion	$R_L = 10$ k $\Omega$ ; $C_L = 50$ pF; $f_i = 1$ kHz; see <a href="#">Fig. 20</a>					
		$V_{CC} = 1.65$ V	-	0.032	-	%	
		$V_{CC} = 2.3$ V	-	0.008	-	%	
		$V_{CC} = 3.0$ V	-	0.006	-	%	
		$V_{CC} = 4.5$ V	-	0.001	-	%	
		$R_L = 10$ k $\Omega$ ; $C_L = 50$ pF; $f_i = 10$ kHz; see <a href="#">Fig. 20</a>					
		$V_{CC} = 1.65$ V	-	0.068	-	%	
		$V_{CC} = 2.3$ V	-	0.009	-	%	
		$V_{CC} = 3.0$ V	-	0.008	-	%	
		$V_{CC} = 4.5$ V	-	0.006	-	%	

Symbol	Parameter	Conditions	Min	Typ	Max	Unit
$f_{(-3dB)}$	-3 dB frequency response	$R_L = 600 \Omega$ ; $C_L = 50 \text{ pF}$ ; see <a href="#">Fig. 21</a>				
		$V_{CC} = 1.65 \text{ V}$	-	135	-	MHz
		$V_{CC} = 2.3 \text{ V}$	-	145	-	MHz
		$V_{CC} = 3.0 \text{ V}$	-	150	-	MHz
		$V_{CC} = 4.5 \text{ V}$	-	155	-	MHz
		$R_L = 50 \Omega$ ; $C_L = 5 \text{ pF}$ ; see <a href="#">Fig. 21</a>				
		$V_{CC} = 1.65 \text{ V}$	-	> 500	-	MHz
		$V_{CC} = 2.3 \text{ V}$	-	> 500	-	MHz
		$V_{CC} = 3.0 \text{ V}$	-	> 500	-	MHz
		$V_{CC} = 4.5 \text{ V}$	-	> 500	-	MHz
		$R_L = 50 \Omega$ ; $C_L = 10 \text{ pF}$ ; see <a href="#">Fig. 21</a>				
		$V_{CC} = 1.65 \text{ V}$	-	200	-	MHz
		$V_{CC} = 2.3 \text{ V}$	-	350	-	MHz
		$V_{CC} = 3.0 \text{ V}$	-	410	-	MHz
$V_{CC} = 4.5 \text{ V}$	-	440	-	MHz		
$\alpha_{iso}$	isolation (OFF-state)	$R_L = 600 \Omega$ ; $C_L = 50 \text{ pF}$ ; $f_i = 1 \text{ MHz}$ ; see <a href="#">Fig. 22</a>				
		$V_{CC} = 1.65 \text{ V}$	-	-46	-	dB
		$V_{CC} = 2.3 \text{ V}$	-	-46	-	dB
		$V_{CC} = 3.0 \text{ V}$	-	-46	-	dB
		$V_{CC} = 4.5 \text{ V}$	-	-46	-	dB
		$R_L = 50 \Omega$ ; $C_L = 5 \text{ pF}$ ; $f_i = 1 \text{ MHz}$ ; see <a href="#">Fig. 22</a>				
		$V_{CC} = 1.65 \text{ V}$	-	-37	-	dB
		$V_{CC} = 2.3 \text{ V}$	-	-37	-	dB
		$V_{CC} = 3.0 \text{ V}$	-	-37	-	dB
		$V_{CC} = 4.5 \text{ V}$	-	-37	-	dB
$V_{ct}$	crosstalk voltage	between digital input and switch; $R_L = 600 \Omega$ ; $C_L = 50 \text{ pF}$ ; $f_i = 1 \text{ MHz}$ ; $t_r = t_f = 2 \text{ ns}$ ; see <a href="#">Fig. 23</a>				
		$V_{CC} = 1.65 \text{ V}$	-	69	-	mV
		$V_{CC} = 2.3 \text{ V}$	-	87	-	mV
		$V_{CC} = 3.0 \text{ V}$	-	156	-	mV
		$V_{CC} = 4.5 \text{ V}$	-	302	-	mV
$Q_{inj}$	charge injection	$C_L = 0.1 \text{ nF}$ ; $V_{gen} = 0 \text{ V}$ ; $R_{gen} = 0 \Omega$ ; $f_i = 1 \text{ MHz}$ ; $R_L = 1 \text{ M}\Omega$ ; see <a href="#">Fig. 24</a>				
		$V_{CC} = 1.8 \text{ V}$	-	3.3	-	pC
		$V_{CC} = 2.5 \text{ V}$	-	4.1	-	pC
		$V_{CC} = 3.3 \text{ V}$	-	5.0	-	pC
		$V_{CC} = 4.5 \text{ V}$	-	6.4	-	pC
		$V_{CC} = 5.5 \text{ V}$	-	7.5	-	pC

11.3. Test circuits

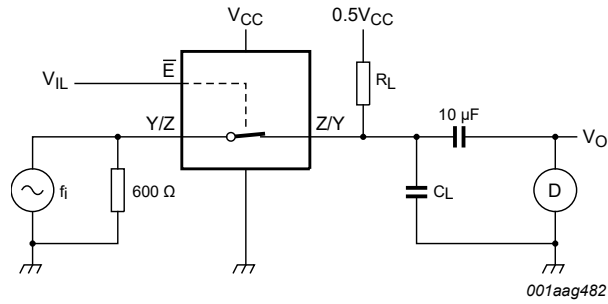

**Test conditions:**

- $V_{CC} = 1.65\text{ V}$ :  $V_I = 1.4\text{ V (p-p)}$
- $V_{CC} = 2.3\text{ V}$ :  $V_I = 2\text{ V (p-p)}$
- $V_{CC} = 3\text{ V}$ :  $V_I = 2.5\text{ V (p-p)}$
- $V_{CC} = 4.5\text{ V}$ :  $V_I = 4\text{ V (p-p)}$

**Fig. 20. Test circuit for measuring total harmonic distortion**

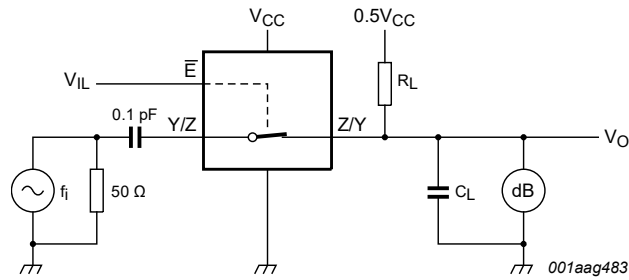

Adjust  $f_i$  voltage to obtain 0 dBm level at output. Increase  $f_i$  frequency until dB meter reads -3 dB.

**Fig. 21. Test circuit for measuring the frequency response when switch is in ON-state**

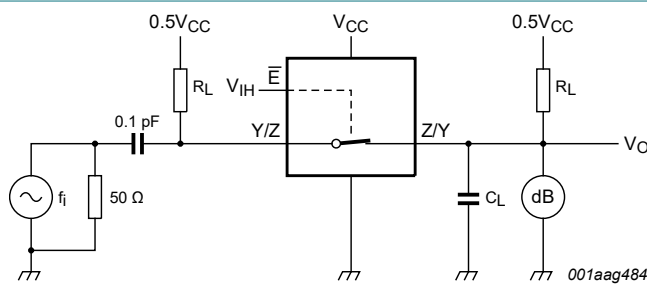

Adjust  $f_i$  voltage to obtain 0 dBm level at input.

**Fig. 22. Test circuit for measuring isolation (OFF-state)**

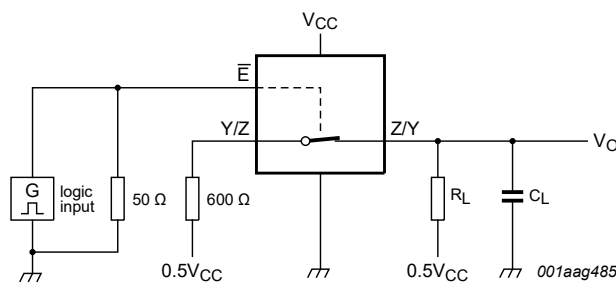

**Fig. 23. Test circuit for measuring crosstalk between digital inputs and switch**

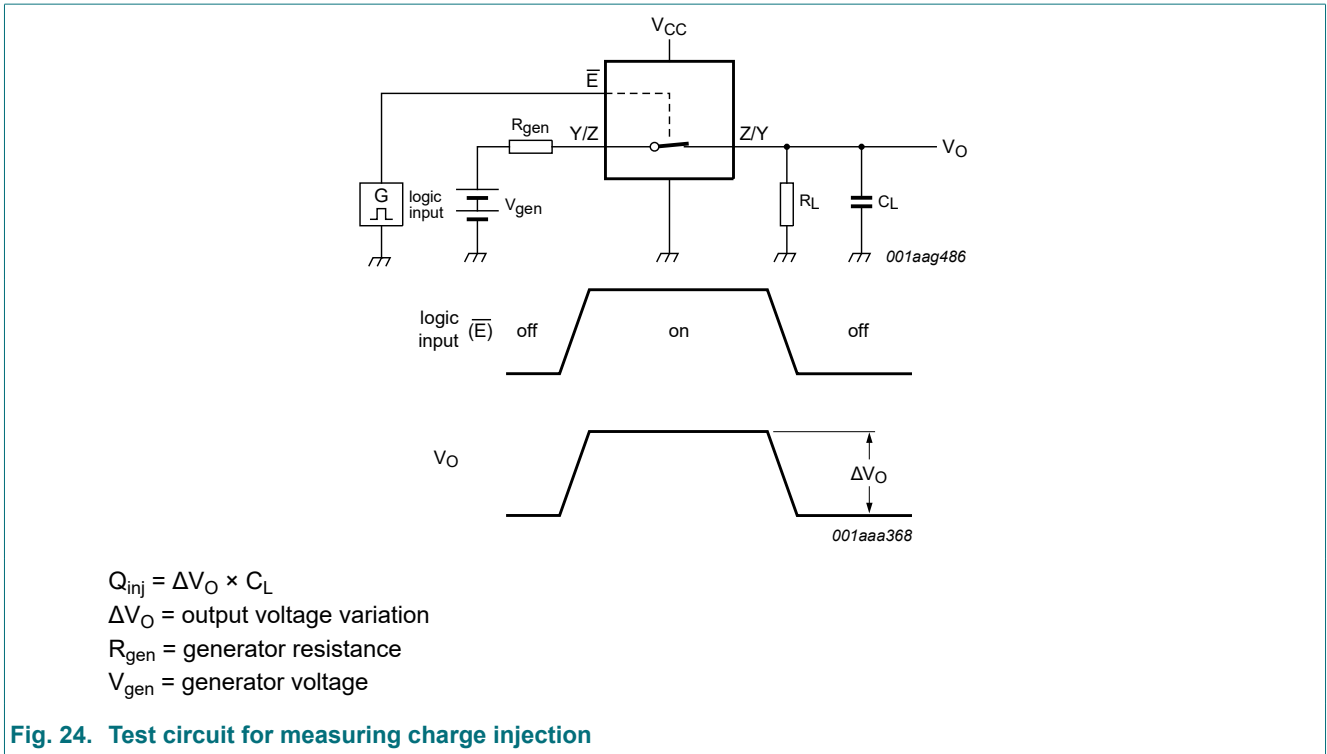

Fig. 24. Test circuit for measuring charge injection

## 12. Package outline

TSSOP5: plastic thin shrink small outline package; 5 leads; body width 1.25 mm

SOT353-1



Fig. 25. Package outline SOT353-1 (TSSOP5)

Plastic surface-mounted package; 5 leads

SOT753

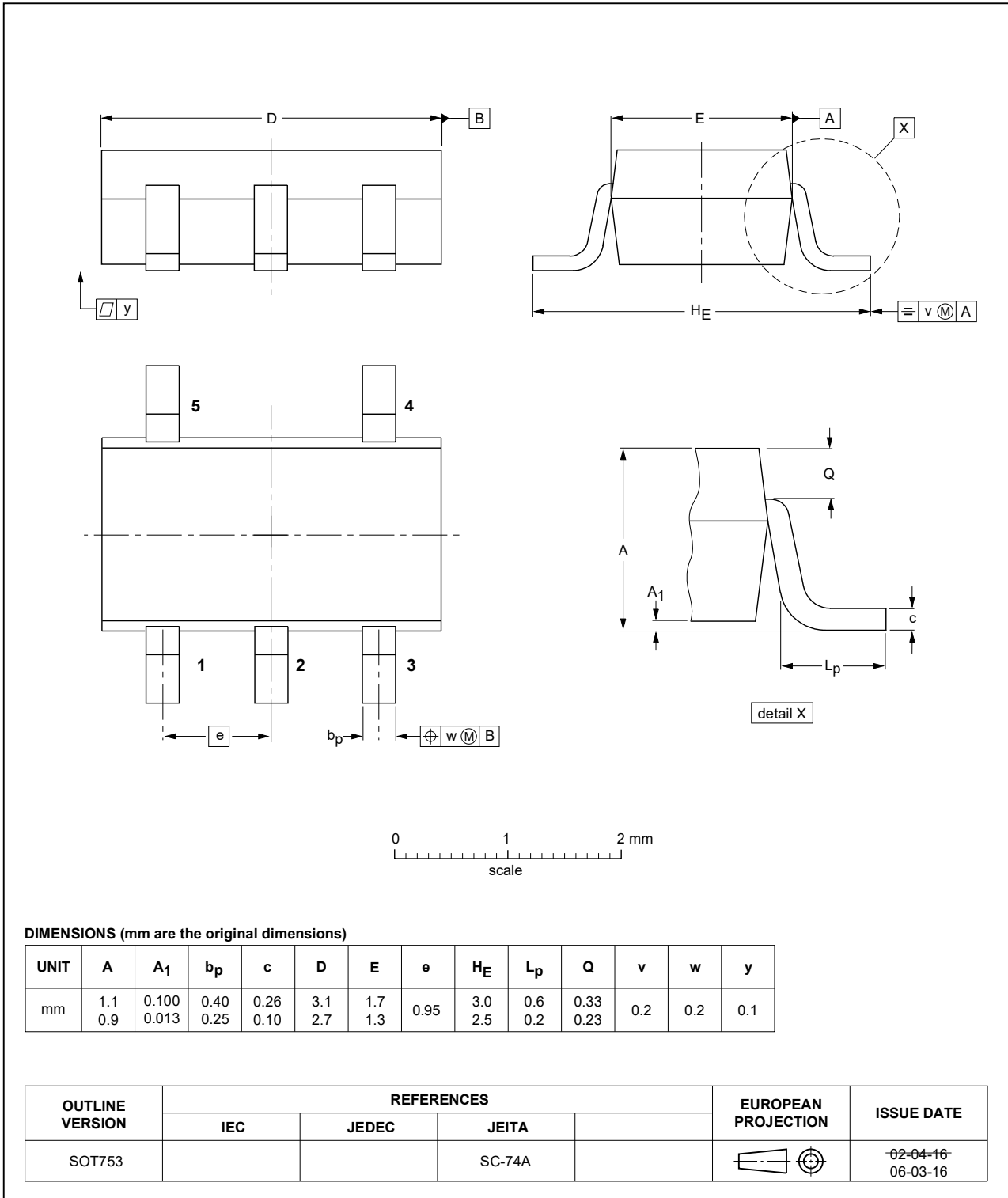

Fig. 26. Package outline SOT753 (SC-74A)



XSON6: plastic extremely thin small outline package; no leads; 6 terminals; body 1 x 1.45 x 0.5 mm

SOT886

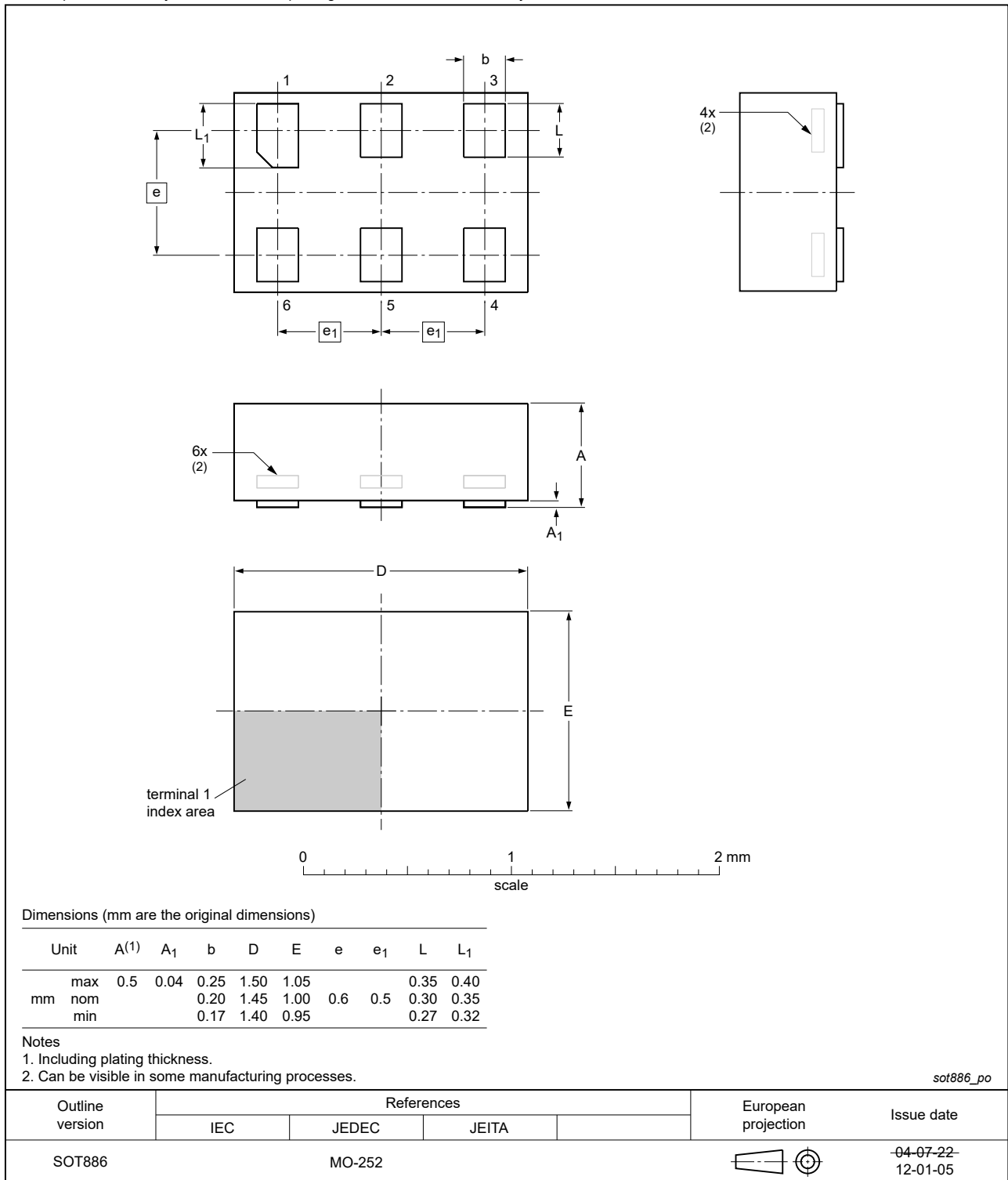
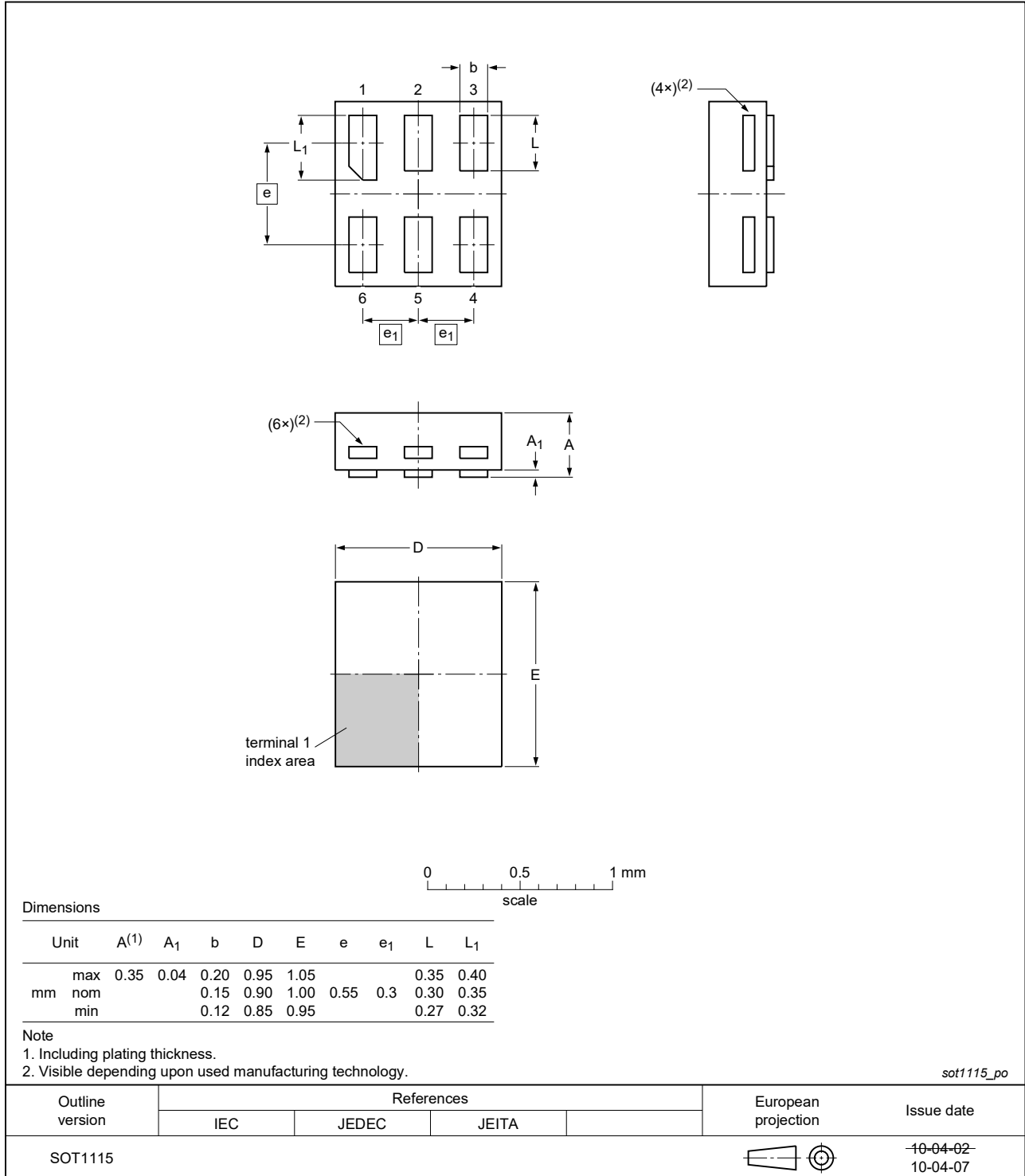

Fig. 27. Package outline SOT886 (XSON6)

**XSON6: extremely thin small outline package; no leads;**  
**6 terminals; body 0.9 x 1.0 x 0.35 mm**

SOT1115



**Fig. 28. Package outline SOT1115 (XSON6)**

XSON6: extremely thin small outline package; no leads;  
6 terminals; body 1.0 x 1.0 x 0.35 mm

SOT1202

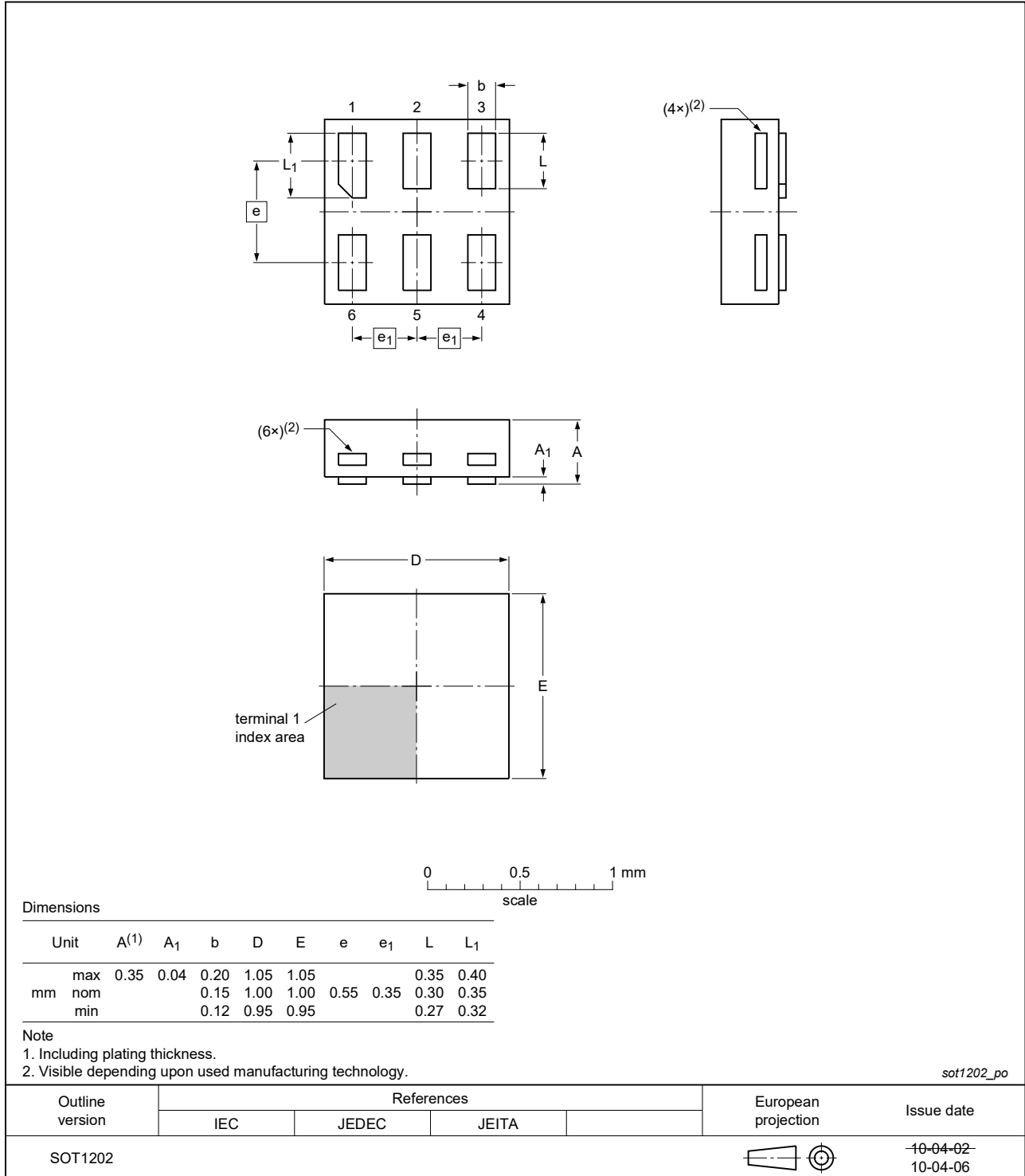

Fig. 29. Package outline SOT1202 (XSON6)

X2SON5: plastic thermal enhanced extremely thin small outline package; no leads;  
5 terminals; body 0.8 x 0.8 x 0.32 mm

SOT1226-3

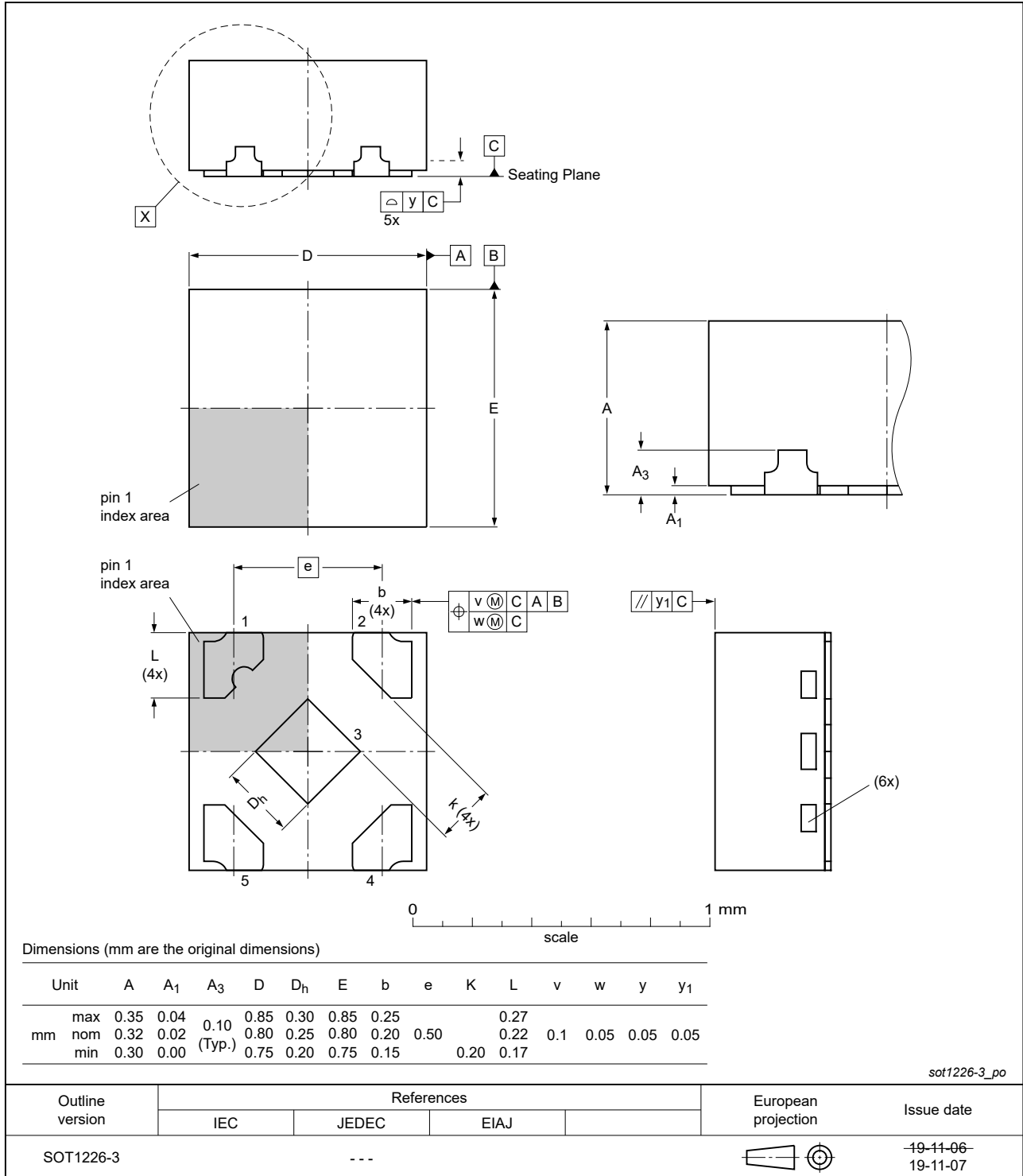

Fig. 30. Package outline SOT1226-3 (X2SON5)

## 13. Abbreviations

Table 13. Abbreviations

Acronym	Description
CMOS	Complementary Metal Oxide Semiconductor
DUT	Device Under Test
ESD	ElectroStatic Discharge
HBM	Human Body Model
MM	Machine Model
TTL	Transistor-Transistor Logic

## 14. Revision history

Table 14. Revision history

Document ID	Release date	Data sheet status	Change notice	Supersedes
74LVC1G384 v.9	20220816	Product data sheet	-	74LVC1G384 v.8
Modifications:	<ul style="list-style-type: none"> <li>Package SOT1226 (X2SON5) has changed to SOT1226-3 (X2SON5).</li> </ul>			
74LVC1G384 v.8	20220208	Product data sheet	-	74LVC1G384 v.7
Modifications:	<ul style="list-style-type: none"> <li>The format of this data sheet has been redesigned to comply with the identity guidelines of Nexperia.</li> <li>Legal texts have been adapted to the new company name where appropriate.</li> <li><a href="#">Section 1</a> and <a href="#">Section 2</a> updated.</li> <li><a href="#">Table 5</a>: Derating values for <math>P_{tot}</math> total power dissipation updated.</li> <li><a href="#">Fig. 25</a>: Package outline drawing SOT353-1 (TSSOP5) has changed.</li> <li>Type number 74LVC1G384GF (SOT891/XSON6) removed.</li> </ul>			
74LVC1G384 v.7	20161207	Product data sheet	-	74LVC1G384 v.6
Modifications:	<ul style="list-style-type: none"> <li><a href="#">Table 7</a>: The maximum limits for leakage current and supply current have changed.</li> </ul>			
74LVC1G384 v.6	20150903	Product data sheet	-	74LVC1G384 v.5
Modifications:	<ul style="list-style-type: none"> <li>Added type number 74LVC1G384GX (SOT1226)</li> </ul>			
74LVC1G384 v.5	20150115	Product data sheet	-	74LVC1G384 v.4
Modifications:	<ul style="list-style-type: none"> <li>SOT886 (XSON6) package outline drawing modified.</li> </ul>			
74LVC1G384 v.4	20111206	Product data sheet	-	74LVC1G384 v.3
Modifications:	<ul style="list-style-type: none"> <li>Legal pages updated.</li> </ul>			
74LVC1G384 v.3	20101103	Product data sheet	-	74LVC1G384 v.2
74LVC1G384 v.2	20070829	Product data sheet	-	74LVC1G384 v.1
74LVC1G384 v.1	20040226	Product data sheet	-	-

## 15. Legal information

### Data sheet status

Document status [1][2]	Product status [3]	Definition
Objective [short] data sheet	Development	This document contains data from the objective specification for product development.
Preliminary [short] data sheet	Qualification	This document contains data from the preliminary specification.
Product [short] data sheet	Production	This document contains the product specification.

- [1] Please consult the most recently issued document before initiating or completing a design.
- [2] The term 'short data sheet' is explained in section "Definitions".
- [3] The product status of device(s) described in this document may have changed since this document was published and may differ in case of multiple devices. The latest product status information is available on the internet at <https://www.nexperia.com>.

### Definitions

**Draft** — The document is a draft version only. The content is still under internal review and subject to formal approval, which may result in modifications or additions. Nexperia does not give any representations or warranties as to the accuracy or completeness of information included herein and shall have no liability for the consequences of use of such information.

**Short data sheet** — A short data sheet is an extract from a full data sheet with the same product type number(s) and title. A short data sheet is intended for quick reference only and should not be relied upon to contain detailed and full information. For detailed and full information see the relevant full data sheet, which is available on request via the local Nexperia sales office. In case of any inconsistency or conflict with the short data sheet, the full data sheet shall prevail.

**Product specification** — The information and data provided in a Product data sheet shall define the specification of the product as agreed between Nexperia and its customer, unless Nexperia and customer have explicitly agreed otherwise in writing. In no event however, shall an agreement be valid in which the Nexperia product is deemed to offer functions and qualities beyond those described in the Product data sheet.

### Disclaimers

**Limited warranty and liability** — Information in this document is believed to be accurate and reliable. However, Nexperia does not give any representations or warranties, expressed or implied, as to the accuracy or completeness of such information and shall have no liability for the consequences of use of such information. Nexperia takes no responsibility for the content in this document if provided by an information source outside of Nexperia.

In no event shall Nexperia be liable for any indirect, incidental, punitive, special or consequential damages (including - without limitation - lost profits, lost savings, business interruption, costs related to the removal or replacement of any products or rework charges) whether or not such damages are based on tort (including negligence), warranty, breach of contract or any other legal theory.

Notwithstanding any damages that customer might incur for any reason whatsoever, Nexperia's aggregate and cumulative liability towards customer for the products described herein shall be limited in accordance with the Terms and conditions of commercial sale of Nexperia.

**Right to make changes** — Nexperia reserves the right to make changes to information published in this document, including without limitation specifications and product descriptions, at any time and without notice. This document supersedes and replaces all information supplied prior to the publication hereof.

**Suitability for use** — Nexperia products are not designed, authorized or warranted to be suitable for use in life support, life-critical or safety-critical systems or equipment, nor in applications where failure or malfunction of an Nexperia product can reasonably be expected to result in personal

injury, death or severe property or environmental damage. Nexperia and its suppliers accept no liability for inclusion and/or use of Nexperia products in such equipment or applications and therefore such inclusion and/or use is at the customer's own risk.

**Quick reference data** — The Quick reference data is an extract of the product data given in the Limiting values and Characteristics sections of this document, and as such is not complete, exhaustive or legally binding.

**Applications** — Applications that are described herein for any of these products are for illustrative purposes only. Nexperia makes no representation or warranty that such applications will be suitable for the specified use without further testing or modification.

Customers are responsible for the design and operation of their applications and products using Nexperia products, and Nexperia accepts no liability for any assistance with applications or customer product design. It is customer's sole responsibility to determine whether the Nexperia product is suitable and fit for the customer's applications and products planned, as well as for the planned application and use of customer's third party customer(s). Customers should provide appropriate design and operating safeguards to minimize the risks associated with their applications and products.

Nexperia does not accept any liability related to any default, damage, costs or problem which is based on any weakness or default in the customer's applications or products, or the application or use by customer's third party customer(s). Customer is responsible for doing all necessary testing for the customer's applications and products using Nexperia products in order to avoid a default of the applications and the products or of the application or use by customer's third party customer(s). Nexperia does not accept any liability in this respect.

**Limiting values** — Stress above one or more limiting values (as defined in the Absolute Maximum Ratings System of IEC 60134) will cause permanent damage to the device. Limiting values are stress ratings only and (proper) operation of the device at these or any other conditions above those given in the Recommended operating conditions section (if present) or the Characteristics sections of this document is not warranted. Constant or repeated exposure to limiting values will permanently and irreversibly affect the quality and reliability of the device.

**Terms and conditions of commercial sale** — Nexperia products are sold subject to the general terms and conditions of commercial sale, as published at <http://www.nexperia.com/profile/terms>, unless otherwise agreed in a valid written individual agreement. In case an individual agreement is concluded only the terms and conditions of the respective agreement shall apply. Nexperia hereby expressly objects to applying the customer's general terms and conditions with regard to the purchase of Nexperia products by customer.

**No offer to sell or license** — Nothing in this document may be interpreted or construed as an offer to sell products that is open for acceptance or the grant, conveyance or implication of any license under any copyrights, patents or other industrial or intellectual property rights.

**Export control** — This document as well as the item(s) described herein may be subject to export control regulations. Export might require a prior authorization from competent authorities.

**Non-automotive qualified products** — Unless this data sheet expressly states that this specific Nexperia product is automotive qualified, the product is not suitable for automotive use. It is neither qualified nor tested in accordance with automotive testing or application requirements. Nexperia accepts no liability for inclusion and/or use of non-automotive qualified products in automotive equipment or applications.

In the event that customer uses the product for design-in and use in automotive applications to automotive specifications and standards, customer (a) shall use the product without Nexperia's warranty of the product for such automotive applications, use and specifications, and (b) whenever customer uses the product for automotive applications beyond Nexperia's specifications such use shall be solely at customer's own risk, and (c) customer fully indemnifies Nexperia for any liability, damages or failed product claims resulting from customer design and use of the product for automotive applications beyond Nexperia's standard warranty and Nexperia's product specifications.

**Translations** — A non-English (translated) version of a document is for reference only. The English version shall prevail in case of any discrepancy between the translated and English versions.

### Trademarks

Notice: All referenced brands, product names, service names and trademarks are the property of their respective owners.

## Contents

---

<b>1. General description</b> .....	<b>1</b>
<b>2. Features and benefits</b> .....	<b>1</b>
<b>3. Ordering information</b> .....	<b>1</b>
<b>4. Marking</b> .....	<b>2</b>
<b>5. Functional diagram</b> .....	<b>2</b>
<b>6. Pinning information</b> .....	<b>2</b>
6.1. Pinning.....	2
6.2. Pin description.....	3
<b>7. Functional description</b> .....	<b>3</b>
<b>8. Limiting values</b> .....	<b>4</b>
<b>9. Recommended operating conditions</b> .....	<b>4</b>
<b>10. Static characteristics</b> .....	<b>5</b>
10.1. Test circuits.....	5
10.2. ON resistance.....	6
10.3. ON resistance test circuit and graphs.....	7
<b>11. Dynamic characteristics</b> .....	<b>9</b>
11.1. Waveforms and test circuit.....	10
11.2. Additional dynamic characteristics.....	11
11.3. Test circuits.....	13
<b>12. Package outline</b> .....	<b>15</b>
<b>13. Abbreviations</b> .....	<b>21</b>
<b>14. Revision history</b> .....	<b>21</b>
<b>15. Legal information</b> .....	<b>22</b>

---

© Nexperia B.V. 2022. All rights reserved

For more information, please visit: <http://www.nexperia.com>

For sales office addresses, please send an email to: [salesaddresses@nexperia.com](mailto:salesaddresses@nexperia.com)

Date of release: 16 August 2022

---