

■ NPN Transistors

S

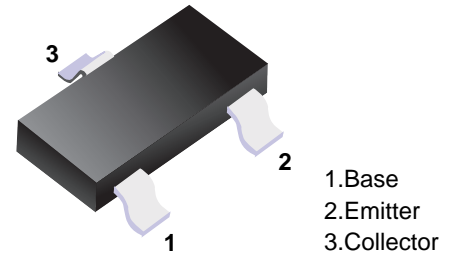

■ Simplified outline(SOT-23)

■ Features

- High DC current gain
- Low saturation voltage
- Complementary to 2SA1298

■ Absolute Maximum Ratings Ta = 25°C

Parameter	Symbol	Rating	Unit
Collector - Base Voltage	V _{CB0}	30	V
Collector - Emitter Voltage	V _{CEO}	25	
Emitter - Base Voltage	V _{EB0}	5	
Collector Current - Continuous	I _C	800	mA
Base Current	I _B	160	
Collector Power Dissipation	P _C	200	mW
Junction Temperature	T _J	150	°C
Storage Temperature Range	T _{stg}	-55 to 150	

■ Electrical Characteristics Ta = 25°C

Parameter	Symbol	Test Conditions	Min	Typ	Max	Unit
Collector-base breakdown voltage	V _{CB0}	I _C = 100 μA, I _E = 0	30			V
Collector- emitter breakdown voltage	V _{CEO}	I _C = 10 mA, I _B = 0	25			
Emitter - base breakdown voltage	V _{EB0}	I _E = 100 μA, I _C = 0	5			
Collector-base cut-off current	I _{CB0}	V _{CB} = 30 V, I _E = 0			0.1	μA
Emitter cut-off current	I _{EB0}	V _{EB} = 5V, I _C =0			0.1	
Collector-emitter saturation voltage	V _{CE(sat)}	I _C = 500 mA, I _B =20 mA			0.4	V
Base - emitter saturation voltage	V _{BE(sat)}	I _C = 500 mA, I _B =20 mA		0.72	1	
Base - emitter voltage	V _{BE}	V _{CE} = 1V, I _C = 10mA	0.5		0.8	
DC current gain	h _{FE}	V _{CE} = 1V, I _C = 100mA	100		320	
		V _{CE} = 1V, I _C = 800mA	40			
Collector output capacitance	C _{ob}	V _{CB} = 10V, I _E =0, f=1MHz		13		pF
Transition frequency	f _T	V _{CE} = 5V, I _C = 10mA		120		MHz

■ Classification of h_{FE}(1)

Type	2SC3265-O	2SC3265-Y
Range	100-200	160-320
Marking	EO	EY

■ Typical Characteristics

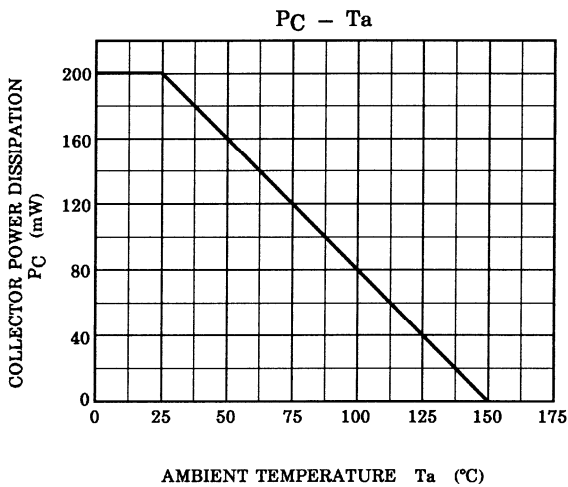
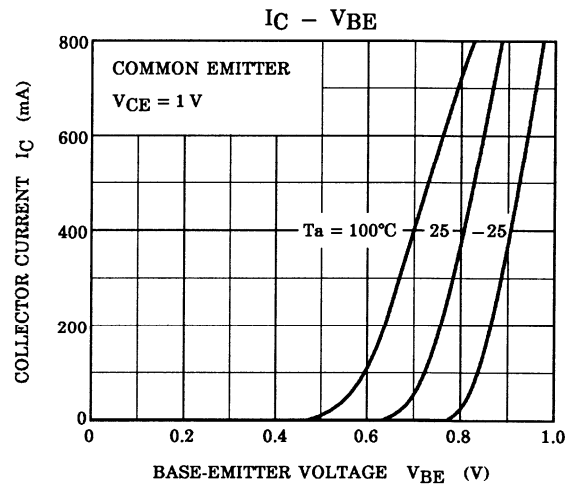
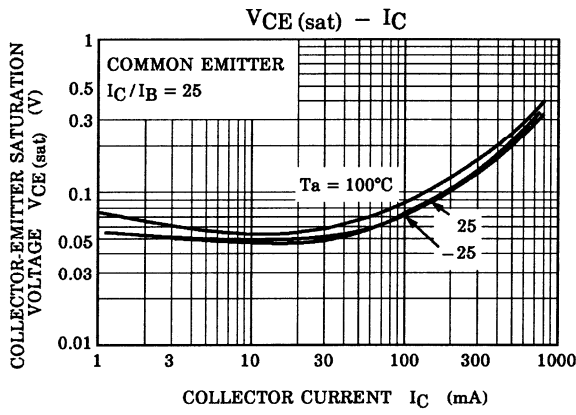
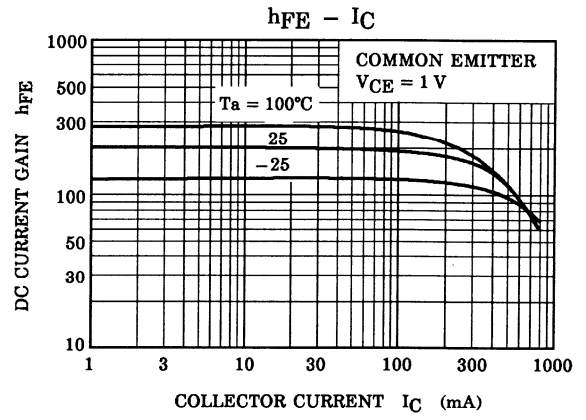
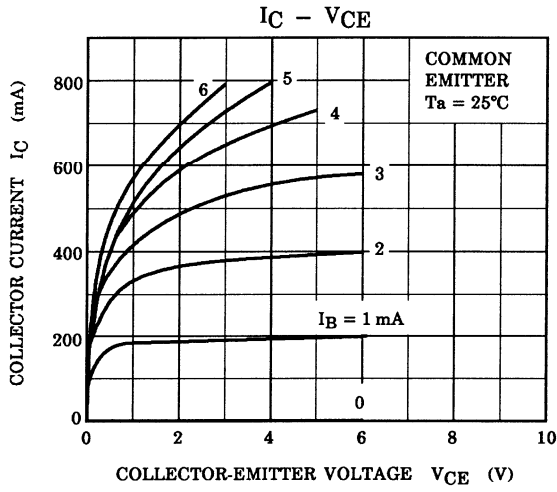

Package Outline

SOT-23

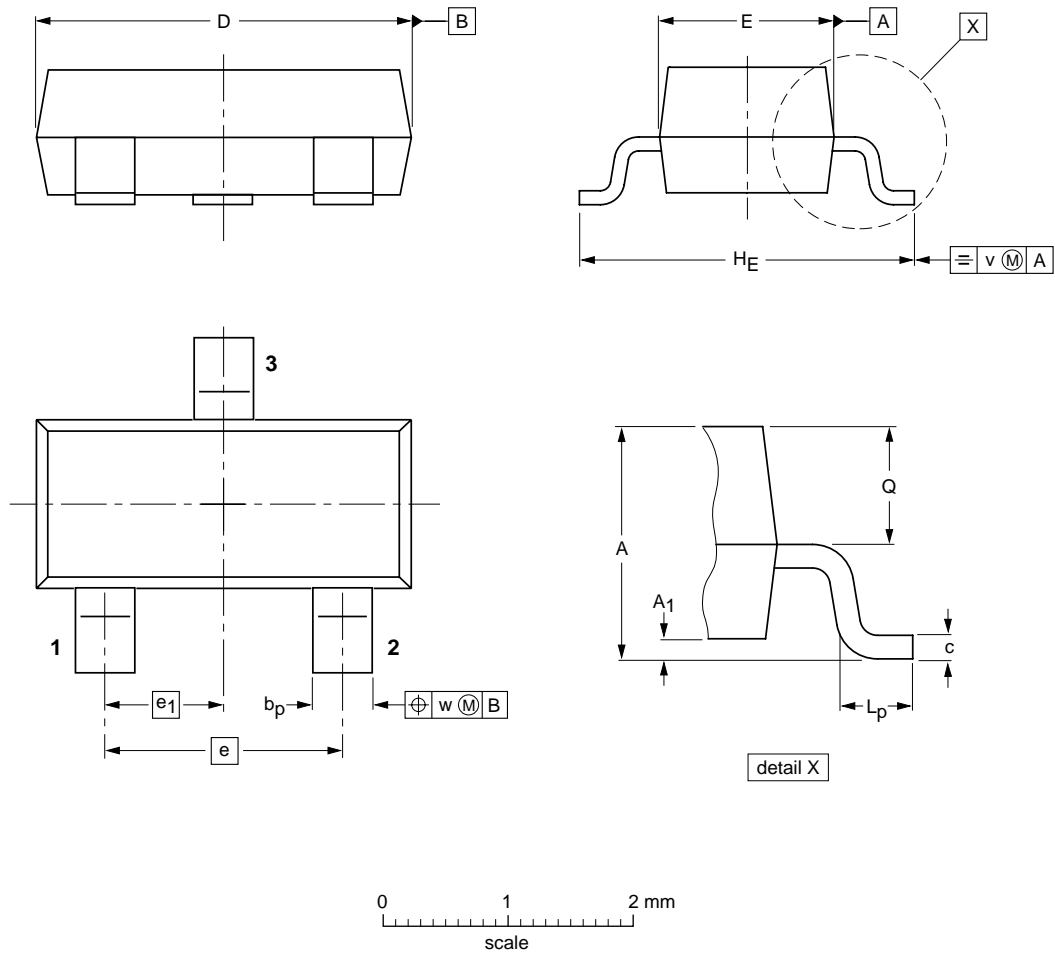

DIMENSIONS (mm are the original dimensions)

UNIT	A	A ₁ max.	b _p	c	D	E	e	e ₁	H _E	L _p	Q	v	w
mm	1.1 0.9	0.1	0.48 0.38	0.15 0.09	3.0 2.8	1.4 1.2	1.9	0.95	2.5 2.1	0.45 0.15	0.55 0.45	0.2	0.1

Summary of Packing Options

Package	Packing Description	Packing Quantity	Industry Standard
SOT-23	Tape/Reel, 7" reel	3000	EIA-481-1