



2SJ652

P-Channel Power MOSFET -60V, -28A, 38mΩ, TO-220F-3SG

ON Semiconductor®

<http://onsemi.com>

Features

- ON-resistance $R_{DS(on)1}=28.5\text{m}\Omega(\text{typ.})$
- Input capacitance $C_{iss}=4360\text{pF}(\text{typ.})$
- 4V drive

Specifications

Absolute Maximum Ratings at $T_a=25^\circ\text{C}$

| Parameter | Symbol | Conditions | Ratings | Unit |
|------------------------------------|-----------|---|-------------|------------------|
| Drain-to-Source Voltage | V_{DSS} | | -60 | V |
| Gate-to-Source Voltage | V_{GSS} | | ± 20 | V |
| Drain Current (DC) | I_D | | -28 | A |
| Drain Current (Pulse) | I_{DP} | $PW \leq 10\mu\text{s}$, duty cycle $\leq 1\%$ | -112 | A |
| Allowable Power Dissipation | PD | | 2.0 | W |
| | | $T_c=25^\circ\text{C}$ | 30 | W |
| Channel Temperature | T_{ch} | | 150 | $^\circ\text{C}$ |
| Storage Temperature | T_{stg} | | -55 to +150 | $^\circ\text{C}$ |
| Avalanche Energy (Single Pulse) *1 | EAS | | 343 | mJ |
| Avalanche Current *2 | I_{AV} | | -28 | A |

Note : *1 $V_{DD}=-30\text{V}$, $L=500\mu\text{H}$, $I_{AV}=-28\text{A}$ (Fig.1)*2 $L \leq 500\mu\text{H}$, single pulse

Stresses exceeding Maximum Ratings may damage the device. Maximum Ratings are stress ratings only. Functional operation above the Recommended Operating Conditions is not implied. Extended exposure to stresses above the Recommended Operating Conditions may affect device reliability.

Package Dimensions

unit : mm (typ)

7529-001

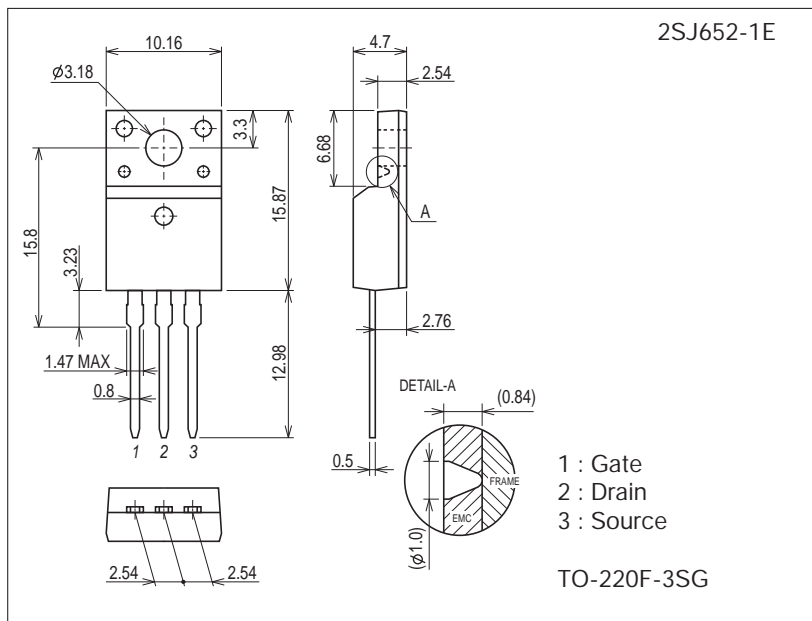

Product & Package Information

- Package : TO-220F-3SG
- JEITA, JEDEC : SC-67
- Minimum Packing Quantity : 50 pcs./magazine

Marking

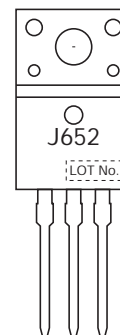

Electrical Connection

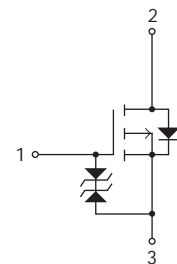

2SJ652

Electrical Characteristics at Ta=25°C

| Parameter | Symbol | Conditions | Ratings | | | Unit |
|--|----------------------|--|---|------|-------|------|
| | | | min | typ | max | |
| Drain-to-Source Breakdown Voltage | V(BR)DSS | I _D =-1mA, V _{GS} =0V | -60 | | | V |
| Zero-Gate Voltage Drain Current | I _{DSS} | V _{DS} =-60V, V _{GS} =0V | | | -1 | μA |
| Gate-to-Source Leakage Current | I _{GSS} | V _{GS} =±16V, V _{DS} =0V | | | ±10 | μA |
| Cutoff Voltage | V _{GS(off)} | V _{DS} =-10V, I _D =-1mA | -1.2 | | -2.6 | V |
| Forward Transfer Admittance | y _{fs} | V _{DS} =-10V, I _D =-14A | 18 | 26 | | S |
| Static Drain-to-Source On-State Resistance | R _{DS(on)1} | I _D =-14A, V _{GS} =-10V | | 28.5 | 38 | mΩ |
| | R _{DS(on)2} | I _D =-14A, V _{GS} =-4V | | 39 | 55.5 | mΩ |
| Input Capacitance | C _{iss} | V _{DS} =-20V, f=1MHz | | 4360 | | pF |
| Output Capacitance | C _{oss} | | | 470 | | pF |
| Reverse Transfer Capacitance | C _{rss} | | | 335 | | pF |
| Turn-ON Delay Time | t _{d(on)} | | | 33 | | ns |
| Rise Time | t _r | See Fig.2 | | 210 | | ns |
| Turn-OFF Delay Time | t _{d(off)} | | | 310 | | ns |
| Fall Time | t _f | | | 180 | | ns |
| Total Gate Charge | Q _g | | | 80 | | nC |
| Gate-to-Source Charge | Q _{gs} | V _{DS} =-30V, V _{GS} =-10V, I _D =-28A | | 15 | | nC |
| Gate-to-Drain "Miller" Charge | Q _{gd} | | | 12 | | nC |
| Diode Forward Voltage | V _{SD} | | I _S =-28A, V _{GS} =0V | | -0.96 | -1.2 |

Fig.1 Avalanche Resistance Test Circuit

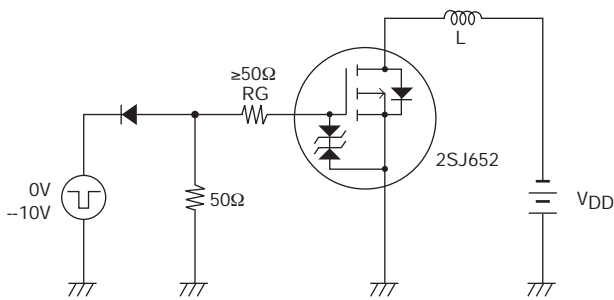
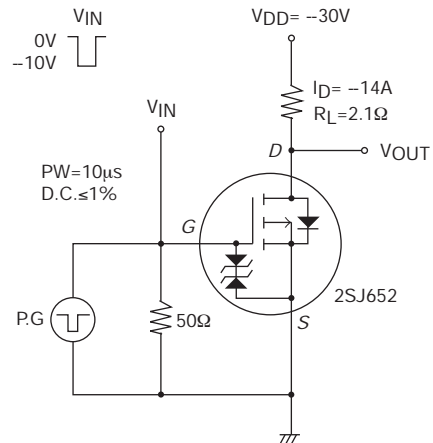
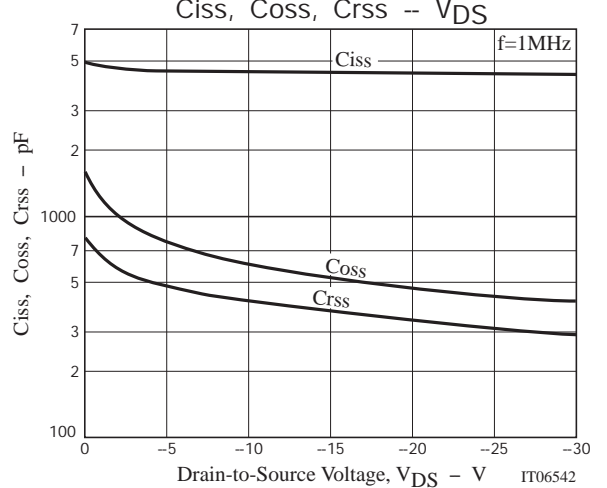
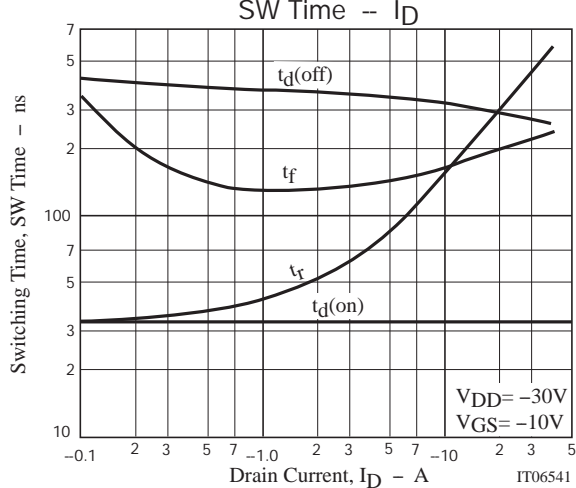
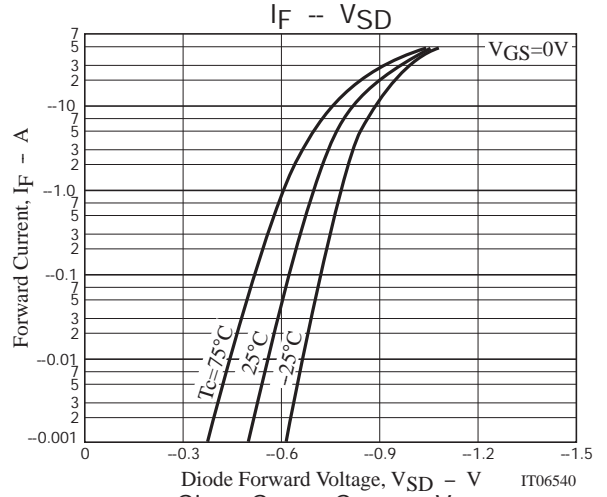
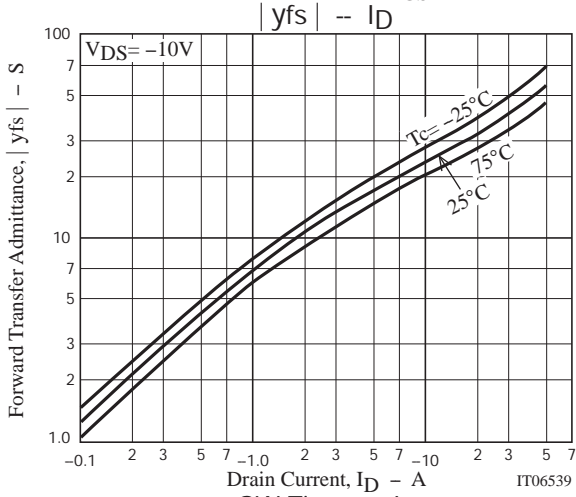
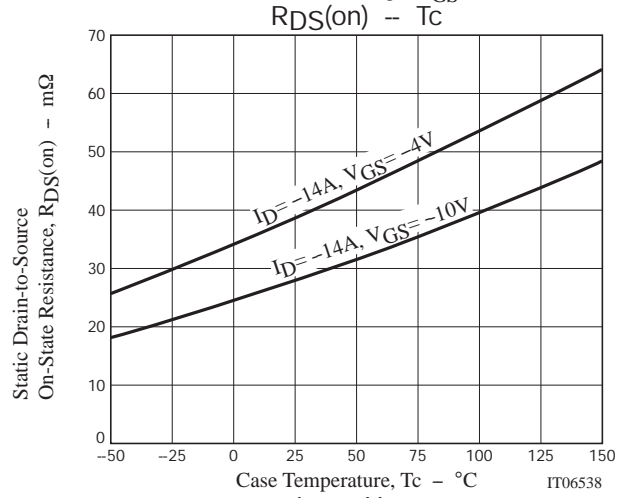
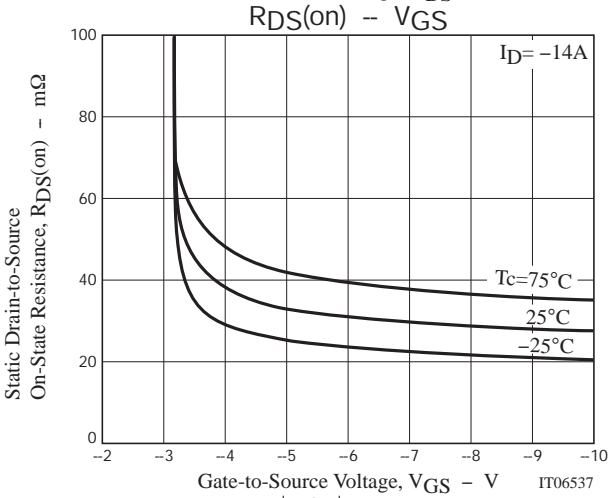
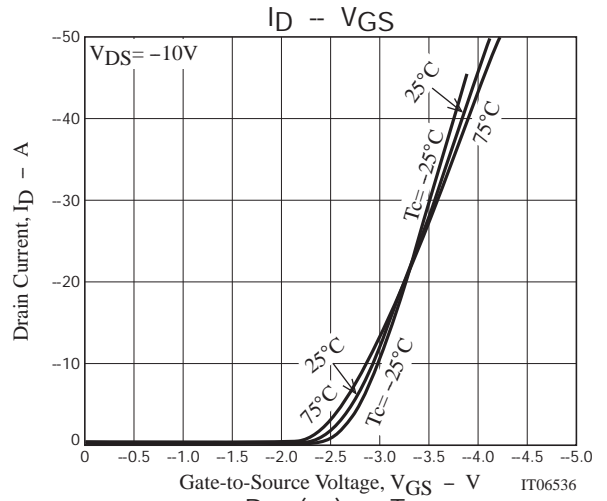
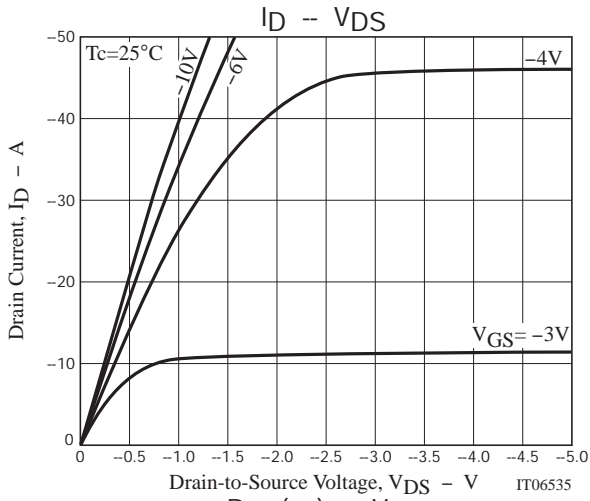

Fig.2 Switching Time Test Circuit



Ordering Information

| Device | Package | Shipping | memo |
|-----------|-------------|-----------------|---------|
| 2SJ652-1E | TO-220F-3SG | 50pcs./magazine | Pb Free |



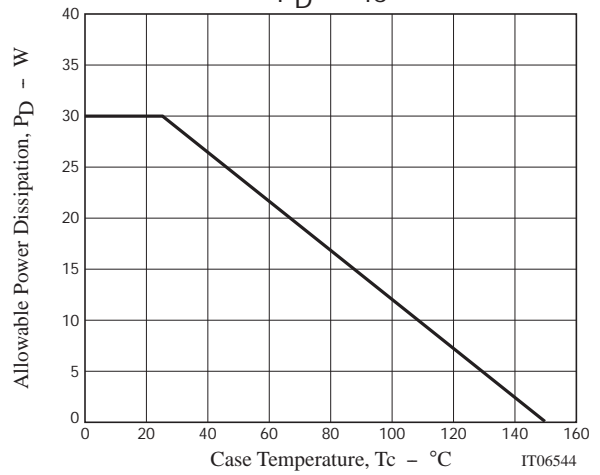
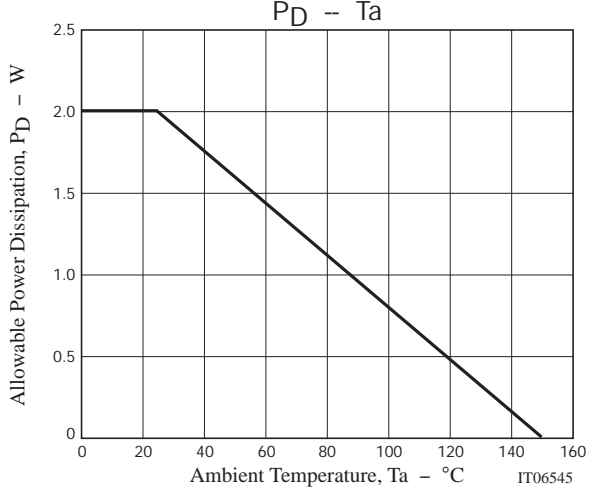
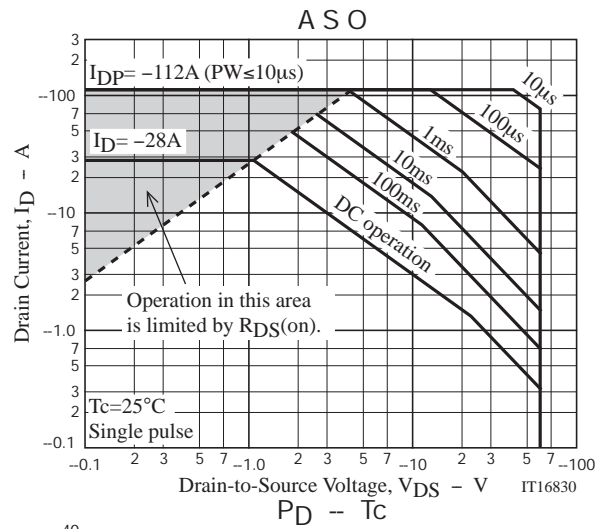
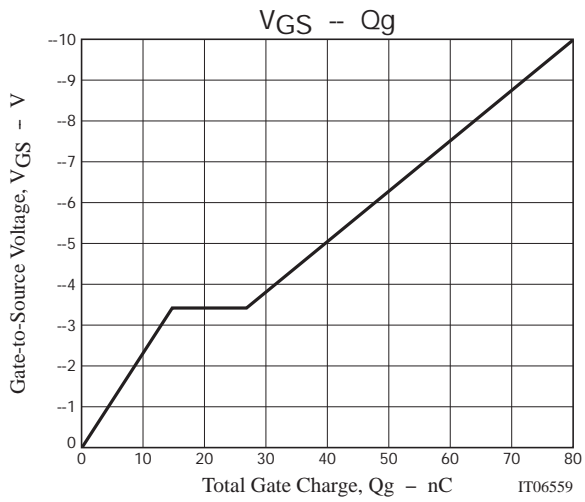

Magazine Specification

2SJ652-1E

1. Packing Format

| Package Name | Magazine Name | Maximum Number of devices contained (pcs) | | | Packing format | |
|--------------|---------------|---|-----------|-----------|--|--|
| | | Magazine | Inner box | Outer box | Inner BOX | Outer BOX |
| TO-220F-3SG | TO-220F | 50 | 1,000 | 4,000 | SPD-0V0001 20 magazines contained Dimensions:mm (external) 568×150×55 | SPT-081029 4 inner boxes contained Dimensions:mm (external) 590×225×178 |

2. Magazine dimensions

(unit:mm)

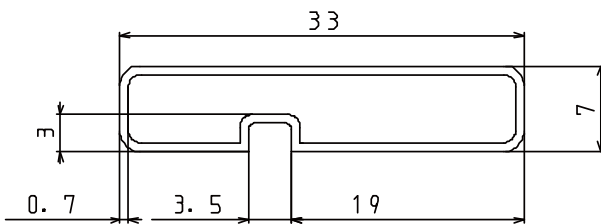

Tolerance=±0.3mm
 Thickness=0.7±0.2mm
 Length =532.5±2mm
 Material =PVC (Antistatic treatment)

3. Storage method to magazine

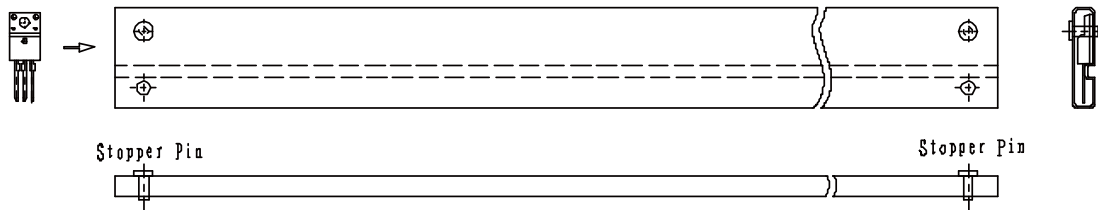

4. Inner box label (unit:mm)

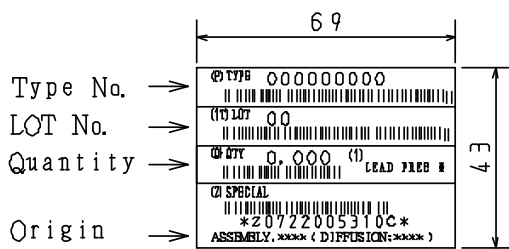

5. Outer box label (unit:mm)

It is a label at the time of factory shipments.
 The form of a label may change in physical
 distribution process.

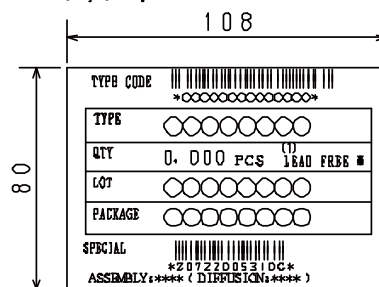

NOTE (1)

The LEAD FREE * description shows that the surface treatment of the terminal is lead free.

| Label | JEITA Phase |
|-------------|----------------|
| LEAD FREE 3 | JEITA Phase 3A |

Outline Drawing

2SJ652-1E

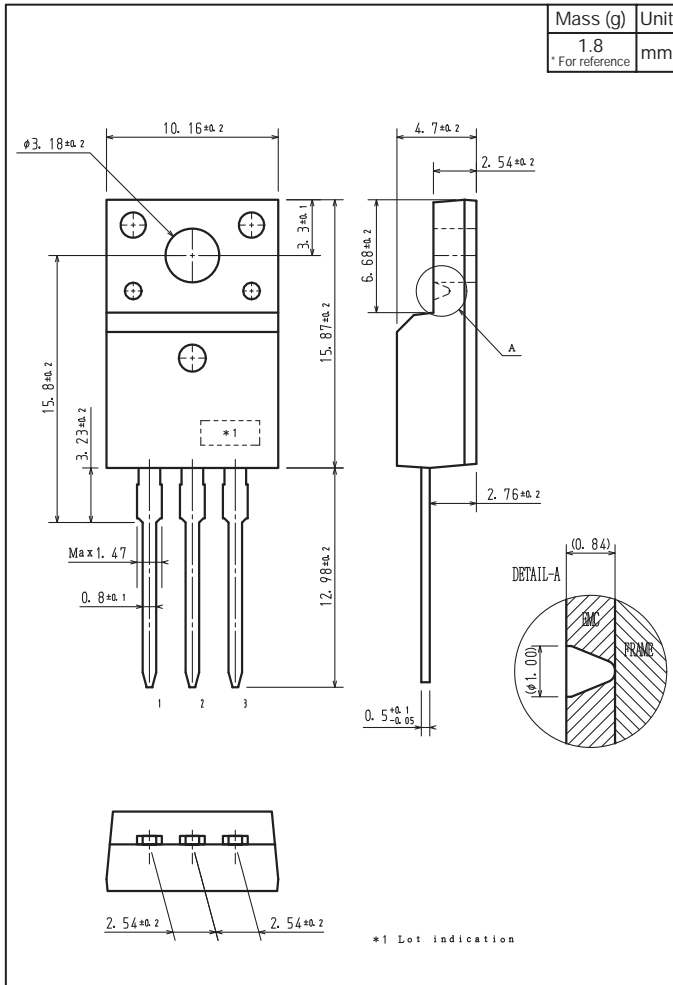

Note on usage : Since the 2SJ652 is a MOSFET product, please avoid using this device in the vicinity of highly charged objects.

ON Semiconductor and the ON logo are registered trademarks of Semiconductor Components Industries, LLC (SCILLC). SCILLC owns the rights to a number of patents, trademarks, copyrights, trade secrets, and other intellectual property. A listing of SCILLC's product/patent coverage may be accessed at www.onsemi.com/site/pdf/Patent-Marking.pdf. SCILLC reserves the right to make changes without further notice to any products herein. SCILLC makes no warranty, representation or guarantee regarding the suitability of its products for any particular purpose, nor does SCILLC assume any liability arising out of the application or use of any product or circuit, and specifically disclaims any and all liability, including without limitation special, consequential or incidental damages. "Typical" parameters which may be provided in SCILLC data sheets and/or specifications can and do vary in different applications and actual performance may vary over time. All operating parameters, including "Typicals" must be validated for each customer application by customer's technical experts. SCILLC does not convey any license under its patent rights nor the rights of others. SCILLC products are not designed, intended, or authorized for use as components in systems intended for surgical implant into the body, or other applications intended to support or sustain life, or for any other application in which the failure of the SCILLC product could create a situation where personal injury or death may occur. Should Buyer purchase or use SCILLC products for any such unintended or unauthorized application, Buyer shall indemnify and hold SCILLC and its officers, employees, subsidiaries, affiliates, and distributors harmless against all claims, costs, damages, and expenses, and reasonable attorney fees arising out of, directly or indirectly, any claim of personal injury or death associated with such unintended or unauthorized use, even if such claim alleges that SCILLC was negligent regarding the design or manufacture of the part. SCILLC is an Equal Opportunity/Affirmative Action Employer. This literature is subject to all applicable copyright laws and is not for resale in any manner.