

Model 1825, 4897, 4899, 6545
Standard Banana Plug, Solderless and Stackable

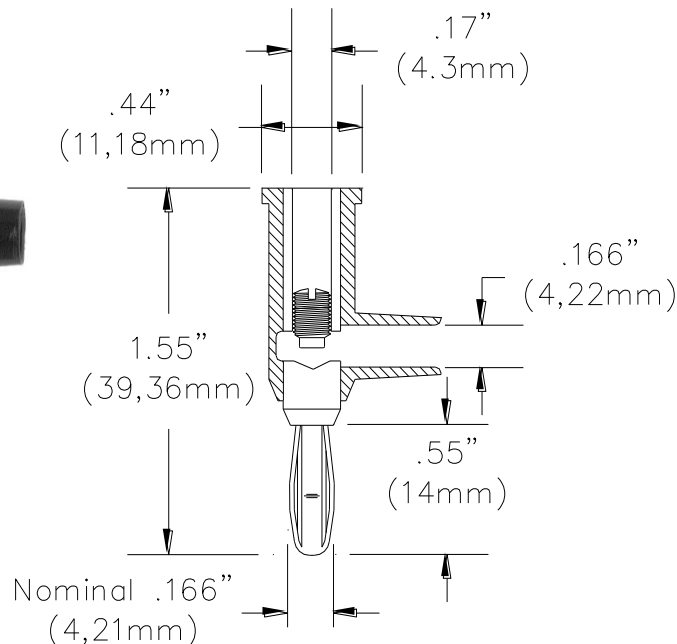

Features

- Designed to fit on the end of any 22 AWG to 18 AWG wire.
- Cross hole wire entry fits wires up to .12" (3mm) diameter.
- Available with tarnish resistant nickel or gold plating for very low contact resistance.
- Model 4899 is rated to temperatures up to +302°F (+150°C).
- Set screw simplifies assembly of test leads and jumpers by using a flat blade screwdriver.
- Fits standard panel and binding post banana jacks .161" to .166" (4,0mm to 4,2mm) diameter.



Materials

- Banana Jack: Beryllium Copper, Gold Plated
 Banana Plug: *Body* – Brass, Nickel Plated (Model 4897 is Gold Plated)
Spring – Beryllium Copper, Nickel Plated (Model 4897 Gold Plated)
 Insulation: Polypropylene (Model 4899 is Polyphenylene Sulfide)
 Set Screw: Steel, Zinc Plated, 8-32 Single Slot

Ratings

- Voltage: For *CE compliance* and for personal safety, do not hold in hand when voltages exceed 33 Vrms/70 Vdc. Maximum voltage for *hands free use* in controlled testing environments: 5000 Vrms Max. Do not use on circuits where transient stresses can exceed the rated voltage.
- Current: 15 Amps
- Maximum Operating Temperature: +122°F (+50°C) max. (Model 4899: +302°F (+150°C) max.)

Ordering Information

- Model: 1825-**color** Nickel Plated Banana with Polypropylene Insulation
Color: 0=Black, 1=Brown, 2=Red, 3=Orange, 4=Yellow, 5=Green, 6=Blue, 7=Violet, 8=Gray, 9=White, 02=set of Black and Red
 Ordering example: 1825-5 (1825 with Green Polypropylene Insulation)

- Model: 4897-0 Gold Plated Banana Plug with Polypropylene Black Insulation
 Model: 4897-2 Gold Plated Banana Plug with Polypropylene Red Insulation
 Model: 4899-0 Nickel Plated Banana with High Temperature Black Insulation (Polyphenylene Sulfide)
 Model: 4899-6 Nickel Plated Banana with High Temperature Blue Insulation (Polyphenylene Sulfide)
 Model: 6545 Package of ten 1825, one of each color.
 Model: 4914 Replacement Set Screws, package of 100.

USA: Sales: 800-490-2361
 Technical Support: technicalsupport@pomonatest.com
 Fax: 425-446-5844

Europe: 31-(0) 40 2675 150 **International:** 425-446-5500
Where to Buy: www.pomonaelectronics.com

All dimensions are in inches. Tolerances (except noted): .xx = ±.02" (.51 mm), .xxx = ±.005" (.127 mm). All specifications are to the latest revisions. Specifications are subject to change without notice. Registered trademarks are the property of their respective companies.